



GAS



ELEKTRA



WATER



MECHANIEK



GEREEDSCHAP

Reparatie-onderdelen passend voor

STAFF ICE SYSTEM

Het complete assortiment vindt u altijd up-to-date in onze webshop



Fabrikant-catalogussen

Per fabrikant de belangrijkste vervangingsonderdelen en toebehoren overzichtelijk bij elkaar

- ✓ **Compleet assortiment en altijd de actuele apparatuurgegevens in de GEV-Webshop**
- ✓ **Alfabetische Index achter in de catalogus**

GEV-Webshop

www.gev-online.nl



- 🔍 **Artikel als favoriet opslaan**
- 🔍 **Inloggen met E-mailadres en bekende paswoord**
- 🔍 **Bulk bestellen - meerdere artikelen direct in de winkelwagen laden**
- 🔍 **Direct op artikel zoeken zonder je hoeven aan te melden**



verwarmingselementen

toebehoren

asafdichtingen

o-ringen

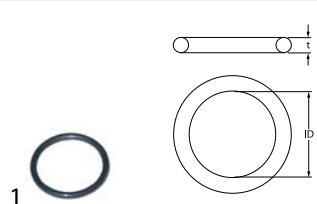

bestelnr.	510072	fabrikantnr.	RICG20141
omschrijving	O-ring EPDM materiaaldikte 3.53mm ID ø 32.93mm vpe 1stuk		

thermostaten

koelingthermostaten

RANCO

serie K50



bestelnr.	390849	fabrikantnr.	SL300350467 SL37AAL3231
omschrijving	thermostaat RANCO type K50-L3231/002 voeler ø 1.9mm voeler Lmm capillaire 1200mm		

serie K61



bestelnr.	390206	fabrikantnr.	4007015000
omschrijving	thermostaat RANCO type K61L1501 voeler ømm voeler Lmm capillaire 1800mm		

schakelaars en tasters

microschakelaars

hendelbediening



bestelnr.	347674	fabrikantnr.	3010314000 3010319000 3010320000 3010321000
omschrijving	microschakelaar 250V 3A 1CO aansluiting vlaksteker 6,3mm L 58mm omgevingstemperatuur max. 85°C bevestigingsafstand 22mm type D42X besturingskracht: 6g hendellengte 44mm		



bestelnr.	345368	fabrikantnr.	90/82010000
omschrijving	microschakelaar met hendel 250V 10A 1CO aansluiting vlaksteker omgevingstemperatuur max. 85°C		



bestelnr.	345367	fabrikantnr.	30/10320000
omschrijving	microschakelaar met hendel 250V 6A 1CO aansluiting vlaksteker 6,3mm L 113mm omgevingstemperatuur max. 85°C bevestigingsafstand 22mm besturingskracht: 40g		



vlotterschakelaars



bestelnr.	347248	fabrikantnr.	90/90611000
omschrijving	microschakelaar 1CO 250V 3A aansluiting vlaksteker 6,3mm met vlotter type D42X omgevingstemperatuur max. 85°C hendellengte 90mm voor serie MP		



			
1			
bestelnr.	379653	fabrikantnr.	3010024000 3010024500 9090611000
omschrijving	vlotterschakelaar 1CO L 90mm inbouw ømm 250V 3A vlaksteker 6,3mm kabellengtemm type D42X omgevingstemperatuur max. 85°C met vlotter voor serie MP		

			
1			
bestelnr.	348026	fabrikantnr.	3010024500 (alt) 90/90612000
omschrijving	vlotterschakelaar set 1CO ø 25mm L 73mm inbouw ø 12mm 250V 10A vlaksteker 6,3mm kabellengte 1380mm		
Reparatie-onderdelen voor	348026		
	bestelnr.	380812	fabrikantnr. —
	vermogensrelais FINDER 230VAC 30A 2CO aansluiting F6,3 overslagbevestiging fabrikant nr. 66.82.8.230.0000		

vlotters

			
1			
bestelnr.	348191	fabrikantnr.	4063018500
omschrijving	vlotter zonder magneet ø 56mm L 135mm B 56mm H 95mm		



			
1			
bestelnr.	348025	fabrikantnr.	90/20364000
omschrijving	vlotter zonder magneet ø 84mm L 84mm B 30mm H 25mm PVC		

relais

vermogensrelais

met steekcontacten

steekcontact 2,0mm

			
1			
bestelnr.	380494	fabrikantnr.	—
omschrijving	vermogensrelais FINDER 230VAC 7A 4CO aansluiting F2 steekaansluiting fabrikant nr. 55.34.8.230.0054 Blokkeerbare testknop + LED (AC) + display 94.74/ZMD4 250V aansluiting 2mm		
Toebehoren voor	380494		
	bestelnr.	380341	fabrikantnr. —
	relaissokkel 4-polig contact 12 300V spanning AC 6A Italiana Relè fabrikant nr. ZMD4		
	bestelnr.	380399	fabrikantnr. —
	relaissokkel 4-polig maat 76,2x27x86,1mm 250V spanning AC 1A FINDER fabrikant nr. 94.94.3		

elektronica

printplaten

			
1			
bestelnr.	403468	fabrikantnr.	30/50048000
omschrijving	bedieningsprintplaat ijsmachine MG14 L 49mm B 25mm passend voor STAFF ICE kabellengte 1400mm vpe 1stuk		



magneetventielen

magneetventielen voor water

ELBI

reparatieonderdelen en toebehoren

verloopstukken

uitgangzijde



1

bestelnr.	371262	fabrikantnr.	4012008000
omschrijving	reducer ELBI type EATON (INVENSYS) doorstroomsnelheid 2.5l/min drukbereik 0 tot 10bar tolerantie ±15/25% oranje		



1

bestelnr.	371260	fabrikantnr.	40/12005000
omschrijving	reducer type ELBI doorstroomsnelheid 0.5l/min drukbereik 0 tot 10bar tolerantie ±15/25% rood		

RPE



1

bestelnr.	374021	fabrikantnr.	4012022000
omschrijving	magneetventiel dubbel recht 230VAC ingang 3/4" uitgang 10mm DN10 RPE		

TP



1

bestelnr.	370017	fabrikantnr.	4012012000
omschrijving	magneetventiel enkel recht 230VAC ingang 3/4" uitgang 11,5mm DN10 TP p max. 10bar		

Reparatie-onderdelen voor 370017

	bestelnr.	371013	fabrikantnr.	—
magneetspoel TP 230VAC 50/60Hz				

Toebehoren voor 370017

	bestelnr.	371220	fabrikantnr.	—
reducer TP doorstroomsnelheid 3l/min rood tolerantie ±15%				

Toebehoren voor	370017			
	bestelnr.	371221	fabrikantnr.	—
reducer TP doorstroomsnelheid 5.5l/min geel tolerantie ±15%				
	bestelnr.	371222	fabrikantnr.	—
reducer TP doorstroomsnelheid 6l/min grijs tolerantie ±15%				
	bestelnr.	371223	fabrikantnr.	—
reducer TP doorstroomsnelheid 10l/min wit tolerantie ±15%				
	bestelnr.	371224	fabrikantnr.	—
reducer TP doorstroomsnelheid 12l/min brons tolerantie ±15%				
	bestelnr.	371225	fabrikantnr.	—
reducer TP doorstroomsnelheid 16l/min lichtbruin tolerantie ±15%				
	bestelnr.	371226	fabrikantnr.	—
reducer TP doorstroomsnelheid 20l/min rood tolerantie ±15%				
	bestelnr.	371230	fabrikantnr.	—
reducer TP doorstroomsnelheid 0.25l/min rood tolerantie ±25%				
	bestelnr.	371231	fabrikantnr.	—
reducer TP doorstroomsnelheid 0.35l/min violet tolerantie ±25%				
	bestelnr.	371232	fabrikantnr.	—
reducer TP doorstroomsnelheid 0.5l/min oranje tolerantie ±25%				
	bestelnr.	371233	fabrikantnr.	—
reducer TP doorstroomsnelheid 0.8l/min wit tolerantie ±25%				
	bestelnr.	371234	fabrikantnr.	—
reducer TP doorstroomsnelheid 1l/min lichtblauw tolerantie ±25%				
	bestelnr.	371235	fabrikantnr.	4012006000
reducer TP doorstroomsnelheid 1.2l/min bruin tolerantie ±25%				
	bestelnr.	371236	fabrikantnr.	—
reducer TP doorstroomsnelheid 1.5l/min lichtbruin tolerantie ±25%				
	bestelnr.	371237	fabrikantnr.	—
reducer TP doorstroomsnelheid 2.5l/min geel tolerantie ±25%				
	bestelnr.	371238	fabrikantnr.	—
reducer TP doorstroomsnelheid 3.4l/min donkergroen tolerantie ±25%				
	bestelnr.	371239	fabrikantnr.	—
reducer TP doorstroomsnelheid 5l/min zwart tolerantie ±25%				
	bestelnr.	371240	fabrikantnr.	—
reducer TP doorstroomsnelheid 8l/min blauw tolerantie ±20%				



reparatieonderdelen en toebehoren

verloopstukken

uitgangzijde



1

bestelnr.	371235	fabrikantnr.	4012006000
omschrijving	reducer TP doorstroomsnelheid 1.2l/min bruin tolerantie ±25%		

metaal

CEME

toebehoren



1

bestelnr.	371154	fabrikantnr.	951342 SL300951342
omschrijving	magneetspoel aansluiting vlaksteker 6,3mm CEME 50Hz 230V H 30mm afname ø 10mm spanning AC		

magneetventielen voor koeling

diversen

ventielhuizen



1

bestelnr.	381437	fabrikantnr.	4011020000
omschrijving	magneetventielhuis enkel type CLS 2,5 p max.bar drukbe-reikbaar aansluiting 6mm		

pressostaten

voor koeltechniek

SAGI NO MIYA



1

bestelnr.	541479	fabrikantnr.	4006013000
omschrijving	pressostaat HD reset automatisch koeltechniek type HTB-X114 aansluiting 2,4mm		

ventilatoren

koelventilatoren

koelmotoren universeel

toebehoren

ventilatorbladen

aluminium



1

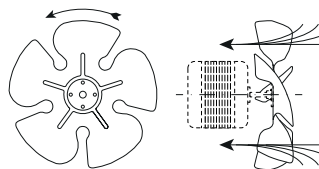

bestelnr.	601387	fabrikantnr.	000233
omschrijving	ventilatorblad zuigend ø 254mm ventilatorblad bevestiging 25.4mm vleugelhoek 34° B 50mm aluminium		



motoren

tandwielmotoren

voor ijsblokjesmachine

voor peddel



1

bestelnr.	501451	fabrikantnr.	90/82011000 908201100
omschrijving	motor FIBER type G025JAMAF00 3.9W 230V 50/60Hz 40U/min schacht ø 12mm voor ijsblokjesmaker motortype M51BJ0R0000		
Toebehoren voor	501451		
	bestelnr.	fabrikantnr.	90/20372000
	houder voor apparaatmotor		



1

bestelnr.	500416	fabrikantnr.	90/82013000
omschrijving	tandwielmotor		



1

bestelnr.	500415	fabrikantnr.	90/82014000
omschrijving	tandwielmotor FIBER type G0251AMAKOO 12V 50/60Hz 30U/min schacht ø 12mm L 76mm B 52mm H 37mm motortype M51B10R0000		



1

bestelnr.	500991	fabrikantnr.	3004010000
omschrijving	tandwielmotor FIBER type GE15JAMAD00 3.9W 230V 50/60Hz 50U/min schacht ø 12mm voor ijsblokjesmaker motortype M51BJ0R0000		
Toebehoren voor	500991		
	bestelnr.	fabrikantnr.	90/20372000
	houder voor apparaatmotor		



1

bestelnr.	500420	fabrikantnr.	90/82012000
omschrijving	tandwielmotor FIBER type W0100ALAD00 230V 50Hz 5U/min schacht ø 12mm L 52mm B 76mm H 52mm motortype M353		



1

bestelnr.	501550	fabrikantnr.	9082013500
omschrijving	tandwielmotor MECHTEX type GB5F 12X 3.9W 230V 50Hz 50U/min schacht ø 12mm voor ijsblokjesmaker		



1

bestelnr.	501549	fabrikantnr.	9082010500
omschrijving	tandwielmotor MECHTEX type GB5F 15 230V 50Hz 40U/min schacht ø 12mm rotatie richting rechtsom		



voor bakken



1

bestelnr.	500402	fabrikantnr.	90/82020000
omschrijving	tandwielmotor KENTA type IC9113065 69W 230V 50Hz 2U/ min schacht ø 14mm B 60mm H 150mm L 150mm		

overigen



1

bestelnr.	500403	fabrikantnr.	90/82016000
omschrijving	tandwielmotor AUTOM 230V 50Hz schacht ø 8mm L 240mm B 130mm H 60mm		

voor drankdispensers



1

bestelnr.	499305	fabrikantnr.	950212 SL300950212
omschrijving	tandwielmotor ELCO 70/60W 230V spanning AC 50/60Hz 32/38U/min schacht ø 6x12mm L 225mm B 75mm H 100mm voor drankdispenser		

pompen

pompen voor ijsblokjesmachines



1

bestelnr.	501465	fabrikantnr.	30/02021000 9082101000
omschrijving	pomp FIR type 4262/48 110W 230V 50/60Hz ingang ø 17mm uitgang ø 17mm L 210mm condensator 5µF		

apparaatspecifieke bouwdeelen
voor ijsblokjesmachine

transmissies

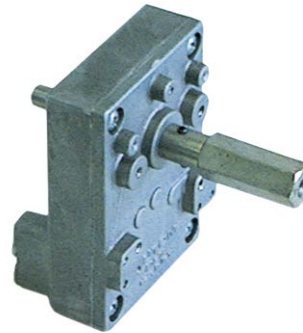

1

bestelnr.	500404	fabrikantnr.	30/05900000
omschrijving	tandwielhuis		

deuren

deuren



1

bestelnr.	694708	fabrikantnr.	90/90852700
omschrijving	deur voor ijsmaker B 275mm H 223mm dikte 29mm zwart		

bak mechanieken

reparatieonderdelen en toebehoren



1

bestelnr.	694707	fabrikantnr.	90/20317000
omschrijving	hevel voor bak L 235mm B 40mm H 74mm passend voor STAFF ICE		



1

bestelnr.	695001	fabrikantnr.	90/70331500
omschrijving	roerspaan met as		





			
1			
bestelnr.	695002	fabrikantnr.	90/70331700
omschrijving	roerspaan met as		

			
1			
bestelnr.	695003	fabrikantnr.	70331800
omschrijving	roerspaan met as		

mechanieken voor verdamperen			
diversen			
			
1			
bestelnr.	696722	fabrikantnr.	951752 SL300951752
omschrijving	bus voor verdamper		

slangen			
slangaansluitingen			
met draad			
			
1			
bestelnr.	695052	fabrikantnr.	40/41319000
omschrijving	slangaansluiting		
Reparatie-onderdelen voor 695052			
	bestelnr.	516026	fabrikantnr. —
	O-ring EPDM materiaaldikte 2.62mm ID ø 17.86mm vpe 1stuk		
	bestelnr.	516109	fabrikantnr. —
	afvoerventiel ID ø 23mm		
	bestelnr.	516110	fabrikantnr. —
	slangaansluiting slang ø 23mm		

vlotters			
vlottercontainers			
			
1			
bestelnr.	695073	fabrikantnr.	90/87016000
omschrijving	vlotterbak		
Reparatie-onderdelen voor 695073			
	bestelnr.	346872	fabrikantnr. —
	microschakelaar met hendel 250V 0.1A 1CO aansluiting vlaksteker 6,3mm L 50mm omgevingstemperatuur max. 85°C bevestigingsafstand 22mm type D41X besturingskracht: 6g hendellengte 36mm		

diversen			
			
1			
bestelnr.	695043	fabrikantnr.	90/20319000 90/78054000
omschrijving	hevel		
			
1			
bestelnr.	694709	fabrikantnr.	90/20352000
omschrijving	houder voor ijsmaker B 18mm H 27mm gat ø 8mm		

voor drankdispensers			
bussen			
			
1			
bestelnr.	650245	fabrikantnr.	SL340001653
omschrijving	bus voor verdamper H 30mm ø 35.5mm D2 ø 21mm		

rubbers			
			
1			
bestelnr.	650163	fabrikantnr.	SL300950258 SL3GS12044A SL3GS24044A
omschrijving	pakking voor afvoer kraan D1 ø 25mm D2 ø 16mm H 21mm silicone		



1

bestelnr.	650220	fabrikantnr.	SL300951857 SL320001630
omschrijving	pakking voor slakken D1 ø 34.5mm D2 ø 26mm ID ø 20mm H 19mm rubber		



1

bestelnr.	650164	fabrikantnr.	950070 SL3GS36007B
omschrijving	pakking voor verdamper D1 ø 170mm ID ø 160mm H 13mm silicone		

voor vaatwassers

deurmechanieken

sluitingen



1

bestelnr.	507011	fabrikantnr.	20/62150000
omschrijving	deursluiting compleet deursluiting		

scharnieren

deurlagers



1

bestelnr.	701167	fabrikantnr.	9016047900
omschrijving	lagerblok L 67mm B 22mm H 8.5mm inbouwpositie onder rechts materiaaldikte 1mm		

rubbers

o-ringen

EPDM

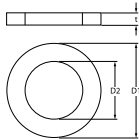
1

bestelnr.	510072	fabrikantnr.	RICG20141
omschrijving	O-ring EPDM materiaaldikte 3.53mm ID ø 32.93mm vpe 1stuk		

siliconen



1

bestelnr.	532250	fabrikantnr.	950194 SL300950194
omschrijving	O-ring silicone materiaaldikte 2.62mm ID ø 17.13mm vpe 10stuk		

aandrijfstechniek en kogellagers

kogellagers

diversen



afbeelding niet beschikbaar

1

bestelnr.	691226	fabrikantnr.	20/08105000
omschrijving	kogellager		



afbeelding niet beschikbaar

1

bestelnr.	691227	fabrikantnr.	20/08110000
omschrijving	kogellager		

aandrijfriemen

V-snaren

Profiel Z/10



1

bestelnr.	697686	fabrikantnr.	20/05010000
omschrijving	V-snaar riembreedte boven 10mm L 520mm H 6mm CODE Z20 1/2 profiel Z/10		



1

bestelnr.	691224	fabrikantnr.	20/05011000
omschrijving	V-snaar riembreedte boven 10mm L 635mm H 6mm CODE Z25 profiel Z/10		



1			
	bestelnr.	691225	fabrikantnr. 20/05012000
omschrijving V-snaar riembreedte boven 10mm L 710mm H 6mm CODE Z28 profiel Z/10			

bevestigingsmaterialen

bevestigingen

borgringen

DIN 471

1			
	bestelnr.	523107	fabrikantnr. SL300950254
omschrijving zekering schacht ø 11mm materiaaldikte 1mm RVS DIN 471			

B

bevestigingen	11
bevestigingsmaterialen	11
borgringen	11

K

koelingthermostaten	3
koelmotoren universeel	6
koelventilatoren	6

M

magneetventielen	5
microschakelaars	3
motoren	7

O

o-ringen	10
----------	----

P

pompen	8
pompen voor ijsblokjesmachines	8
pressostaten	6

R

relais	4
--------	---

S

schakelaars en tasters	3
------------------------	---

T

thermostaten	3
--------------	---

V

ventilatoren	6
verwarmingselementen	3
vlottereschakelaars	3