



**GAS COMPONENTS**



**ELECTRIC COMPONENTS**



**WATER TECHNOLOGY**



**MECHANICAL COMPONENTS**



**TOOLS**

Spare parts suitable for

**STUDIO 54**

Find the complete and up-to-date range of products in our GEV Webshop



# Manufacturer catalogue

The most important spare parts and accessories arranged clearly for every manufacturer

- ✓ Complete product range and all appliance data always up to date in the GEV Webshop
- ✓ Alphabetical Index at the end of the catalogue

## GEV Webshop

[www.gev-online.co.uk](http://www.gev-online.co.uk)

[www.gev-online.com](http://www.gev-online.com)



- 🔍 Add to Favourites
- 🔍 Sign In with email address and usual password
- 🔍 Easy-order – place several items in your basket at the same time
- 🔍 Quick Item search – no login needed



## heating elements

### heating elements for refrigeration

#### heating elements for defrosting

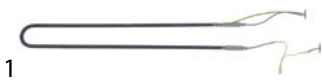

<b>GEV No.</b>	419232	<b>Ref. No.</b>	64740405
<b>description</b>	heating element 150W 230V L 480mm W 60mm tube ø 8.5mm connection length 1450mm defrosting connection 3-wire with fuse t.max. 100°C		

## compressors

### EMBRACO / ASPERA

#### R134A

#### HBP monophase

High evaporation temperature above -15°C



<b>GEV No.</b>	605189	<b>Ref. No.</b>	64850046
<b>description</b>	compressor coolant R134a type EMT6160Z 220-240V 50Hz HBP 7.8kg 1/4HP cylinder capacity 6.76cm <sup>3</sup> CSIR H 166mmWWW 325W 412W 513W 630W 762W 910W ambient temperature max. 45°C		



<b>GEV No.</b>	605209	<b>Ref. No.</b>	64850086
<b>description</b>	compressor coolant R134a type NEK6187Z-A 220-240V 50Hz HBP 11kg 1/3HP cylinder capacity 10cm <sup>3</sup> CSIR H 200mmWWW 365W 482W 624W 791W 983W 1201W test method EN 12900 ambient temperature max. 55°C		



<b>GEV No.</b>	605079	<b>Ref. No.</b>	64850040
<b>description</b>	compressor coolant R134a type NT6215Z 220-240V 50Hz HBP fully hermetic 17kg 1/2HP cylinder capacity 17.4cm <sup>3</sup> CSIR H 207mmWWW 484W 646W 843W 1071W 1326W 1606W test method EN 12900		

#### R404a/R507

#### LBP monophase

Lower evaporation temperature below -20°C



<b>GEV No.</b>	605260	<b>Ref. No.</b>	64850045
<b>description</b>	compressor coolant R404A type NT2192GK 220/240V 50Hz LBP 17.5kg 1.1HP cylinder capacity 22.37cm <sup>3</sup> CSCR 815W 1066W 1361W 1701W 2085WWWWW		

## fans

### refrigeration fans

#### cold air circulating fans (complete)

#### ebm-papst

#### R2E series



<b>GEV No.</b>	601536	<b>Ref. No.</b>	64840010
<b>description</b>	fan R2E190-A026-73 fan wheel ø 190mm blades 6 230V 50/60Hz 58/75W ø 190mm H 70mm 2700rpm cable length 450mm rotation direction right ebm-papst sucking suitable capacitor 2µF		

<b>spare parts for</b>	601536		
<b>GEV No.</b>	365170	<b>Ref. No.</b>	—
<b>description</b>	capacitor capacity 2µF 425V tolerance 5% 50/60Hz ambient temperature max. -25 to +85°C ø 25mm L 49mm M8 plastic connection cable 250mm 416.17.74 protection		

## handles and hand wheels

### bracket handles



<b>GEV No.</b>	690451	<b>Ref. No.</b>	64700185
<b>description</b>	pull handle L 426mm H 40mm mounting distance 376mm black		

## hinges

### spring assisted hinges

#### universal

#### INTERKLIMAT

#### hinges

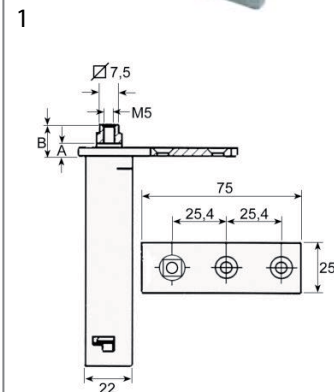

<b>GEV No.</b>	690714	<b>Ref. No.</b>	64700125 64700128 64700160
<b>description</b>	spring assisted hinge series 28XC mounting pos. left/right L 75mm W 25mm H 103mm A 8mm B 11mm intake 7.5x7.5 refrigeration units mounting distance 25mm		

## gaskets

### refrigeration gaskets

#### plug-in gaskets

#### profile 9048

We offer custom-made gaskets for this profile

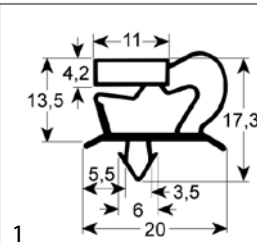

<b>GEV No.</b>	901677	<b>Ref. No.</b>	64700010
<b>description</b>	refrigeration gasket profile 9048 W 650mm L 1550mm plug size		

#### profile 9703

We offer custom-made gaskets for this profile

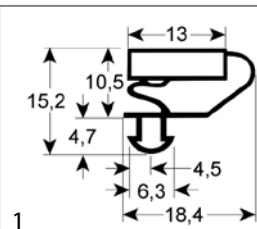

<b>GEV No.</b>	901791	<b>Ref. No.</b>	64600000
<b>description</b>	refrigeration gasket profile 9703 W 659mm L 731mm plug size		

#### profile 9704

We offer custom-made gaskets for this profile

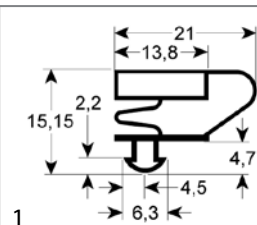

<b>GEV No.</b>	902411	<b>Ref. No.</b>	64691036
<b>description</b>	refrigeration gasket profile 9704 W 285mm L 415mm plug size		

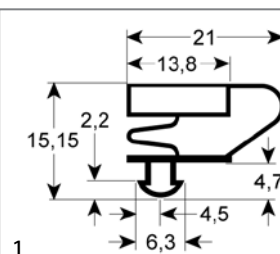

<b>GEV No.</b>	901031	<b>Ref. No.</b>	N/A
<b>description</b>	refrigeration gasket profile 9704 W 295mm L 423mm plug size L1 414mm W1 286mm external size		

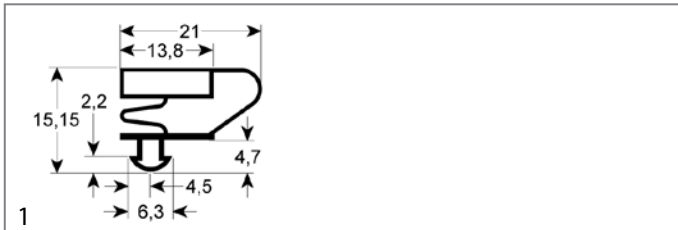

<b>GEV No.</b>	902414	<b>Ref. No.</b>	64691084
<b>description</b>	refrigeration gasket profile 9704 W 395mm L 708mm plug size		

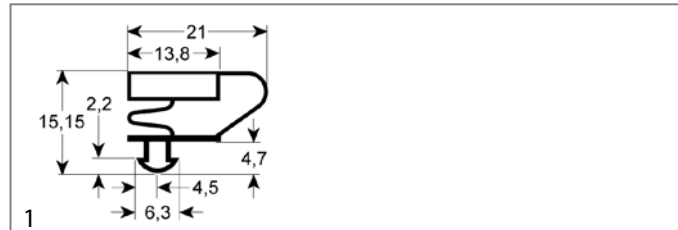

<b>GEV No.</b>	902299	<b>Ref. No.</b>	N/A
<b>description</b>	refrigeration gasket profile 9704 Wmm L 2500mm		

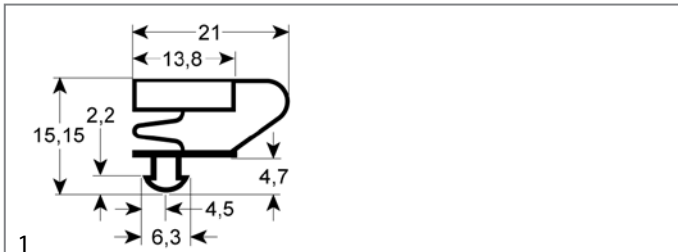

<b>GEV No.</b>	901030	<b>Ref. No.</b>	64691002
<b>description</b>	refrigeration gasket profile 9704 W 423mm L 620mm plug size L1 611mm W1 414mm external size		

**profile 9753**

We offer custom-made gaskets for this profile

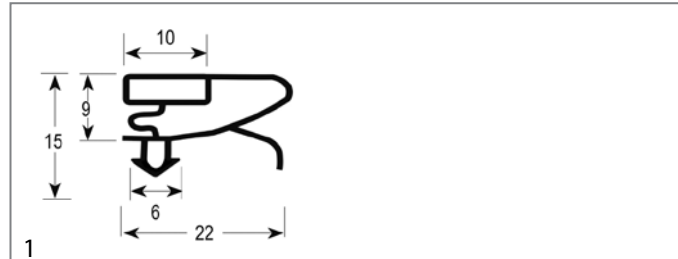

<b>GEV No.</b>	901032	<b>Ref. No.</b>	64691038 N/A
<b>description</b>	refrigeration gasket profile 9753 W 186mm L 423mm plug size		

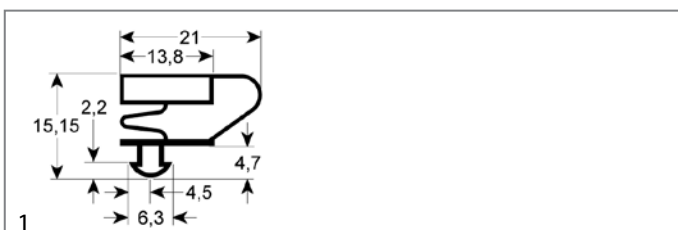

<b>GEV No.</b>	902412	<b>Ref. No.</b>	64691020 64700055
<b>description</b>	refrigeration gasket profile 9704 W 454mm L 533mm plug size		

**evaporation and condensing trays**  
unheated condensing trays



<b>GEV No.</b>	699209	<b>Ref. No.</b>	64860132
<b>description</b>	drip tray L 420mm W 85mm H 35mm for evaporator		

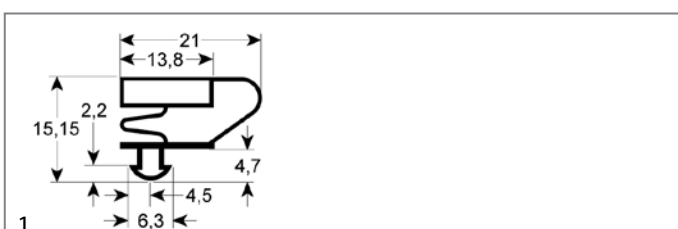

<b>GEV No.</b>	902413	<b>Ref. No.</b>	64691004
<b>description</b>	refrigeration gasket profile 9704 W 475mm L 610mm plug size		

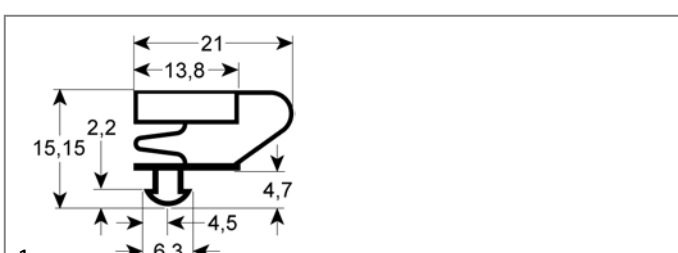

<b>GEV No.</b>	902131	<b>Ref. No.</b>	N/A
<b>description</b>	refrigeration gasket profile 9704 W 669mm L 1552mm plug size		



**C**

cold air circulating fans (complete)	3
compressors	3

**F**

fans	3
------	---

**H**

heating elements	3
heating elements for defrosting	3
heating elements for refrigeration	3

**P**

plug-in gaskets	4
-----------------	---

**R**

refrigeration fans	3
refrigeration gaskets	4

**S**

spring assisted hinges	4
------------------------	---