



GAS COMPONENTS



ELECTRIC COMPONENTS



WATER TECHNOLOGY



MECHANICAL COMPONENTS



TOOLS

Spare parts suitable for

TECNODOM

Find the complete and up-to-date range of products in our GEV Webshop



Manufacturer catalogue

The most important spare parts and accessories arranged clearly for every manufacturer

- ✓ Complete product range and all appliance data always up to date in the GEV Webshop
- ✓ Alphabetical Index at the end of the catalogue

GEV Webshop

www.gev-online.co.uk

www.gev-online.com



- 🔍 Add to Favourites
- 🔍 Sign In with email address and usual password
- 🔍 Easy-order – place several items in your basket at the same time
- 🔍 Quick Item search – no login needed



heating elements

heating elements for refrigeration

heating elements for defrosting



GEV No.	420481	Ref. No.	AF52RESEV0607 RCSE700BTMN
description	heating element 360W 230V L 260mm W 75mm H 42mm connection female faston 6.3mm cable length 900mm tube ø 8.5mm		

heating elements for condensate evaporation



GEV No.	420480	Ref. No.	AF17RESVASC RCVEC92510W
description	heating element 150W 230V L 420mm W 70mm cable length 250mm connection distance 70mm connection male faston 6.3mm tube ø 8.5mm		

heating cables

connection on both sides

with wire end ferrules



GEV No.	420479	Ref. No.	AF10RESPO RFPAC5700
description	heating cable 52W 230V L 5700mm L1 (unheated) 2x730mm L2 (heated) 4240mm silicone ø 2.7mm		

thermostats

control and safety thermostats

CAEM

control thermostats

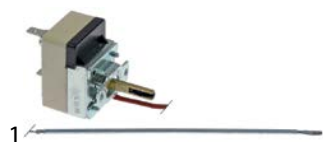

GEV No.	390790	Ref. No.	HETFR50-280
description	thermostat t.max. 300°C temperature range 50-280°C 1-pole 1NO 16A probe ø 3mm probe L 160mm capillary pipe 1450mm capillary pipe isolated 650mm gland nut shaft ø 6x4.6mm shaft L 22mm rotation 270° 250V		

probes

universal probes

temperature probes



GEV No.	379053	Ref. No.	ATserie
description	temperature probe PTC 1kOhm cable PVC probe -50 up to +150°C cable -10 up to 100°C probe ø6x30mm cable length 3m without screw connection 2-wire		

core probes



GEV No.	379549	Ref. No.	SONCU
description	core temperature probe PTC 1kOhm cable PVC probe -50 up to +150°C cable -10 up to 100°C probe ø6x110mm cable length 3.5m handle ø 8mm handle length 120x35mm 2-wire L1 120mm L2 130mm		



producer-specific probes

core probes

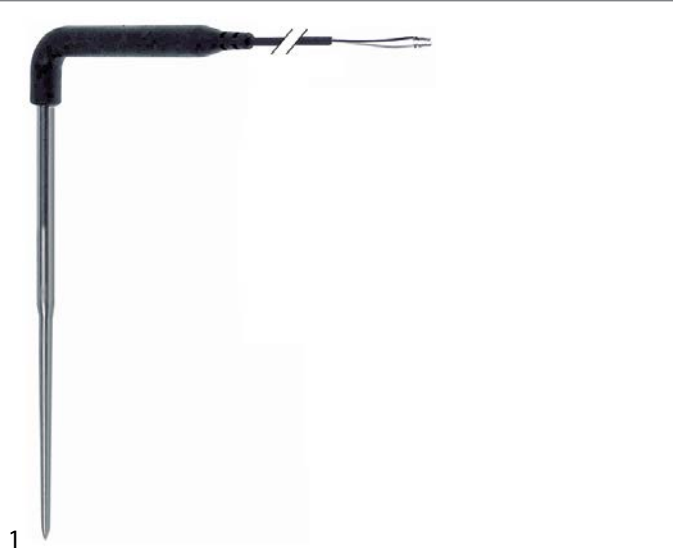

GEV No.	379549	Ref. No.	SONCU
description	core temperature probe PTC 1kOhm cable PVC probe -50 up to +150°C cable -10 up to 100°C probe ø6x110mm cable length 3.5m handle ø8mm handle length 120x35mm 2-wire L1 120mm L2 130mm		

compressors

ACC/ZEL

R404a/R507

HMBP monophase

High/Medium evaporation temperature above -20/-15 °C



GEV No.	605068	Ref. No.	AF82ML45TB AF82ML45TG
description	compressor coolant R404a/R507 type ML45TB 220-240V 50Hz HMBP fully hermetic 10kg 1/5HP cylinder capacity 4.5cm ³ CSIR H 175.5mmW 192W 246W 309W 382W 465W 557W 659W 771W test method ASHRAE		

electronics

PCBs



GEV No.	403887	Ref. No.	ETPVCABT2 SCDAB3/5T
description	electronic controller kit for deep freezer L 105mm W 95mm		



GEV No.	605014	Ref. No.	AF82ML80TB
description	compressor coolant R404a/R507 type ML80TB 220-240V 50Hz HMBP fully hermetic 11.4kg 3/8HP cylinder capacity 7.57cm ³ CSIR H 175.5mmW 261W 346W 446W 561W 691W 835W 993W 1167W test method ASHRAE ambient temperature max. 43°C		





fans

axial fans

import



1

GEV No.	601080 ¹	Ref. No.	VENTILATORECOMP
description	axial fan L 119mm W 119mm H 38mm 230VAC 50/60Hz 23/20W bearing ball bearing connection male faston 2.8mm metal ADDA fan wheel ø 110mm temp.-resist. 70°C		
accessories for	601080		
	GEV No.	550898	Ref. No. —
	connecting cable cable length 2000mm connection F 2.8 connection distance 7.9mm for axial flow fan		
	GEV No.	692519	Ref. No. —
	guard L 120mm W 120mm plastic		

¹with ball bearings

refrigeration fans

refrigeration motors universal

accessories

fan wheels

aluminium

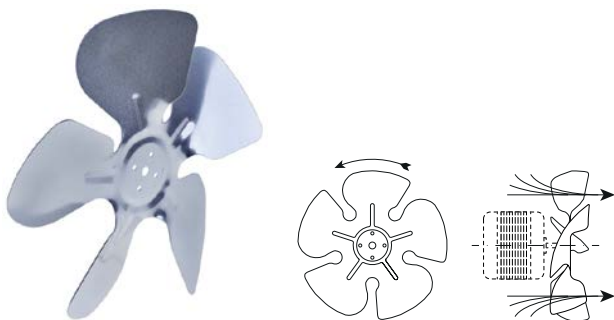

1

GEV No.	601571	Ref. No.	AF83VENCOND
description	fan wheel blowing ø 230mm fan wheel mounting 25.4mm blade angle 28° W 43mm aluminium		

cold air circulating fans (complete)

ebm-papst

A4E series

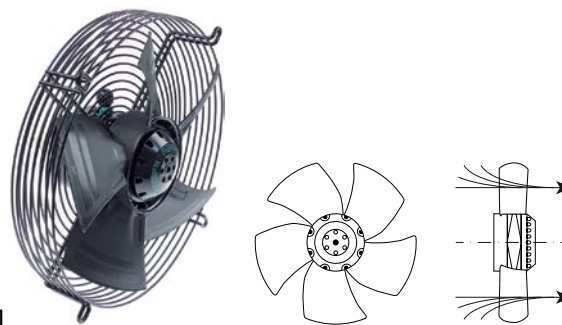

1

GEV No.	602049	Ref. No.	VENTBAST
description	fan A4E300-A572-06 fan wheel ø 300mm blades 5 230V 50/60Hz 72/90W ø 340mm mounting distance 265mm 1320/1500rpm cable lengthmm ebm-papst		

cross flow fans

COPREL

with moulded coils



1

GEV No.	602104	Ref. No.	N/A
description	cross flow fan COPREL FFL roller ø 60mm roller length 240mm laminated core thickness 20mm motor position left 230V/50-60Hz 26W universal bearing silicone connection cable 500mm airflow 149m ³ /h -10 up to +50°C		

hinges

spring assisted hinges

universal

INTERKLIMAT

hinges



1

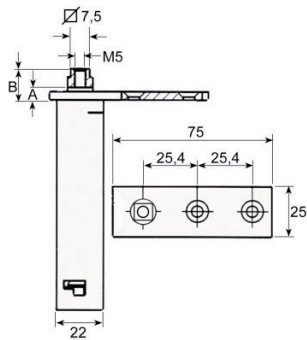

GEV No.	690622	Ref. No.	AF07CERN AF07CERN 10 AFCERN1400
description	spring assisted hinge series 28L mounting pos. left/right L 75mm W 25mm H 103mm A 13mm B 18mm mounting measurements 22x22mm intake 7.5x7.5 refrigeration units		

accessories

miscellaneous



1

GEV No.	701619	Ref. No.	TZXXA056SX
description	bracket for hinge L 120mm		

shelves and shelf rails

grates

universal

without upstand



1

GEV No.	970896	Ref. No.	GRPL600
description	grate W 530mm D 550mm H 10mm plastic-coated steel wire gauge frame 8mm lengthwise wires gauge 3mm crossing wires 2 grey		

shelf rails and supports

producer-specific



1

GEV No.	701483	Ref. No.	GL700
description	pair of setting bar L-shape L 650mm W 24mm H 28mm mounting pos. left/right		



1

GEV No.	692619	Ref. No.	GC700
description	pair of setting bar U-shape L 650mm W 14mm H 28mm mounting pos. left/right		



gaskets

refrigeration gaskets

plug-in gaskets

profile 9048

We offer custom-made gaskets for this profile

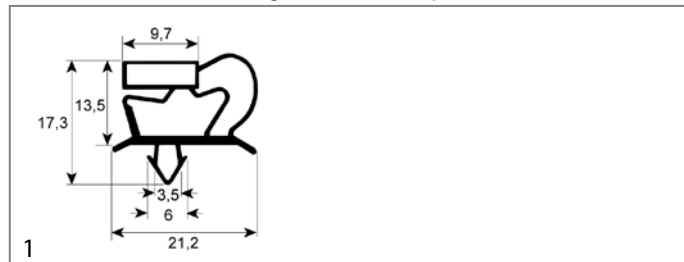

GEV No.	900944	Ref. No.	GC3CTGN
description	refrigeration gasket profile 9048 W 387mm L 177mm plug size		

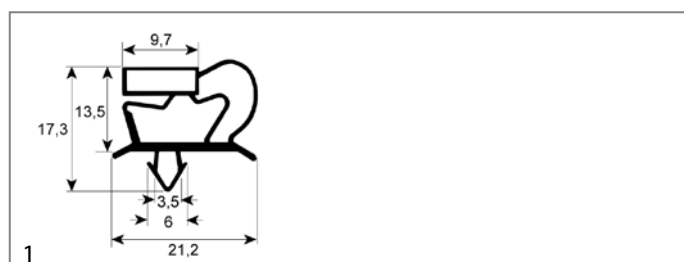

GEV No.	900945	Ref. No.	GC2CTGN
description	refrigeration gasket profile 9048 W 387mm L 292mm plug size		

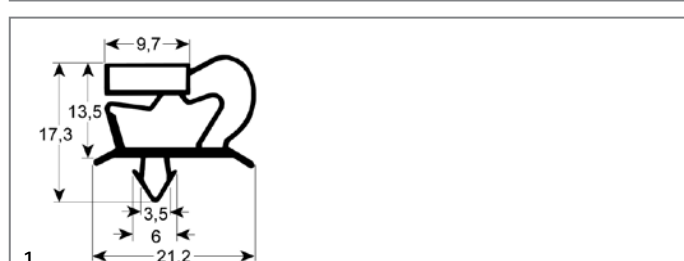

GEV No.	902063	Ref. No.	GPTGN
description	refrigeration gasket profile 9048 W 387mm L 633mm plug size		

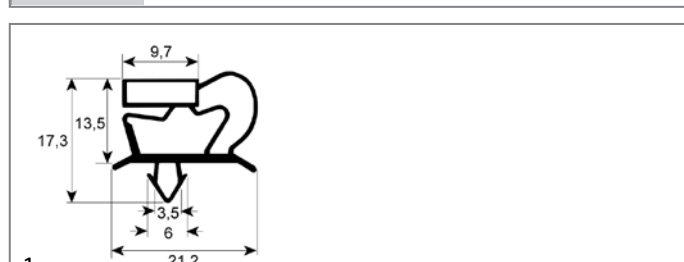

GEV No.	900947	Ref. No.	GPTPA
description	refrigeration gasket profile 9048 W 455mm L 635mm plug size		

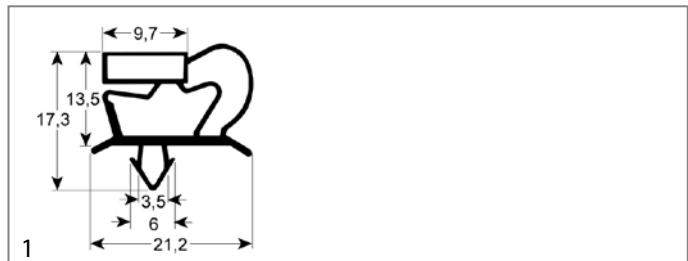

GEV No.	902110	Ref. No.	GPA400
description	refrigeration gasket profile 9048 W 540mm L 1390mm plug size		

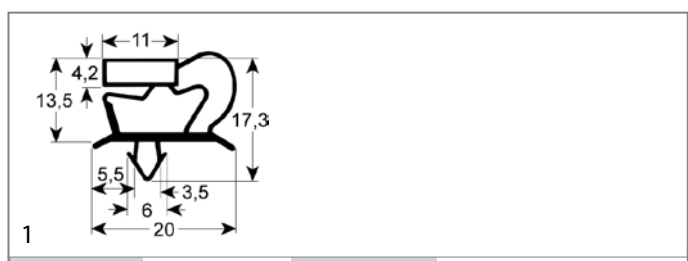

GEV No.	902467	Ref. No.	GSA
description	refrigeration gasket profile 9048 W 621mm L 742mm plug size		

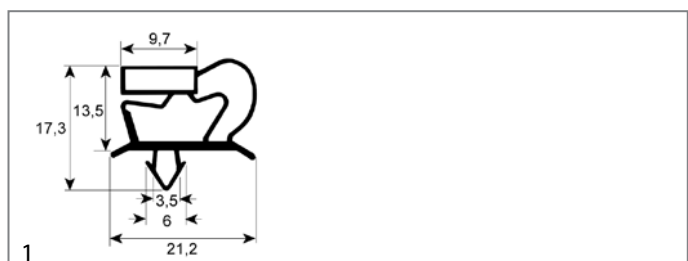

GEV No.	900949	Ref. No.	AF07-013 AF09GUAPO AF14EKOMBT GPA GPA Pos. 13
description	refrigeration gasket profile 9048 W 627mm L 1545mm plug size		

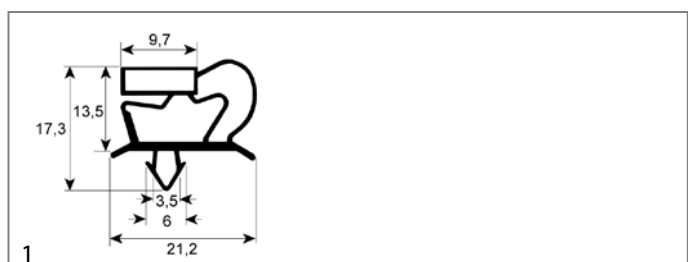

GEV No.	900948	Ref. No.	AF08GUASP AF09GUASP
description	refrigeration gasket profile 9048 W 637mm L 742mm plug size		

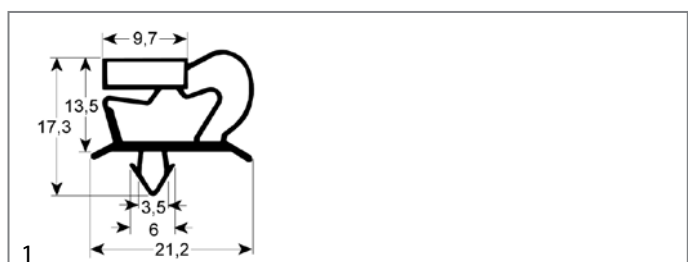

GEV No.	902258	Ref. No.	N/A
description	refrigeration gasket profile 9048 Wmm L 2500mm		

gaskets for heated units

door seals

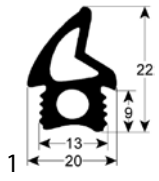

GEV No.	902483	Ref. No.	FO4NEA0039
description	door seal profile 2763 L 1800mm suitable for TECNODOM		

A

axial fans 5

C

cold air circulating fans (complete) 5

compressors 4

core probes 3

cross flow fans 5

D

door seals 8

F

fans 5

G

gaskets for heated units 8

grates 6

H

heating cables 3

heating elements 3

heating elements for condensate evaporation 3

heating elements for defrosting 3

heating elements for refrigeration 3

P

plug-in gaskets 7

probes 3

R

refrigeration fans 5

refrigeration gaskets 7

refrigeration motors universal 5

S

shelves and shelf rails 6

spring assisted hinges 6

T

temperature probes 3

thermostats 3

U

universal probes 3