



GAS



ELEKTRA



WATER



MECHANIEK



GEREEDSCHAP

Reparatie-onderdelen passend voor

TECNODOM

Het complete assortiment vindt u altijd up-to-date in onze webshop



Fabrikant-catalogussen

Per fabrikant de belangrijkste vervangingsonderdelen en toebehoren overzichtelijk bij elkaar

- ✓ **Compleet assortiment en altijd de actuele apparatuurgegevens in de GEV-Webshop**
- ✓ **Alfabetische Index achter in de catalogus**

GEV-Webshop

www.gev-online.nl



- 🔍 **Artikel als favoriet opslaan**
- 🔍 **Inloggen met E-mailadres en bekende paswoord**
- 🔍 **Bulk bestellen - meerdere artikelen direct in de winkelwagen laden**
- 🔍 **Direct op artikel zoeken zonder je hoeven aan te melden**



verwarmingselementen

elementen voor koeltechniek

ontdooielementen



bestelnr.	420481	fabrikantnr.	AF52RESEV0607 RCSE700BTMN
omschrijving	verwarmingselement 360W 230V L 260mm B 75mm H 42mm aansluiting vlakstekkerhuls 6,3mm kabellengte 900mm pijp ø 8.5mm		

ontdooiwaterverwarmingen



bestelnr.	420480	fabrikantnr.	AF17RESVASC RCVEC92510W
omschrijving	verwarmingselement 150W 230V L 420mm B 70mm kabel-lengte 250mm aansluitafstand 70mm aansluiting vlakstekker 6,3mm pijp ø 8.5mm		

verwarmingkabels

aansluiting beide zijden

met adereindhulzen



bestelnr.	420479	fabrikantnr.	AF10RESPO RFPAC5700
omschrijving	verwarmingkabel 52W 230V L 5700mm L1 (onverwamd) 2x730mm L2 (verwamd) 4240mm silicone ø 2.7mm		

thermostaten

regel- en maximaalthermostaten

CAEM

regelthermostaten

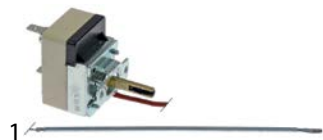

bestelnr.	390790	fabrikantnr.	HETFR50-280
omschrijving	thermostaat t.max. 300°C instelbereik 50-280°C 1-polig 1NO 16A voeler ø 3mm voeler L 160mm capillaire 1450mm capillaire pijp geïsoleerd 650mm stopbus as ø 6x4,6mm as L 22mm rotatiehoek 270° 250V		

voelers

universele voelers

temperatuurvoelers



bestelnr.	379053	fabrikantnr.	ATserie
omschrijving	temperatuurvoeler PTC 1kOhm kabel PVC voeler -50 tot +150°C kabel -10 tot +100°C voeler ø6x30mm kabellengte 3m zonder Schroefaansluiting 2-aderig		

insteekvoeler



bestelnr.	379549	fabrikantnr.	SONCU
omschrijving	kerntemperatuurvoeler PTC 1kOhm kabel PVC voeler -50 tot +150°C kabel -10 tot +100°C voeler ø6x110mm kabel-lengte 3.5m greep ø 8mm greep lengte 120x35mm 2-aderig L1 120mm L2 130mm		



fabrikantspecifieke voelers

insteekvoeler



1

bestelnr.	379549	fabrikantnr.	SONCU
omschrijving	kerntemperatuurvoeler PTC 1kOhm kabel PVC voeler -50 tot +150°C kabel -10 tot +100°C voeler ø6x110mm kabel-lengte 3.5m greep ø8mm greeplengte 120x35mm 2-aderig L1 120mm L2 130mm		

compressoren

ACC/ZEL

R404a/R507

HMBP 1-fase

Hoge verdampingstemperatuur boven -20/-15 °C



1

bestelnr.	605068	fabrikantnr.	AF82ML45TB AF82ML45TG
omschrijving	compressor koelmiddel R404a/R507 type ML45TB 220-240V 50Hz HMBP volledig hermetisch 10kg 1/5HP cilinderinhoud 4.5cm ³ CSIR H 175.5mmW 192W 246W 309W 382W 465W 557W 659W 771W testmethode ASHRAE		

elektronica

printplaten

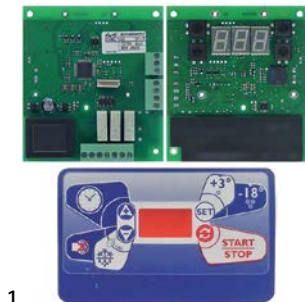

1

bestelnr.	403887	fabrikantnr.	ETPVCABT2 SCDAB3/5T
omschrijving	elektronische regelaar set voor diepvrieskast L 105mm B 95mm		



1

bestelnr.	605014	fabrikantnr.	AF82ML80TB
omschrijving	compressor koelmiddel R404a/R507 type ML80TB 220-240V 50Hz HMBP volledig hermetisch 11.4kg 3/8HP cilinderinhoud 7.57cm ³ CSIR H 175.5mmW 261W 346W 446W 561W 691W 835W 993W 1167W testmethode ASHRAE omgevingstemperatuur max. 43°C		





ventilatoren

axiaalventilatoren

Import



1

bestelnr.	601080 ¹	fabrikantnr.	VENTILATORECOMP
omschrijving	axiaalventilator L 119mm B 119mm H 38mm 230VAC 50/60Hz 23/20W lager kogellager aansluiting vlaksteker 2,8mm metaal ADDA ventilatorblad ø 110mm temp. bestendigheid 70°C		
Toebehoren voor	601080		
	bestelnr.	550898	fabrikantnr. —
	aansluitkabel kabellengte 2000mm aansluiting F 2,8 aansluitafstand 7.9mm voor axiaalventilator		
	bestelnr.	692519	fabrikantnr. —
	beschermrooster L 120mm B 120mm kunststof		

¹met kogellager

koelventilatoren

koelmotoren universeel

toebehoren

ventilatorbladen

aluminium



1

bestelnr.	601571	fabrikantnr.	AF83VENCOND
omschrijving	ventilatorblad drukkend ø 230mm ventilatorblad bevestiging 25.4mm vleugelhoek 28° B 43mm aluminium		

koelventilatoren (compleet)

ebm-papst

serie A4E

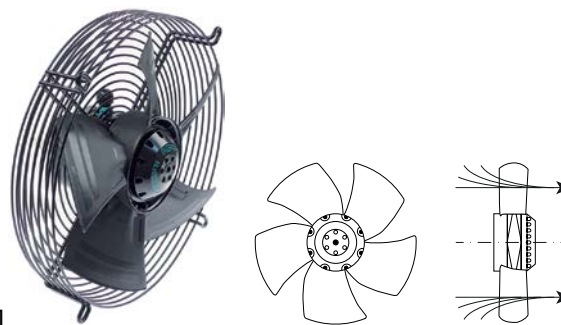

1

bestelnr.	602049	fabrikantnr.	VENTBA5T
omschrijving	ventilator A4E300-AS72-06 ventilatorblad ø 300mm messen 5 230V 50/60Hz 72/90W ø 340mm bevestigingsafstand 265mm 1320/1500U/min kabellengtemm ebm-papst		

dwaarsstroomventilatoren

COPREL

met vergoten spoel



1

bestelnr.	602104	fabrikantnr.	N/A
omschrijving	dwaarsstroomventilator COPREL FFL rol ø 60mm wals L 240mm gelamineerde kerndikte 20mm motorpositie links 230V/50-60Hz 26W universeel lager silicone aansluiting kabel 500mm vermogen 149m ³ /h -10 tot +50°C		

scharnieren

veerscharnieren

universeel

INTERKLIMAT

scharnieren



1

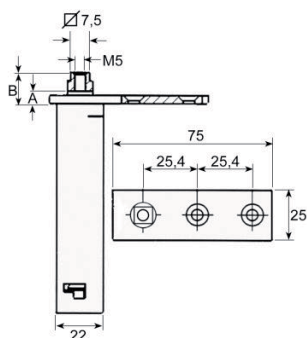

bestelnr.	690622	fabrikantnr.	AF07CERN AF07CERN 10 AFCERN1400
omschrijving	veerscharnier serie 28L inbouwpositie links/rechts L 75mm B 25mm H 103mm A 13mm B 18mm inbouwmaat 22x22mm opname 7,5x7,5 koelapparaat		

toebehoren

diversen



1

bestelnr.	701619	fabrikantnr.	TZXXA056SX
omschrijving	houder voor scharnier L 120mm		

roosters en stelrails

roosters

universeel

zonder afkanting



1

bestelnr.	970896	fabrikantnr.	GRPL600
omschrijving	draadrooster B 530mm D 550mm H 10mm staal kunststof gecoat draadsterkte buitenring 8mm draadsterkte lengted- raden 3mm dwarsbalken 2 grijs		

stelgeleiderails en dragers

fabrikantspecifiek



1

bestelnr.	701483	fabrikantnr.	GL700
omschrijving	geleiderail per paar L-vorm L 650mm B 24mm H 28mm inbouwpositie links/rechts		



1

bestelnr.	692619	fabrikantnr.	GC700
omschrijving	geleiderail per paar U-vorm L 650mm B 14mm H 28mm inbouwpositie links/rechts		



rubbers

koeldeurrubbers

insteekprofielen

Profiel 9048

We kunnen voor dit profiel rubbers op maat produceren

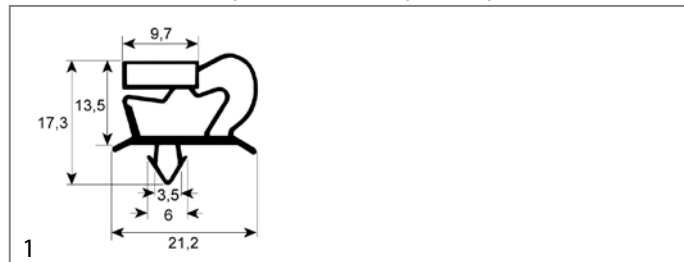

bestelnr.	900944	fabrikantnr.	GC3CTGN
omschrijving	koeldeurrubber profiel 9048 B 387mm L 177mm steekmaat		

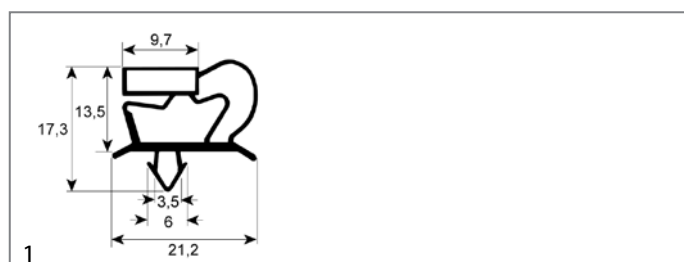

bestelnr.	900945	fabrikantnr.	GC2CTGN
omschrijving	koeldeurrubber profiel 9048 B 387mm L 292mm steekmaat		

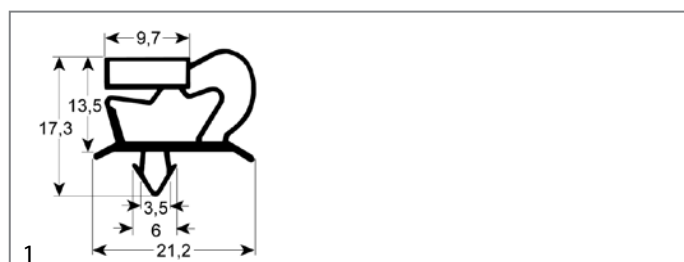

bestelnr.	902063	fabrikantnr.	GPTGN
omschrijving	koeldeurrubber profiel 9048 B 387mm L 633mm steekmaat		

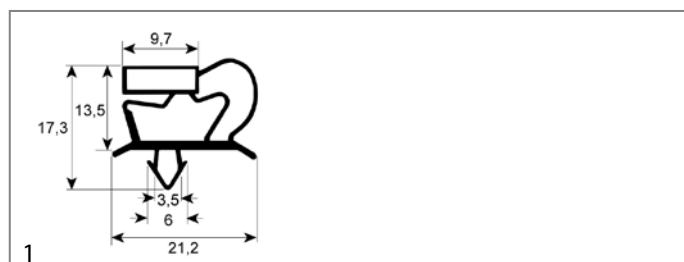

bestelnr.	900947	fabrikantnr.	GPTPA
omschrijving	koeldeurrubber profiel 9048 B 455mm L 635mm steekmaat		

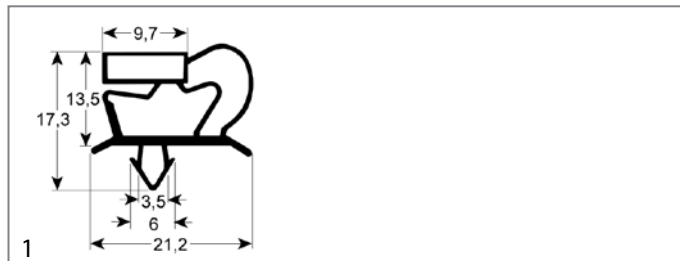

bestelnr.	902110	fabrikantnr.	GPA400
omschrijving	koeldeurrubber profiel 9048 B 540mm L 1390mm steekmaat		

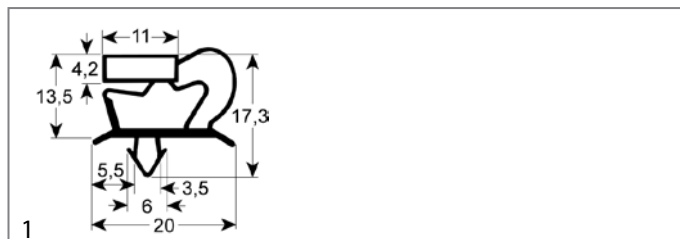

bestelnr.	902467	fabrikantnr.	GSA
omschrijving	koeldeurrubber profiel 9048 B 621mm L 742mm steekmaat		

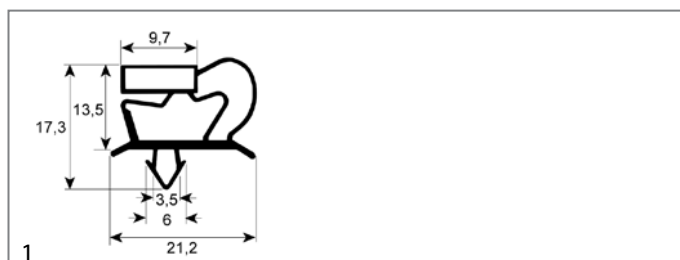

bestelnr.	900949	fabrikantnr.	AF07-013 AF09GUAPO AF14EKOMBT GPA GPA Pos. 13
omschrijving	koeldeurrubber profiel 9048 B 627mm L 1545mm steekmaat		

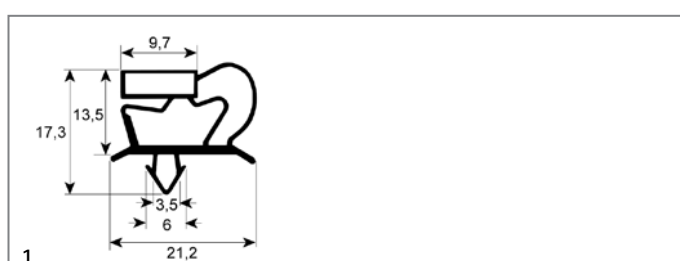

bestelnr.	900948	fabrikantnr.	AF08GUASP AF09GUASP
omschrijving	koeldeurrubber profiel 9048 B 637mm L 742mm steekmaat		

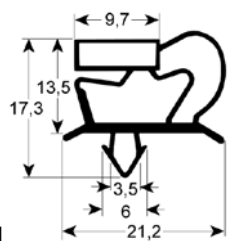

bestelnr.	902258	fabrikantnr.	N/A
------------------	--------	---------------------	-----

omschrijving	koeldeurrubber profiel 9048 Bmm L 2500mm		
---------------------	--	--	--

thermische pakkingen

deurrubbers

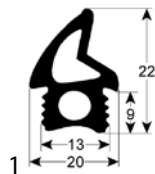

bestelnr.	902483	fabrikantnr.	FO4NEA0039
------------------	--------	---------------------	------------

omschrijving	deurrubber profiel 2763 L 1800mm passend voor TECNODOM		
---------------------	--	--	--

A

axiaalventilatoren 5

C

compressoren 4

D

deurrubbers 8

dwarsstroomventilatoren 5

E

elementen voor koeltechniek 3

I

insteekprofielen 7

insteekvoeler 3

K

koeldeurrubbers 7

koelmotoren universeel 5

koelventilatoren 5

koelventilatoren (compleet) 5

O

ontdooielementen 3

ontdooiwaterverwarming 3

R

roosters 6

roosters en stelrails 6

T

temperatuurvoelers 3

thermische pakkingen 8

thermostaten 3

U

universele voelers 3

V

veerscharnieren 6

ventilatoren 5

verwarmingselementen 3

verwarmingkabels 3

voelers 3