



COMPONENTES GAS



COMPONENTES ELÉCTRICOS



TECNOLOGÍA DEL AGUA



COMPONENTES MECÁNICOS



HERRAMIENTAS

Repuestos adaptables a

TURBOCHEF

Encuentre nuestra gama siempre actualizada en la tienda online de GEV



Catálogo de fabricantes

Las piezas de repuesto y accesorios más importantes de cada fabricante reunidas y ordenadas de manera práctica

- ✓ En la tienda online GEV encontrará el surtido completo y toda la información actualizada de máquinas y aparatos
- ✓ Índice alfabético al final del catálogo

Tienda online GEV

www.gev-online.es
www.gev-online.com



- 🔍 marcar artículos como favoritos
- 🔍 acceso mediante su e-mail y su contraseña habitual
- 🔍 ponga en la cesta de la compra, múltiples artículos a la vez
- 🔍 búsqueda de artículos inmediata sin necesidad conectarse

resistencias

resistencia de microondas



código	418738	referencia	HHB-3202 HHB-3216 HHB-8099 HHB-8201
descripción	resistencia 2500W 208V espirales 1 L 450mm An 170mm rosca 1/4" distancia de sujeción 162mm tubo ø 8mm resistencia seca sujeción 2 orificios longitud de empalme 60mm con kit fijación UE 2 pzs		
Para modelos:	HHB, HHB2		



código	418717	referencia	100649 NGC-3003 NGC-3086
descripción	resistencia 3000W 208V espirales 1 L 395mm An 395mm B2 305mm tubo ø 11mm longitud del cable 200mm B1 45mm brida ø 25mm montaje ø 19mm apto para TURBOCHEF NGC		
Para modelos:	NGC		

unidades de calentamiento



código	418712	referencia	100661 NGC-3011
descripción	unidad calefactora 3300W 208V espirales 1 L 320mm An 147mm H 30mm empalme M5 resistencia circulación de aire agujero ø 6.5mm apto para TURBOCHEF NGC		
Para modelos:	NGC		
repuestos para	418712		
	código	referencia	691396 NGC-1043
	junta L 320mm An 145mm para resistencia		



código	418715	referencia	100652-1
descripción	resistencia 4800W 240V espirales 1 L 250mm An 180mm H 53mm tubo ø 11mm rosca 5/8" UNF longitud del cable 160mm aire caliente H1 7mm H2 46mm distancia de sujeción 170mm apto para Turbochef		
Para modelos:	C3, C3AB, C3C, C3C-MULTI, C3D, C3-MULTI		

resistencias circulación de aire



código	418758	referencia	i5-3216 I5-9317
descripción	resistencia 3000+3000W 208V L 330mm An 170mm tubo ø 8mm kit de servicio		



código	418971	referencia	i3-9378
descripción	resistencia 3000W 208V espirales 1 L 255mm An 75mm longitud brida 65mm anchura brida 19mm		

accesorios

juntas para bridas



código	691433	referencia	C0342 TC3-0194
descripción	junta L 290mm An 230mm para resistencia		
Para modelos:	C3, C3AB, C3C, C3C-MULTI, C3D, C3-MULTI		



código	691396	referencia	NGC-1043
descripción	junta L 320mm An 145mm para resistencia		
Para modelos:	NGC		



código	418716	referencia	NGC-3012
descripción	aislamiento para resistencia		
Para modelos:	NGC		



termostatos

termostatos de superficie

termostatos de superficie



1

código	390615	referencia	102085 102086
descripción	termostato de contacto dist. del agujero 23.5mm temp. desconexión°C 1NO 16A empalme F6,3 temperatura de conexión 48.9°C para ventilador axial		
Para modelos:	C3, C3AB, C3C, C3C-MULTI, C3D, C3-MULTI, HHB, HHB2, HHC2020, HHC3240, i3, i5, NGC, NGO		



1

código	390614	referencia	102070
descripción	termostato de contacto dist. del agujero 40mm temp. desconexión 100°C 1NC 16A empalme F6,3 para Magnetron apto para TURBOCHEF C3		
Para modelos:	C3, C3AB, C3C, C3C-MULTI, C3D, C3-MULTI, i5, NGC		

termostatos de control y seguridad

EGO

termostatos de seguridad

serie 55.33_



1

código	375882	referencia	102075
descripción	termostato de seguridad temp. desconexión 300°C 3 polos 20A sonda ø 4mm sonda L 157mm capilar 520mm aislamiento del capilarmm prensaestopas bulbo inox		

serie 56_



1

código	375883	referencia	7603 R7603
descripción	termostato de seguridad temp. desconexión 350°C 1 polos 16A sonda ø 3.03mm sonda L 138mm capilar 1760mm aislamiento del capilar 1710mm prensaestopas bulbo inox		
Para modelos:	C3, C3AB, C3C, C3C-MULTI, C3-MULTI		

interruptores y pulsadores

microinterruptores

accionado por palanca



1

código	347010	referencia	102012
descripción	microinterruptor con manilla 250V 16A 1CO empalme conector Faston 4,8mm L 36mm temperatura ambiente máx. 105°C distancia de sujeción 22mm tipo D3V-16G443-1C25-K fuerza de accionamiento: 50g longitud de palanca 28mm		
Para modelos:	C3D, HHB2, i3, i5, NGC, NGO		



1

código	347201	referencia	102013 i1-3207
descripción	microinterruptor con manilla 250V 16A 1CO empalme conector Faston 4,8mm L 37mm temperatura ambiente máx. 105°C distancia de sujeción 22mm tipo D3V-16G443-1C25-K fuerza de accionamiento: 70g longitud de palanca 27mm		
Para modelos:	NGO		

accesorios



1

código	691389	referencia	NGC-1126
descripción	contrasoporte para microinterruptor L 44mm An 13mm		
Para modelos:	NGC		

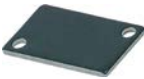
			
1			
código	691391	referencia	NGC-1194
descripción	placa de retención para microinterruptor L 28mm An 16mm		
Para modelos:	NGC		

interruptores magnéticos

29x19mm

			
1			
código	347005	referencia	HHB-3209
descripción	interruptor magnético L 29mm An 19mm 1NO		
Para modelos:	HHB		

accesorios

imanes

			
1			
código	345700	referencia	102789
descripción	imán ømm L 29mm H 6.5mm An 19mm dist. del agujero 16mm M3 agujero ø 3.5mm		
Para modelos:	HHB		



señalizadores de alarma

dispositivos de alarma

			
1			
código	350139	referencia	NGC-3083
descripción	señalizador de alarma ø 31.75mm H 9.5mm sujeción 2 orificios 80dB protección IP54		
Para modelos:	C3, C3D, HHB, HHB2, NGC		

semiconductores de potencia

CRYDOM

			
1			
código	400780	referencia	101285 TC3-3221
descripción	semiconductor de potencia CRYDOM fases 1 carga 50A carga 240V 3-32VDC L 59mm An 46mm Kit atornillado tipo D2450		
Para modelos:	C3, C3AB, C3C, C3C-MULTI, C3-MULTI		
repuestos para	400780		
		código	400781 referencia —
		descripción	semiconductor de potencia CRYDOM fases 1 carga 50A carga 24-280V 3-32VDC L 59mm An 46mm atornillado tipo D2450
		código	401676 referencia —
		descripción	lámina térmica L 57mm An 45mm

			
1			
código	400559	referencia	101284 NGC-3005
descripción	semiconductor de potencia CRYDOM fases 2 carga 40A carga 120-240V 24VDC L 59mm An 46mm conexión enchufable tipo D2440DE-6816		
Para modelos:	C3, C3D, HHB, HHB2, HHC2020, i3, i5, NGC, NGO		

accesorios

diodos

diodos de alta tensión

			
1			
código	379654	referencia	100480 100481
descripción	diodo de alta tensión tipo HV07-16 empalme F6,3 longitud del cable mm apto para TURBOCHEF NGC		
Para modelos:	C3, C3AB, C3C, C3C-MULTI, C3D, C3-MULTI, i3, i5, NGC, NGO		



relés

relés de potencia

con sujeción riel DIN

arriba



1

código	380884	referencia	101279
descripción	relé de potencia MAGNECRAFT 24VDC NO 30A/NC 3A 2CO empalme conector Faston 6,3mm medidas 34x52mm N° fabricante W92S11D22D-24 277V		
Para modelos:	HHC2020		

con lengüeta de sujeción



1

código	380806	referencia	101274
descripción	relé de potencia 24VDC 20A		
Para modelos:	HHC3240, i3, i5, NGC, NGO		
accesorios para	380806		
	código	380805	referencia
			—
	estribo de retención		



1

código	380861	referencia	101271 101273
descripción	relé de potencia MAGNECRAFT 24VDC 16A 2CO empalme conector Faston 6,3mm medida reticular 22.2mm lengüeta de sujeción a 250 V 15A N° fabricante 389CX-179 24VDC		
Para modelos:	C3D, HHB, HHB2, i3, i5, NGC, NGO		



1

código	380860	referencia	101272
descripción	relé de potencia MAGNECRAFT 24VDC 16A 3CO empalme conector Faston 6,3mm medida reticular 11.1mm lengüeta de sujeción a 250 V 15A N° fabricante 389CX-178 24VDC		
Para modelos:	i3, i5, NGC, NGO		

relés enchufables/para circuito impreso



1

código	380862	referencia	T0278
descripción	relé enchufable 2CO		
Para modelos:	C3, C3AB, C3C, C3C-MULTI, C3-MULTI		

portarelés



1

código	380863	referencia	T0309
descripción	zócalo de relé		
Para modelos:	C3, C3AB, C3C, C3C-MULTI, C3-MULTI		



magnetrones



1

código	402048	referencia	100860 TC3-3233
descripción	Magnetron HITACHI tipo 2M121A apto para TURBOCHEF C3		
Para modelos:	C3, C3AB, C3C, C3C-MULTI, C3D, C3-MULTI		
accesorios para	402048		
	código	390614	referencia 102070
	termostato de contacto dist. del agujero 40mm temp. desconexión 100°C 1NC 16A empalme F6,3 para Magnetron apto para TURBOCHEF C3		



1

código	402053	referencia	100861
descripción	Magnetron LG tipo apto para TURBOCHEF NGC		



1

código	403321	referencia	NGC-3015
descripción	Magnetron TOSHIBA tipo 2M248J(FD) apto para TURBOCHEF NGC		
Para modelos:	i3, i5, NGC, NGO		

transformadores

transformadores de alta tensión



1

código	402050	referencia	102104 NGC-3061-2
descripción	transformador		
Para modelos:	i3, i5, NGC, NGO		



1

código	401989	referencia	102093 102093-1 TC3-3223
descripción	transformador de alta tensión		
Para modelos:	C3, C3AB, C3C, C3C-MULTI, C3D, C3-MULTI		

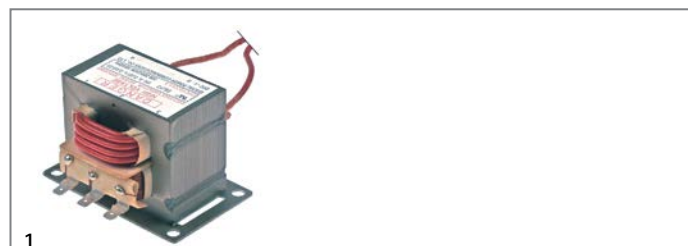

1

código	401987	referencia	102091 102091-1 TC3-3222
descripción	transformador de alta tensión primaria 200-208/240VV 50/60Hz para microondas		
Para modelos:	C3, C3AB, C3C, C3C-MULTI, C3D, C3-MULTI		



1

código	401998	referencia	102103 DPC102103 NGC-3062-2
descripción	transformador de alta tensión primaria 230V secundaria 2000KV empalme conector Faston 50Hz tipo DPC102103 para microondas		
Para modelos:	i3, i5, NGC, NGO		



sensores

sensores específicos del fabricante

sensores



código	379643	referencia	HHC-6517
descripción	sensor Pt100 cable fibra de vidrio sonda -200 a +600°C cable -50 a +350°C empalme conector rosca bulbo ø5x150mm longitud de cable 0.3m		
Para modelos:	HHC3240, i3, i5		



código	379642	referencia	HHC-6517-2
descripción	sensor Pt100 cable fibra de vidrio sonda -200 a +600°C cable -50 a +350°C empalme conector rosca bulbo ø5x50mm longitud de cable 0.3m		
Para modelos:	HHC2020, NGO		



código	379897	referencia	HHB-8170 NGC-1140
descripción	termopar termopar J (Fe-CuNi) cable PTFE sonda -50 a +750°C cable -40 a +250°C empalme de dos hilos rosca bulbo ø1,5x155mm longitud de cable 1m		
Para modelos:	HHB, HHB2, NGC		

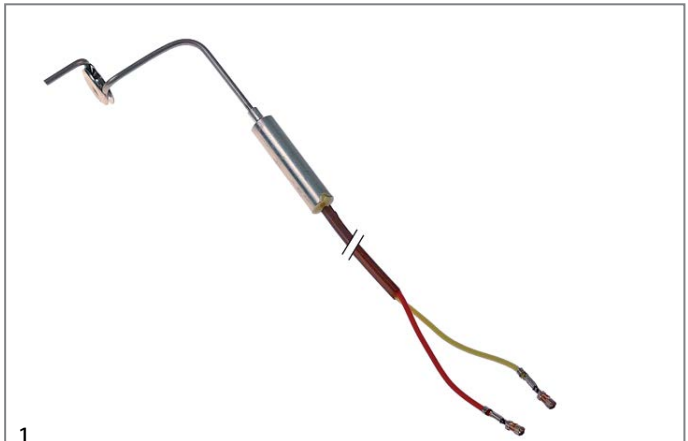

código	379895	referencia	HHB-8170 NGC-1140
descripción	termopar termopar K (NiCr-Ni) cable PTFE sonda -50 a 1150°C cable -40 a +250°C empalme de dos hilos rosca		

código	379894	referencia	102065
descripción	termopar termopar K (NiCr-Ni) cable PTFE sonda -50 a 1150°C cable -40 a +250°C empalme de dos hilos rosca bulbo ø1,5x155mm longitud de cable 1m		
Para modelos:	C3, C3AB, C3C, C3C-MULTI, C3D, C3-MULTI		

código	379896	referencia	700-1199
descripción	termopar termopar K (NiCr-Ni) cable PTFE sonda -50 a 1150°C cable -40 a +250°C empalme de dos hilos rosca bulbo ø2,5x10mm longitud de cable 0.1m		
Para modelos:	C3, C3D, HHB, HHB2, i5, NGC		

accesorios

uniones roscadas



código	691450	referencia	102718
descripción	unión roscada rosca 1/16 x 1/8NPT		



electrónicas

EPROMs



1

código	401999	referencia	NGC-1099-17 NGC-3027-1
descripción	EPROM apto para DUNKIN DONUTS CODE 39F9B5 15.03.07		



1

código	401979	referencia	NGC-1099-4
descripción	EPROM apto para TURBOCHEF NGC CODE 3C8F89 11.05.05		



1

código	401978	referencia	NGC-1099-9
descripción	EPROM SUBWAY apto para TURBOCHEF NGC CODE 3C0173		

placas electrónicas



1

código	401984	referencia	101211 NGC-3069
descripción	alimentador con carcasa		
Para modelos:	C3D, HHB, HHB2, HHC2020, HHC3240, i3, i5, NGC, NGO		



1

código	401990	referencia	101206 NGC-3069 (old version)
descripción	alimentador entrada 100-240VACV salida 24VDCV		
Para modelos:	HHB		



1

código	401995	referencia	HHB-3204 HHB-8131
descripción	display		



1

código	401996	referencia	T0238 TC3-3229
descripción	display apto para TURBOCHEF C3 completo con control		



1

código	401997	referencia	T0238 TC3-3229	
descripción	display apto para TURBOCHEF C3 completo con control			
Para modelos:	C3, C3AB, C3C, C3C-MULTI, C3D, C3-MULTI			
repuestos para	401997			
	código	401971	referencia	NGC-1110-1
	teclado de membrana apto para Turbochef L 295mm An 100mm			
	código	401996	referencia	T0238 TC3-3229
	display apto para TURBOCHEF C3 completo con control			



1

código	402229	referencia	100505 HHB-3204 HHB-8131
descripción	display apto para TURBOCHEF HHC2020 completo con control		
Para modelos:	HHB, HHB2, HHC2020, HHC3240		



1

código	401901	referencia	HHB-3213-1
descripción	placa de control		



1

imagen no disponible

código	401910	referencia	100505 HHB-3204 HHB-8131 TC3-3229
descripción	display apto para Turbochef modelo 3240/2020 VFD		





1

código	401973	referencia	CON-3007-4-1 NGC-3026-4 NGC-3044-1
descripción	placa de control		



1

código	401991	referencia	HHB-3204 NGC-3023
descripción	display apto para TURBOCHEF NGC con cable		
Para modelos:	HHC2020, NGC		
repuestos para	401991		
	código	401680	referencia
			100184 NGC-1530
	cable de cinta plana 26 polos L 290mm tipo de conector FC-26P medida reticular 2.54mm		



1

código	403864	referencia	CON-3008-1-1
descripción	placa de control L 185mm An 115mm		



1

código	403883	referencia	CON-3009-2-25
descripción	placa de control L 185mm An 115mm países Europa menú Smart		

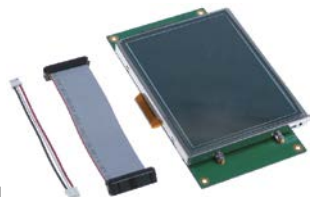

1

código	402177	referencia	103360 CON-7004 i5-3207
descripción	display L 130mm An 105mm apto para TURBOCHEF i5 kit de servicio		
Para modelos:	i3, i5		



1

código	402132	referencia	NGC-1054-2
descripción	placa de control microondas aire caliente TURBOCHEF NGC completo		
Para modelos:	NGC		

1

código	401988	referencia	C0265 TC3-3213-0294
descripción	placa de control países Europa menú Smart		



1

código	402102	referencia	NGC-1008 NGC-3049-7
descripción	placa electrónica apto para TURBOCHEF NGC países (Europe,Asia,Pacific) con „BLANK SMART CARD“ Service Kit I/O PCB Subway		
Para modelos:	HHB		



1

código	401704	referencia	CON-3007-11-3 NGC-3055-3
descripción	placa de control STARBUCKS		



1

código	403051	referencia	CON-3007-8-7
descripción	placa electrónica microondas Turbochef NGC, SAGE 2, SUBWAY países (Europe,Asia,Pacific) con „BLANK SMART CARD“ Service Kit I/O PCB Subway		



1

código	401985	referencia	M9608
descripción	placa de potencia TURBOCHEF C3 aliment. 115-230V salida 24VDCV		
Para modelos:	C3, C3AB, C3C, C3C-MULTI, C3-MULTI		



1

código	403601	referencia	CON-7013
descripción	placa electrónica NGC-HHB-C3D-2020		
Para modelos:	C3, C3D, HHB, HHB2, HHC2020, NGC		



1

código	402299	referencia	100446 CON-7039
descripción	placa electrónica		
Para modelos:	i3, i5, NGO		



1

código	401886	referencia	100446 CON-7039
descripción	placa electrónica NGO-i3-i5		



1

código	402178	referencia	CON-3001 CON-3001-1-1 CON-3001-XXXX i5-3208-1
descripción	placa electrónica TURBOCHEF i3-i5 L 190mm An 115mm kit de servicio		
Para modelos:	i3, i5		

unidades centrales



1

código	401993	referencia	100431 TC3-3234-1
descripción	caja de menú		

teclados

teclados de membrana



1

código	401971	referencia	NGC-1110-1
descripción	teclado de membrana apto para Turbochef L 295mm An 100mm		
Para modelos:	NGC		



1

código	401972	referencia	NGC-1110-2
descripción	teclado de membrana apto para TURBOCHEF SUBWAY L 295mm An 100mm		
Para modelos:	NGC		



1

código	402180	referencia	HHC-1234
descripción	teclado de membrana para horno tazas 11 L 203mm An 74mm		
Para modelos:	HHC2020, HHC3240		



1

código	402227	referencia	i3-9247
descripción	teclado de membrana para i3 L 515mm An 85mm		



1

código	401907	referencia	NGC-1110-3
descripción	teclado de membrana STARBUCKS apto para Turbochef L 295mm An 98mm		
Para modelos:	NGC		



1

código	402179	referencia	i5-9247
descripción	teclado de membrana tazas 26 apto para TURBOCHEF i5 L 634mm An 85mm		
Para modelos:	i5		

accesorios



1			
código	691406	referencia	NGC-1040
descripción	panel frontal apto para TURBOCHEF NGC		
Para modelos:	NGC		

ventiladores

ventilador axial

importación



1			
código	601460 ¹	referencia	TC3-3210
descripción	ventilador axial L 119mm An 119mm H 25mm 230VAC 50/60Hz 14/16W cojinete rodamiento de bolas empalme conector Faston 6,3mm kit de modificación ORION apto para TURBOCHEF C3 rodete ventilador ø 110mm resis.a la temp. 80°C		
Para modelos:	C3		
repuestos para	601460		
	código	referencia	—
	601131		
	ventilador axial L 119mm An 119mm H 25mm 230VAC 50/60Hz 19/18W cojinete rodamiento de bolas empalme conector Faston 2,8mm metal ADDA rodete ventilador ø 110mm resis.a la temp. 70°C		

¹con rodamiento de bolas



1			
código	601080 ¹	referencia	100516
descripción	ventilador axial L 119mm An 119mm H 38mm 230VAC 50/60Hz 23/20W cojinete rodamiento de bolas empalme conector Faston 2,8mm metal ADDA rodete ventilador ø 110mm resis.a la temp. 70°C		
Para modelos:	HHB, HHB2, NGO		
accesorios para	601080		
	código	referencia	—
	550898		
	cable de conexión longitud del cable 2000mm empalme F 2,8 distancia de empalme 7.9mm para ventilador axial		
	código	referencia	—
	692519		
	rejilla de protección L 120mm An 120mm plástico		

¹con rodamiento de bolas

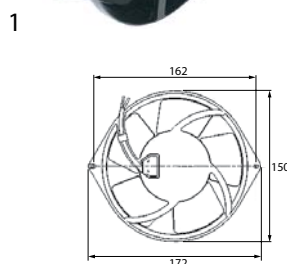

código	601469 ¹	referencia	100085
descripción	ventilador axial L 172mm An 150mm H 55mm 230VAC 50/60Hz 42W cojinete rodamiento de bolas empalme cable metal ORION rodete ventilador ø 140mm resis.a la temp. 70°C		
Para modelos:	C3		

¹con rodamiento de bolas

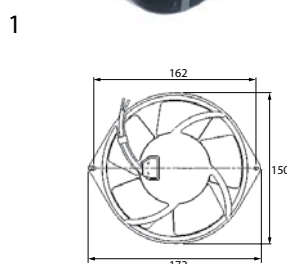

código	601500 ¹	referencia	TC3-0433
descripción	ventilador axial L 172mm An 150mm H 55mm 230VAC 50/60Hz 42W cojinete rodamiento de bolas empalme cable metal ORION rodete ventilador ø 145mm resis.a la temp. 70°C		
Para modelos:	C3D, HHC2020, i3, i5		

¹con rodamiento de bolas



motores de aire caliente

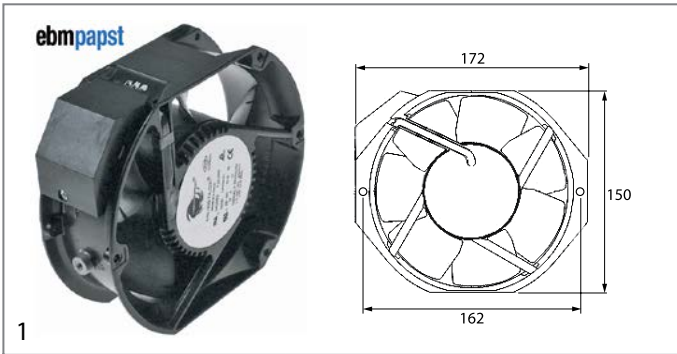

código	601459	referencia	100518 NGC-3077
descripción	ventilador axial L 172mm An 150mm H 55mm 230VAC 50/60Hz		

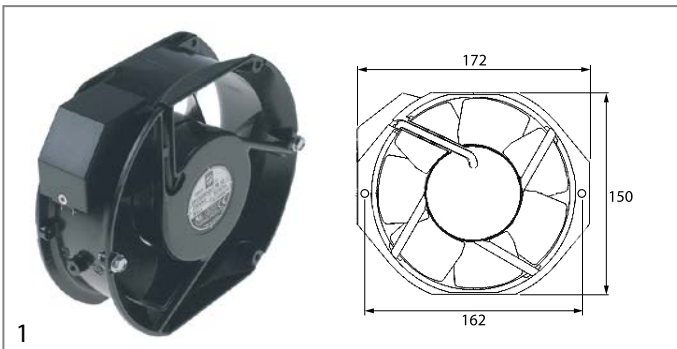

código	601473 ¹	referencia	100518 100574 NGC-3077
descripción	ventilador axial L 172mm An 150mm H 55mm 230VAC 50/60Hz 35W cojinete rodamiento de bolas empalme conector Faston 2,8mm metal ORION apto para Turbochef rodete ventilador ø 140mm resis.a la temp. 70°C		
Para modelos:	NGC		

¹con rodamiento de bolas

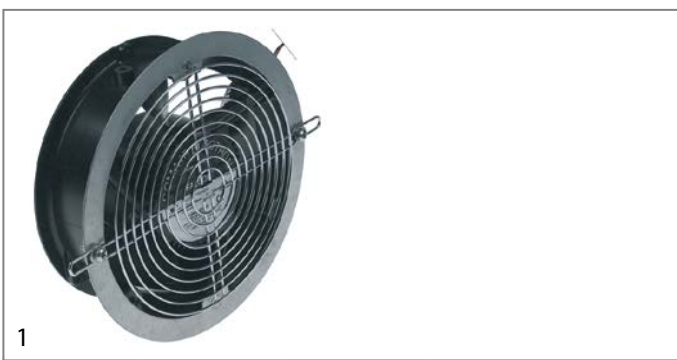

código	601468 ¹	referencia	100519 100519-1 M9609 TC3-3202
descripción	ventilador axial D1 ø 172mm D2 ø 195mm H 55mm 24VDC 50W cojinete rodamiento de bolas N° fabricante FDD24Z3A2 empalme cable 300mm longitud del cable 300mm con rejilla de protección FALCON apto para Turbochef rodete ventilador ø 155mm redondo		
Para modelos:	C3, C3AB, C3C, C3C-MULTI, C3-MULTI		

¹con rodamiento de bolas

código	601466	referencia	700-0306-2
descripción	brida para motor de ventilador ø ext. 44.5mm ø int. 2 16mm espesor 6.5mm acero		
Para modelos:	C3, C3AB, C3D, C3-MULTI		

código	601461	referencia	NGC-1019-2 NGC-1020 NGC-3007
descripción	rodete ventilador D1 ø 160mm H1 40mm palas 12 D2 ø 16mm D3 ø 16mm H2 16mm		
Para modelos:	NGC		
repuestos para	601461	código	601466
		referencia	700-0306-2





ventiladores de aire caliente

otros

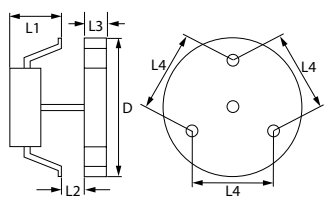

1



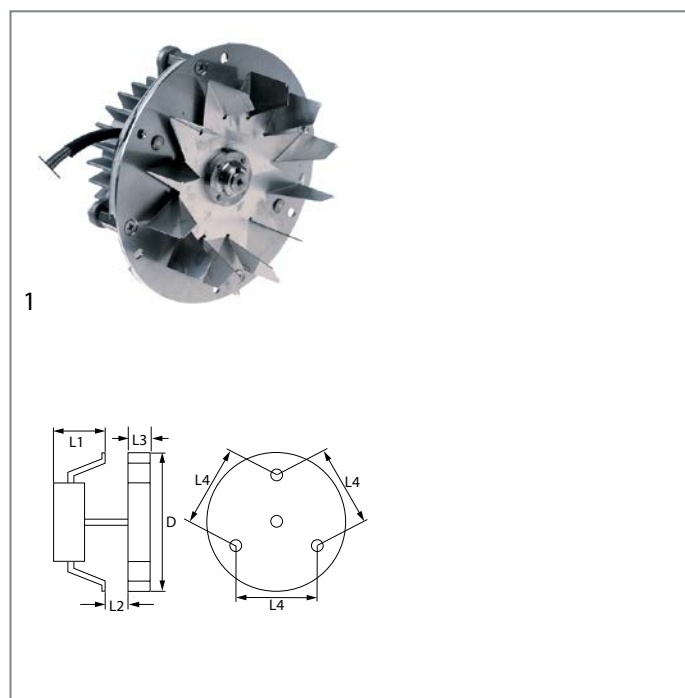

código	601462	referencia	100882 NGC-1025
descripción	ventilador de aire caliente 180V L1 91mm L2 5mm L3 40mm L4 95mm rodete ventilador ø 180mm Aspen tipo M34-0030 2A		
Para modelos:	NGC		
repuestos para	601462		
	código	601461	referencia NGC-1019-2 NGC-1020 NGC-3007
	rodete ventilador D1 ø 160mm H1 40mm palas 12 D2 ø 16mm D3 ø 16mm H2 16mm		

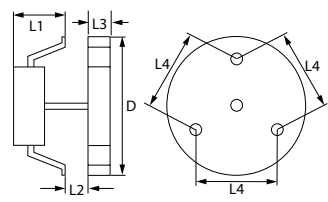

1



código	601465	referencia	HHB-8106 TC3-0213
descripción	ventilador de aire caliente 180V L1 91mm L2 5mm L3 45mm L4 95mm rodete ventilador ø 170mm Aspen tipo M34-0030 2A		
Para modelos:	C3, C3D, HHB, HHB2		
repuestos para	601465		
	código	601466	referencia 700-0306-2
	brida para motor de ventilador ø ext. 44.5mm ø int. 2 16mm espesor 6.5mm acero		
	código	691380	referencia 605-0070
	anillo ø 170mm para rodete de ventilador		

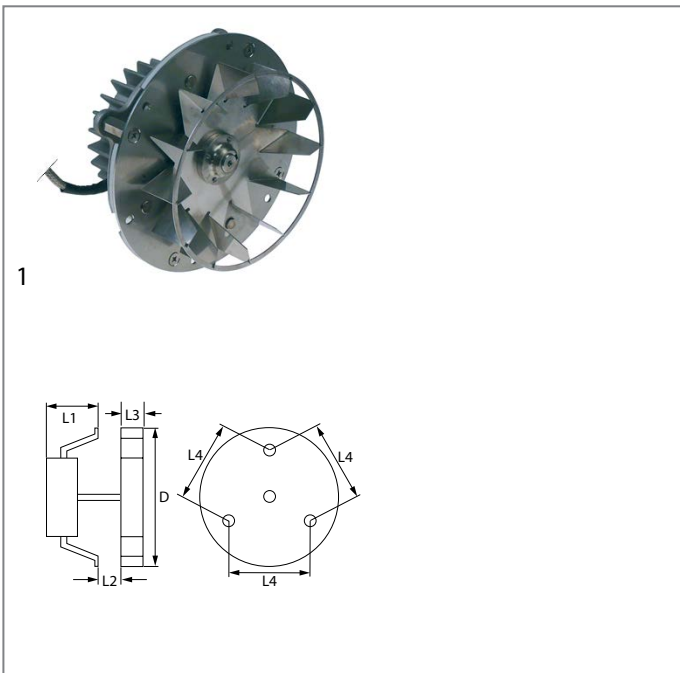

código	601471	referencia	C0299 T0076 T0299 TC3-3201
descripción	ventilador de aire caliente 180V L1 91mm L2 7mm L3 43mm L4 95mm rodete ventilador ø 160mm Aspen tipo M34-0030 con platina e instrucciones de servicio 2A		
Para modelos:	C3, C3AB, C3C, C3C-MULTI, C3-MULTI		
repuestos para	601471		
	código	403601	referencia CON-7013
	placa electrónica NGC-HHB-C3D-2020		



código	601675	referencia	103551 i3-3209-2 i3-3209-4 i3-9042
descripción	motor de ventilador 180Vc.a. 1.4A pos. de montaje abajo rodete ventilador ø 97mm		
Para modelos:	i5		



código	601676	referencia	i3-3209-1 i3-3209-3 i3-9040 i3-9040.B
descripción	motor de ventilador 180Vc.a. 1.4A pos. de montaje arriba L1 90mm L2mm L3mm L4 100mm rodete ventilador ø 97mm tipo RM34-0111		



código	601660	referencia	i5-3218-2 i5-3218-4 i5-9042 i5-9221
descripción	motor de ventilador 180Vc.a. 250W 1.4A pos. de montaje abajo L1 88mm L2 18mm L3 52mm L4 100mm rodete ventilador ø 97mm para i5		
Para modelos:	i5		





código	601661	referencia	i5-3218-1 i5-3218-3 i5-9040 i5-9220
descripción	motor de ventilador 180Vc.a. 250W 1.4A pos. de montaje arriba L1 88mm L2 18mm L3 52mm L4 100mm rodete ventilador ø 97mm		
Para modelos:	i5		

accesorios

rodetes de ventilador para ventiladores de aire caliente



código	691432	referencia	605-0069
descripción	rodete ventilador ø 170mm An 42.5mm soporte de eje ø 25mm palas 12		
Para modelos:	C3, C3AB, C3C, C3C-MULTI, C3D, C3-MULTI		
accesorios para	691432		
	código	601466	referencia 700-0306-2
	descripción	brida para motor de ventilador ø ext. 44.5mm ø int. 2 16mm espesor 6.5mm acero	
	código	691380	referencia 605-0070
	descripción	anillo ø 170mm para rodete de ventilador	

otros

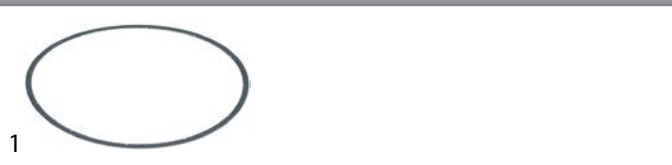

código	691380	referencia	605-0070
descripción	anillo ø 170mm para rodete de ventilador		
Para modelos:	C3, C3AB, C3C, C3C-MULTI, C3D, C3-MULTI		

ventiladores radiales

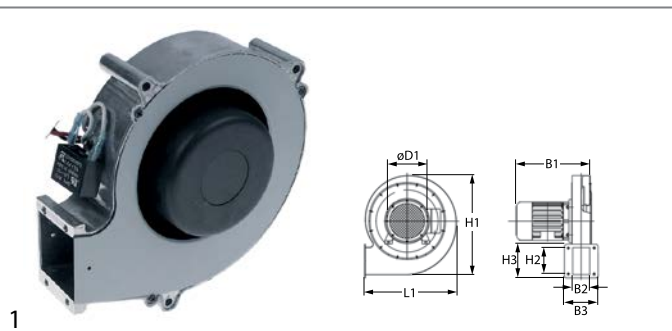

código	601472	referencia	100083
descripción	ventilador radial 230V tensión AC 50/60Hz 65/80W H1 190mm L1 195mm D1 ø 110mm B1 71mm B2 44.5mm H2 47mm B3 49mm H3 68mm		
Para modelos:	C3D, HHC3240, i5, NGC		

otros



código	601464	referencia	T0262
descripción	ventilador radial 24V tensión DC 26W H1 160mm L1 160mm D1 ø 101mm B1 50mm B2 34mm H2 62mm B3 40mm H3 115mm para Magnetron		
Para modelos:	C3, C3AB, C3C, C3C-MULTI, C3-MULTI		

motores

motorreductores

para hornos

para chimeneas



código	601467	referencia	100891
descripción	motorreductor CROUZET tipo 823440 3W 230V 50Hz 6rev/min árbol ø 4mm L 65mm An 51mm H 34mm		
Para modelos:	C3, C3AB, C3C, C3C-MULTI, C3D, C3-MULTI		
accesorios para	601467		

	código	691422	referencia	C0283 T0283
	descripción	rueda dentada para motor apto para TURBOCHEF C3		



código	601470	referencia	HHB-3200 HHB-3231 HHB-8048 HHB-8135
descripción	motorreductor CROUZET tipo 80533004 16.7W 230V 60Hz 3.6rev/min árbol ø 8mm L 87mm An 61mm H 56mm		
Para modelos:	HHB, HHB2		



condensadores y filtros antiparasitarios

filtros

filtros de red

con alojamiento



1

código	365071	referencia	100541 100542 C0980
descripción	filtro de red 15A capacidad 0,004µF		
Para modelos:	C3, C3C-MULTI, C3D, C3-MULTI, HHC3240		



1

código	365112	referencia	100543
descripción	filtro de red 250V 50/60Hz 40A		
Para modelos:	NGC, NGO		



1

código	365075	referencia	100545
descripción	filtro de red 36A		
Para modelos:	NGC		



1

código	365104	referencia	100546
descripción	filtro de red 440V 50/60Hz 50A		
Para modelos:	i3, i5		



1

código	365069	referencia	100539
descripción	filtro de red 6A capacidad 0,055µF		
Para modelos:	HHB, HHB2, HHC2020		

condensadores de alta tensión



1

código	365091 ¹	referencia	100232
descripción	condensador de alta tensión para microondas 0,91 / 0,19µF tipo N64H2511G24A4 2500V 50/60Hz doble empalme conector Faston 6,3mm L 109mm H 46.5mm An 71mm dependiente de aparato aluminio UE 1 pzs		
Para modelos:	i3, i5, NGO		

¹con estribo de fijación

1

código	365068	referencia	100201 NGC-3020
descripción	condensador de alta tensión para microondas 0.91µF tipo N42H-2591G21A4 2500V 50/60Hz triple empalme conector Faston 6,3mm aluminio UE 1 pzs		
Para modelos:	NGC		



1

código	365072 ¹	referencia	100200 100205 100206 TC3-3220
descripción	condensador de alta tensión para microondas 1,05 / 0,15µF tipo HCH-250515P 2500V 50/60Hz doble empalme conector Faston 6,3mm L 108mm H 46mm An 70mm juego de estribos aluminio UE 1 pzs		
Para modelos:	C3, C3AB, C3C, C3C-MULTI, C3D, C3-MULTI		
repuestos para	365072		
	código	365070	referencia TC3-3219
	condensador de alta tensión para microondas 1,05 / 0,15µF tipo HCH-250515P 2500V 50/60Hz doble empalme conector Faston dependiente de aparato aluminio UE 1 pzs		

¹con estribo de fijación

1

código	365070	referencia	TC3-3219
descripción	condensador de alta tensión para microondas 1,05 / 0,15µF tipo HCH-250515P 2500V 50/60Hz doble empalme conector Faston dependiente de aparato aluminio UE 1 pzs		
Para modelos:	C3		



			
1			
código	365074	referencia	100204 NGC-3020-2
descripción	condensador de alta tensión para microondas 1.15µF tipo HCH-252115B 2500V 50/60Hz triple empalme conector Faston 6,3mm dependiente de aparato aluminio UE 1 pzs		
Para modelos:	NGC		

			
1			
código	365073 ¹	referencia	N42H2511G22A4 NGC-3020-2
descripción	condensador de alta tensión para microondas 1.15µF tipo N42H-2511G22A4 2500V 50/60Hz triple empalme conector Faston 6,3mm L 107mm H 40mm An 66mm juego de estribos aluminio UE 1 pzs		

¹con estribo de fijación

fusibles

fusibles finos

			
1			
código	358836	referencia	100592 100596
descripción	fusible fino medida ø10,4x35(38)mm 12A rápido nominal 600V tipo ATMR/KTK-R UE 1 pzs		
Para modelos:	C3, C3AB, C3C, C3C-MULTI, C3D, C3-MULTI, HHB, HHB2, i3, i5, NGC, NGO		

			
1			
código	358837	referencia	100599
descripción	fusible fino medida ø10,4x35(38)mm 20A rápido nominal 600V tipo ATMR/KTK-R UE 1 pzs		
Para modelos:	HHC2020, HHC3240, i3, NGC, NGO		

			
1			
código	358838	referencia	100597
descripción	fusible fino medida ø10,4x35(38)mm 25A rápido nominal 600V tipo ATMR/KTK-R UE 1 pzs		
Para modelos:	C3, C3C		

diversos

			
1			
código	358009	referencia	100593
descripción	fusible tamaño 10,3x38mm 12A nominal 600V UE 1 pzs		
Para modelos:	C3D, i5		

portafusibles

			
1			
código	358835	referencia	100586
descripción	portafusibles fusible adaptable ø6,3x32mm ø 14.5mm 30A nominal 600V empalme F6,3 máx. 30A		
Para modelos:	C3D, HHB, NGC		
accesorios para	358835		
	código	referencia	
	358836	100592 100596	
	fusible fino medida ø10,4x35(38)mm 12A rápido nominal 600V tipo ATMR/KTK-R UE 1 pzs		
	código	referencia	
	358837	100599	
	fusible fino medida ø10,4x35(38)mm 20A rápido nominal 600V tipo ATMR/KTK-R UE 1 pzs		
	código	referencia	
	358838	100597	
	fusible fino medida ø10,4x35(38)mm 25A rápido nominal 600V tipo ATMR/KTK-R UE 1 pzs		

			
1			
código	550983	referencia	100590 T0703
descripción	portafusibles fusible adaptable ø10x38mm 1 polos 30A nominal 600V L 78mm An 18mm H 59mm		
Para modelos:	C3		

contactores de protección de línea

otros

			
1			
código	358236	referencia	103170
descripción	contactador de protección de línea 2 polos corriente de descon. 15A		
Para modelos:	C3, C3C-MULTI, C3-MULTI		



1

código	358235	referencia	103177 T0322
descripción	contactor de protección de línea 3 polos corriente de descon. 35A		
Para modelos:	C3, C3AB, C3C		

accesorios eléctricos

cables

cables de alimentación aparatos



1

código	550978	referencia	100194
descripción	cable de conexión CEE 4 polos 1.9m con conector tipo de conector 30A		
Para modelos:	NGC		



1

código	550979	referencia	HHB-8195-3
descripción	cable de conexión CEE 5 polos 1.9m con conector 16A		
Para modelos:	HHB, HHB2		

cables de cinta plana

grupo 1



1

código	401680	referencia	100184 NGC-1530
descripción	cable de cinta plana 26 polos L 290mm tipo de conector FC-26P medida reticular 2.54mm		
Para modelos:	HHC2020, HHC3240, NGC		

otros



1

código	102444	referencia	103575 HHC-6582-5
descripción	cable para control de llama		
Para modelos:	HHC3240		

cables de enlace



1

código	401980	referencia	100186
descripción	cable de conexión para Magnetron		
Para modelos:	C3D, i3, NGC		



1

código	401681	referencia	100182
descripción	cable de enlace L 150mm 4 polos		
Para modelos:	HHC2020, i3, i5, NGC, NGO		



1

código	401682	referencia	103023
descripción	cable de enlace L 360mm 4 polos		
Para modelos:	HHB, HHC3240		

terminales

bloques de bornes

WIELAND

bloques de bornes tipo 9700A



1

código	550381	referencia	102046 T0704
descripción	borne seccionable WIELAND tipo 9700A/8 S35 1,0-10mm ² riel de sombrero 35mm gris An 8mm L 46.6mm		
Para modelos:	C3		



componentes electrónicos

tarjetas chip

tarjetas chip



código	401705	referencia	i5-3206
descripción	kit de servicio actualización Firmware		



código	402054	referencia	NGC-1181-21
descripción	tarjeta chip Menú apto para DUNKIN DONUTS edición 30.03.07		



código	401982	referencia	100508
descripción	tarjeta chip Smart Card Blank		
Para modelos:	NGC		



código	401981	referencia	NGC-1181-116 NGC-1181-2(D)
descripción	tarjeta chip Smart Card Subway Menú General		

lectores de tarjetas chip



código	401992	referencia	100506
descripción	lector de tarjetas chip		
Para modelos:	C3D, HHB, HHB2, HHC2020, HHC3240, NGC, NGO		

inversor



código	402176	referencia	HHC-3012-2 HHC-6630-2
descripción	inversor para horno aliment. 220/240V 50/60Hz 4.3A 0-240V 0-1500Hz		
Para modelos:	HHC2020, HHC3240		

software

kits de servicio



código	401705	referencia	i5-3206
descripción	kit de servicio actualización Firmware		



código	401975	referencia	NGC-3027-4 NGC-3030-1 NGC-3030-4
descripción	kit de servicio apto para Turbochef estándar with software países (Europe, Asia, Pacific MPH) para ventilador		
Para modelos:	NGC		

accesorios para	401975	código	401999	referencia	NGC-1099-17 NGC-3027-1
EPROM apto para DUNKIN DONUTS CODE 39F9B5 15.03.07					



código	401976	referencia	NGC-3030-6
descripción	kit de servicio apto para Turbochef SWY with software países (Europe, Asia, Pacific MPH) para ventilador		
Para modelos:	NGC		



código	401977	referencia	NGC-3030-9
descripción	kit de servicio apto para Turbochef SWY with software países (Europe, Asia, Pacific MPH) para ventilador		
Para modelos:	NGC		

repuestos para	401977	código	401978	referencia	NGC-1099-9
EPROM SUBWAY apto para TURBOCHEF NGC CODE 3C0173					

otros



código	401696	referencia	Servicekit komplett
descripción	kit de servicio completo apto para Turbochef		





sensores de tensión

			
1			
código	401994	referencia	100783
descripción	sensor de tensión		
Para modelos:	HHB, HHB2, HHC2020, i3, i5, NGC, NGO		

para microondas

eléctrico

microinterruptores

			
1			
código	691439	referencia	NGC-1075 NGC-3033
descripción	microinterruptor Austauschset		
Para modelos:	NGC		
repuestos para	691439		
	código	691401	referencia NGC-1087
	resorte de torsión cierre de puerta		
	código	691421	referencia NGC-1075 NGC-3033
	microinterruptor Kit apto para TURBOCHEF NGC		
accesorios para	691439		
	código	890245	referencia 100639 NGC-3006
	grasa de silicona Turbochef jeringa 20ml		

otros

kits de servicio

			
1			
código	401696	referencia	Servicekit komplett
descripción	kit de servicio completo apto para Turbochef		

encendidos y temopares

cables de encendido

cables prefabricados

			
1			
código	102443	referencia	103574 HHC-6582-3
descripción	cable de encendido longitud del cable 370mm empalme F6,3mm / ø6,5mm UE 1m ø ext. 7mm aislam. silicona		
Para modelos:	HHC3240		

			
1			
código	691588	referencia	TC3-0224
descripción	filtro L 235mm An 180mm TURBOCHEF C3		
Para modelos:	C3AB, C3C, C3C-MULTI, C3-MULTI		

componentes específicos



para hornos a convección/combinados

cajas y paneles frontales

			
1			
código	692165	referencia	NGC-1312
descripción	película de PTFE para horno L 360mm An 320mm		

carcasas

partes interiores

			
1			
código	691443	referencia	NGC-1097 NGC-3004 NGC-3029 NGC-3036
descripción	cubierta para guías apto para TURBOCHEF NGC con sellador		
Para modelos:	NGC		
accesorios para	691443		
	código	890243	referencia 102563 102567
	silicone de alta temperatura PERMATEX HIGH-TEMP RED RTV SILI-CONE 85g T máx 343°C tubo		

cajas y paneles frontales			
1			
código	691383	referencia	100690 NGC-1163
descripción	aislamiento apto para Turbochef		
Para modelos:	C3D, i3, NGC		

1			
código	691460	referencia	NGC-1071 NGC-1071-2
descripción	panel frontal pos. de montaje abajo TURBOCHEF NGC		
Para modelos:	NGC		

placas cerámicas			
1			
código	691409	referencia	NGC-3038
descripción	placa cerámica liso L 377mm An 328mm H 10mm		
Para modelos:	NGC		

1			
código	691469	referencia	700-0302 TC3-3215
descripción	placa cerámica ø 255mm		
Para modelos:	C3AB, C3C, C3C-MULTI, C3-MULTI		

otros			
1			
código	691592	referencia	100011
descripción	cesta de PTFE An 370mm H 345mm fondo perforado espesor 26mm		

1			
código	691456	referencia	NGC-1380
descripción	cesta de PTFE L 345mm An 345mm H 26mm		

1			
código	691594	referencia	101191
descripción	tapón ciego		
Para modelos:	HHB, HHB2, NGC		

puertas			
bisagras para puerta			
1			
código	691512	referencia	102804
descripción	bisagra de puerta pos. de montaje derecho apto para Turbochef NGC, SAGE 2, SUBWAY		
Para modelos:	HHB2, NGC		

1			
código	691440	referencia	102805
descripción	bisagra de puerta pos. de montaje izquierdo apto para Turbochef NGC, SAGE 2, SUBWAY		
Para modelos:	HHB2, NGC		



topes de puerta



1	código	691418	referencia	TC3-0250
	descripción	tope de puerta Kit apto para TURBOCHEF C3		
	Para modelos:	C3		

para hornos

cajas y paneles frontales



1	código	691462	referencia	NGC-1431
	descripción	placa adhesiva de advertencia „DO NOT LIFT OVEN BY DOOR HANDLE” amarillo TURBOCHEF NGC		

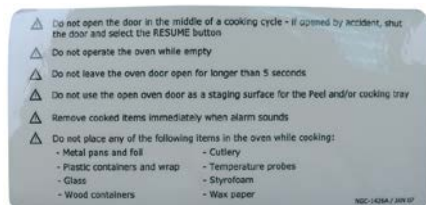

1	código	691463	referencia	NGC-1426
	descripción	placa adhesiva de advertencia blanco TURBOCHEF NGC		

otros



1	código	691464	referencia	NGC-1362
	descripción	instrucciones de limpieza TURBOCHEF NGC		

para hornos de pizza

recambios y accesorios



1	código	691410	referencia	700-0673
	descripción	pala madera		

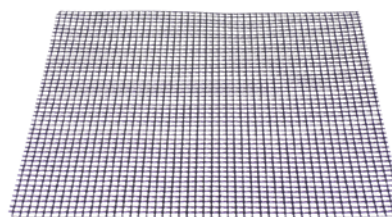

1	código	692429	referencia	100014
	descripción	rejilla de PTFE L 310mm An 310mm		



manillas y volantes

asas de arco

			
1			
código	691430	referencia	102750
descripción	asa de arco L 327mm H 22mm distancia de sujeción 305mm		
Para modelos:	NGC		

			
1			
código	691593	referencia	T0267
descripción	asa de arco L 327mm H 22mm distancia de sujeción 305mm		
Para modelos:	C3, C3AB, C3D, C3-MULTI		

bisagras

bisagras para hornos

			
1			
código	691512	referencia	102804
descripción	bisagra de puerta pos. de montaje derecho apto para Turbochef NGC, SAGE 2, SUBWAY		
Para modelos:	HHB2, NGC		



			
1			
código	691440	referencia	102805
descripción	bisagra de puerta pos. de montaje izquierdo apto para Turbochef NGC, SAGE 2, SUBWAY		
Para modelos:	HHB2, NGC		

			
1			
código	700849	referencia	102807 TUR-102807
descripción	bisagra para horno distancia de sujeción 90mm longitud de palanca 39mm distancia de ranura 11mm espesor de resorte 2.6mm longitud muelle 62mm L 155mm An 22mm izquierdo/derecho TURBOCHEF HHB		
Para modelos:	HHB		

			
1			
código	700747	referencia	HHB-8084
descripción	contrasoporte distancia de sujeción 107mm L 125mm An 19mm para bisagra apto para TURBOCHEF HHB		
Para modelos:	HHB		

soporte de puerta

			
1			
código	691402	referencia	NGC-1076 NGC-1076-2
descripción	bisagra de puerta		
Para modelos:	NGC, NGO		

			
1			
código	700745	referencia	TC3-0360 TC3-3224-1 TC3-3224-2
descripción	bisagra de puerta pos. de montaje derecho apto para TURBOCHEF C3		
Para modelos:	C3, C3D		
repuestos para	700745		
	código	691425	referencia
			C0504 T0504
	 anillo de PTFE ø 8mm apto para TURBOCHEF C3		

Continúa en la página siguiente

repuestos para	700745		
	código	700746	referencia
			C0508-1 C0508-2 T0508
cojinete pos. de montaje derecho para bisagra de puerta batiente apto para TURBOCHEF C3			

	1		
---	---	--	--

código	700743	referencia	TC3-0360 TC3-3224-1 TC3-3224-2
---------------	--------	-------------------	--------------------------------------

descripción	bisagra de puerta pos. de montaje izquierdo apto para TURBOCHEF C3		
--------------------	--	--	--

repuestos para	700743		
	código	691425	referencia
			C0504 T0504
anillo de PTFE ø 8mm apto para TURBOCHEF C3			

	código	700744	referencia
			C0508-1 C0508-2 T0508
cojinete pos. de montaje izquierdo para bisagra de puerta batiente apto para TURBOCHEF C3			

otros

	1		
--	---	--	--

código	691194	referencia	NGC-1061
---------------	--------	-------------------	----------

descripción	bloque de bisagras		
--------------------	--------------------	--	--

Para modelos:	NGC, NGO		
----------------------	----------	--	--

accesorios

cojinete

	1		
---	---	--	--

código	700746	referencia	C0508-1 C0508-2 T0508
---------------	--------	-------------------	-----------------------------

descripción	cojinete pos. de montaje derecho para bisagra de puerta batiente apto para TURBOCHEF C3		
--------------------	---	--	--

Para modelos:	C3, C3AB, C3D, C3-MULTI		
----------------------	-------------------------	--	--

	1		
--	---	--	--

código	700744	referencia	C0508-1 C0508-2 T0508
---------------	--------	-------------------	-----------------------------

descripción	cojinete pos. de montaje izquierdo para bisagra de puerta batiente apto para TURBOCHEF C3		
--------------------	---	--	--

filtros

filtros para aparatos

	1		
--	---	--	--

código	691412	referencia	C0185 T0185
---------------	--------	-------------------	----------------

descripción	filtro L 177mm An 240mm H 38mm para microondas inox		
--------------------	---	--	--

Para modelos:	C3, C3AB, C3C, C3C-MULTI, C3D, C3-MULTI		
----------------------	---	--	--

	1		
--	---	--	--

código	691428	referencia	HHB-8114
---------------	--------	-------------------	----------

descripción	filtro L 205mm An 128mm H 3mm aluminio para microondas espesor 3mm		
--------------------	--	--	--

Para modelos:	HHB		
----------------------	-----	--	--

accesorios para	691428		
------------------------	--------	--	--

	código	691429	referencia
			HHB-8115
resorte para filtro apto para TURBOCHEF HHB			

catalizadores

para microondas

	1		
--	---	--	--

código	691442	referencia	NGC-3065
---------------	--------	-------------------	----------

descripción	catalizador kit de servicio apto para TURBOCHEF NGC		
--------------------	---	--	--

Para modelos:	NGC		
----------------------	-----	--	--





1

código	691468	referencia	NGC-1012
descripción	catalizador TURBOCHEF NGC		
Para modelos:	NGC		

accesorios

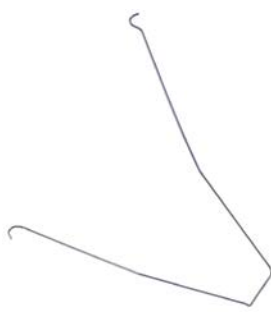
material de sujeción



1

código	691429	referencia	HHB-8115
descripción	resorte para filtro apto para TURBOCHEF HHB		
Para modelos:	HHB		

pies para aparatos y tapas terminales

pies para aparatos

con fijación atornillada



1

código	691381	referencia	100781
descripción	pie de aparato tubo ø 30mm rosca 3/8" NPT rosca L 11mm H 102-140mm acero cromado medida 1 1/4" UE 1 pzs		
Para modelos:	C3, NGC, NGO		

rejillas y rieles guía

parrillas

universal

sin reborde

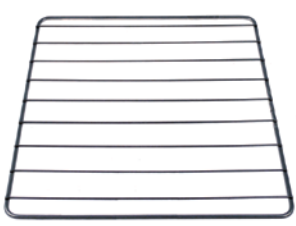

1

código	970625	referencia	NGC-1064-1
descripción	parrilla An 360mm P 395mm acero inoxidable apto para refrigerador		
Para modelos:	NGC		

específico del fabricante

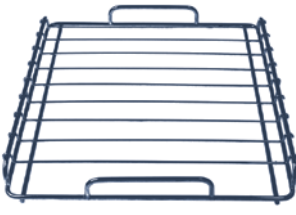

1

código	691458	referencia	NGC-3064
descripción	parrilla An 395mm P 365mm H 45mm apto para refrigerador para fondos calentadores DUNKIN DONUTS		
Para modelos:	NGC		

rieles guía y soportos

específico del fabricante



1

código	691417	referencia	HHB-3210
descripción	guida forma U L 465mm pos. de montaje izquierdo/derecho		
Para modelos:	HHB, HHB2		

juntas

juntas térmicas

juntas para puertas



código	691434	referencia	HHB-8101
descripción	junta de puerta perfil 2951 An 243mm L 490mm medidas exteriores UE 1 para Turbochef 12 orificios		
Para modelos:	HHB		

anillos de junta

juntas de PTFE



código	691377	referencia	700-1333
descripción	junta plana PTFE ø ext. 235mm int.ø 230mm espesor 4mm UE 1 pzs para Turbochef		
Para modelos:	C3, C3AB, C3C, C3C-MULTI, C3D, C3-MULTI		

juntas especiales

para microondas



código	900796	referencia	T0325 TC3-3227
descripción	junta L 1100mm silicona		
Para modelos:	C3, C3AB, C3D, C3-MULTI		



código	691384	referencia	NGC-3014
descripción	junta L 175mm cobre tejido para Magnetron		
Para modelos:	NGC		



código	691385	referencia	102021
descripción	junta L 315mm cobre tejido para microondas		
Para modelos:	NGC		

técnica de accionamiento y rodamientos de bolas

rodamientos de bolas

cojinetes a bolas pulgadas



código	691423	referencia	T0541
descripción	rodamiento de bolas tipo CYR3/45 árbol ø 1/4"mm ø ext. 3/4"mm An 1/2"mm		
Para modelos:	C3, C3AB, C3D, C3-MULTI		

correas de accionamiento

correas dentada

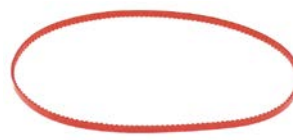

código	691427	referencia	T0284
descripción	correa dentada perfil MXL L 320mm H 1mm dientes 165 división 1-1 PVC CODE 6G16 An 3mm apto para TURBOCHEF C3		
Para modelos:	C3, C3AB, C3C, C3C-MULTI, C3D, C3-MULTI		

muelles

muelles de torsión



código	691401	referencia	NGC-1087
descripción	resorte de torsión cierre de puerta		
Para modelos:	NGC		

resortes de tracción



código	700749	referencia	C0542 T0542
descripción	muelle de tracción ø 19mm longitud total 220mm espesor de hilo 2mm		
Para modelos:	C3, C3AB, C3C, C3C-MULTI, C3D, C3-MULTI		



			
código	700748	referencia	C0708 T0708
descripción	muelle de tracción ø 8.5mm longitud total 95mm espesor de hilo 1mm		
Para modelos:	C3, C3C, C3C-MULTI, C3D		

herramientas

herramientas de mano

destornilladores

vasos

			
código	801637 ¹	referencia	102755
descripción	punta Torx estándar con taladro tamaño T15H L 25mm		
Para modelos:	C3, C3D, NGC		

¹con taladro

			
código	801638 ¹	referencia	102767
descripción	punta Torx estándar con taladro tamaño T20H L 25mm		
Para modelos:	HHC3240		

¹con taladro

			
código	801864	referencia	102746
descripción	punta para tornillos de seguridad tamaño 4,0mm L 25mm		
Para modelos:	C3		

sistemas de medición

medidores

medidores de presión

manómetros digitales

medición de presión absoluta

			
código	541583	referencia	HHC-3001
descripción	medidor de presión 0,05-50mbar tipo 476A medida de la presión tipo de sensor sonda de presión absoluta unidad de medida mbar/psi/in.Hg/kPa/w.c./mmHg empalmes 1 On/Off/Zero resolución 0,01 mbar tubo ø 6/8mm precisión (temperatura) ±0,05%FS precisión (histéresis) ±0,1%FS sobrecarga máx. 0,34 bar interfaz sensor piezoresistiver Relativdruck-Sensor, intern medidas 150x72x23mm bolsa incluida		
Para modelos:	HHC3240		

material de sujeción

tornillos

tornillos de chapa

			
código	560108	referencia	101688
descripción	tornillos de chapa ø 4.2mm L 13mm inox UE 20 pzs DIN 7981/ISO 7049 ø cabezal 8.2mm cabeza gota de sebo		
Para modelos:	HHB, HHB2, NGC		

			
código	560348	referencia	102752
descripción	tornillo de chapa ø 4.2mm L 13mm inox UE 1 pzs 14585 soporte torx de seguridad ø cabezal 7.8mm		
Para modelos:	i3, i5, NGC		

tornillos de cabeza avellanada

			
1			
código	691393	referencia	102809
descripción	tornillo de cabeza avellanada rosca 8/32" UNC L 9.3mm inox UE 1 pzs soporte Phillips ø 7.5mm		
Para modelos:	HHB, NGC		

tornillos de cabeza de gota de sebo

			
1			
código	691467	referencia	102748
descripción	tornillo de cabeza de gota de sebo rosca 8/32" UNC L 9.3mm inox soporte torx de seguridad UE 1 pzs		
Para modelos:	C3, C3D, NGC		

tuercas hexagonales

			
1			
código	691404	referencia	101381
descripción	tornillo de cabeza hexagonal rosca 10/32" UNF rosca L 12mm inox EC 8 UE 1 pzs		
Para modelos:	NGC		

tornillos de cabeza moleteada

			
1			
código	505255	referencia	101752
descripción	tornillo rosca 1/4" rosca L 13mm ø 15mm H 22.5mm inox		
Para modelos:	HHC2020, HHC3240		

tuercas

tuercas hexagonales

tuercas hexagonales pulgadas

			
1			
código	691394	referencia	102962
descripción	tuerca rosca 8/32" UNC H 4mm inox EC 9 UE 1 pzs con arandela dentada		
Para modelos:	NGC		

arandelas

arandelas elásticas

			
1			
código	691309	referencia	102350
descripción	arandela grower int.ø 5mm ø ext. 8.3mm acero inoxidable UE 1 pzs		
Para modelos:	HHB, HHB2, NGC		

arandelas

otros

			
1			
código	691294	referencia	102140
descripción	arandela int.ø 5.3mm ø ext. 11mm espesor 0.8mm inox UE 1 pzs para rosca M5		
Para modelos:	NGC		

sujeciones

clips de fijación

			
1			
código	691449	referencia	T0337
descripción	clip de sujeción ø nominal 4mm L 25mm An 11mm distancia de sujeción 18mm		
Para modelos:	C3, C3D, NGC		

anillos truarc

DIN 471

			
1			
código	691403	referencia	101312
descripción	anillo truarc árbol ø 19mm espesor 1.2mm acero inoxidable DIN 471		
Para modelos:	NGC		

DIN 6799

			
1			
código	516198	referencia	101297
descripción	anillo truarc E D1 ø 6mm D2 ø 12mm inox DIN 6799 espesor 0.7mm para árbol ø 7-9mm		
Para modelos:	HHB		



consumibles

sellantes y pegamentos

silicona de alta temperatura



1

código	890243	referencia	102563 102567
descripción	silicona de alta temperatura PERMATEX HIGH-TEMP RED RTV SILICONE 85g T máx 343°C tubo		
descripción	PERMATEX RTV RED SILICONE - tubo 85g - rojo Una silicona de alta temperatura especialmente desarrollada para servicio pesado. Compensa casi cualquier junta de corte. Resiste fiablemente la formación de grietas, las contracciones y deformaciones durante los cambios de temperatura. Rango de temperatura: -54°C a +343°C		
Para modelos:	i3, i5, NGC		

cintas adhesivas



1

código	691405	referencia	102698 Roll 102698 Rolle
descripción	cinta adhesiva aluminio sistemas de ventilación An 73mm		
descripción	Cinta adhesiva de blindaje de aluminio - 73 mm de ancho, 45 metros Lámina de aluminio de 40 micras, recubierta con adhesivo conductor de la electricidad. La cinta está provista de un papel separador siliconado. - Adhesivo acrílico conductor - Buena acción de blindaje y conductividad del eje z B160 - Buena resistencia a altas y bajas temperaturas (-20°C a +155°C) - Buena resistencia a los productos químicos, al calor, a los ácidos y sales alcalinas - Fácil de desenrollar		

lubricantes

grasas de silicona



1

código	890245	referencia	100639 NGC-3006
descripción	grasa de silicona Turbochef jeringa 20ml		
descripción	TurboChef grasa de silicona - jeringa 20ml Grasa de silicona para lubricación de muelles de interruptores de puerta, etc.		
Para modelos:	NGC		

detergentes

diversos detergentes



1

código	801172	referencia	103180 103180 CS
descripción	detergente 1l TURBOCHEF Oven Cleaner		

fusibles

fusibles finos

ø10,4x35/38mm 600V (USA)



1

código	358836	referencia	100592 100596
descripción	fusible fino medida ø10,4x35(38)mm 12A rápido nominal 600V tipo ATMR/KTK-R UE 1 pzs		
Para modelos:	C3, C3AB, C3C, C3C-MULTI, C3D, C3-MULTI, HHB, HHB2, i3, i5, NGC, NGO		



1

código	358837	referencia	100599
descripción	fusible fino medida ø10,4x35(38)mm 20A rápido nominal 600V tipo ATMR/KTK-R UE 1 pzs		
Para modelos:	HHC2020, HHC3240, i3, NGC, NGO		



1

código	358838	referencia	100597
descripción	fusible fino medida ø10,4x35(38)mm 25A rápido nominal 600V tipo ATMR/KTK-R UE 1 pzs		
Para modelos:	C3, C3C		



1

código	358009	referencia	100593
descripción	fusible tamaño 10,3x38mm 12A nominal 600V UE 1 pzs		
Para modelos:	C3D, i5		

portafusibles



1

código	550829	referencia	103548
descripción	portafusibles 30A nominal 800V L 77mm An 41mm H 33mm empalme F6,3x0,8		
Para modelos:	HHB2, HHC2020, HHC3240, i3, i5		

A			
accesorios eléctricos	20	medidores	29
anillos de junta	28	medidores de presión	29
anillos truarc	30	microinterruptores	4
arandelas	30	motores	17
arandelas elásticas	30	motores de aire caliente	14
B		P	
bisagras para hornos	25	parrillas	27
C		R	
cables	20	rejillas y rieles guía	27
cables de alimentación aparatos	20	relés	6
cables de cinta plana	20	resistencia de microondas	3
cables de encendido	22	resistencias	3
cables de enlace	20	resistencias circulación de aire	3
cintas adhesivas	31	S	
clips de fijación	30	sellantes y pegamentos	31
condensadores de alta tensión	18	semiconductores de potencia	5
condensadores y filtros antiparasitarios	18	señalizadores de alarma	5
consumibles	31	sensores	8
D		silicona	31
destornilladores	29	silicona de alta temperatura	31
detergentes	31	sistemas de medición	29
F		sujeciones	30
filtros	18	T	
fusibles	19, 31	terminales	20
fusibles finos	31	termostatos	4
G		termostatos de seguridad	4
grasas de silicona	31	termostatos de superficie	4, 4
H		tornillos	29
herramientas	29	tornillos de cabeza avellanada	30
herramientas de mano	29	tornillos de cabeza de gota de sebo	30
I		tornillos de cabeza moleteada	30
interruptores magnéticos	5	tornillos de chapa	29
interruptores y pulsadores	4	transformadores	7
J		tuercas	30
juntas para puertas	28	tuercas hexagonales	30, 30
juntas térmicas	28	U	
L		unidades de calentamiento	3
lubricantes	31	V	
M		vasos	29
magnetrones	7	ventilador axial	13
material de sujeción	29	ventiladores	13
		ventiladores de aire caliente	15
		ventiladores radiales	17