



GAS



ELEKTRO



WASSER



MECHANIK



WERKZEUG

Ersatzteile passend für

VIBIEMME

Das komplette Sortiment finden Sie immer aktuell im GEV-Webshop

Hersteller-Kataloge

Für jeden Hersteller die wichtigsten Ersatz- und Zubehörteile übersichtlich zusammengestellt



- ✓ **Komplettes Sortiment und alle Gerätedaten immer aktuell im GEV-Webshop**
- ✓ **Alphabetischer Index am Ende des Katalog**

GEV-Webshop

www.gev-online.de

www.gev-online.ch







- 🔍 Artikel als Favoriten markieren
- 🔍 Einloggen mit E-Mail-Adresse und gewohntem Passwort
- 🔍 Komfort-Bestellung – mehrere Artikel gleichzeitig in den Warenkorb legen
- 🔍 Sofort Artikel suchen ohne Anmeldung



Heizkörper

Heizkörper für Kaffeemaschinen



| | | | |
|--|---|-------------------|---------------------|
|  <p>1</p> | | | |
| GEV-Nr. | 417081 | Vergl.-Nr. | ELETRESD1422 |
| Beschreibung | Heizkörper 1350W 230V HK 1 Gewinde 1" L 140mm B 22mm H 23mm Rohr ø 8.5mm Anschluss 6.3 Tauchheizkörper Schraubflansch | | |
| Für Modelle: | Domobar-Interruttore-Levetta, Domobar-Interruttore-Luminoso | | |
| Zubehör für | 417081 | | |
|  | GEV-Nr. | 510404 | Vergl.-Nr. — |
| | Flachdichtung Fiber AD ø 44mm ID ø 34mm Materialstärke 2mm VPE 1 Stück | | |
|  | GEV-Nr. | 528018 | Vergl.-Nr. — |
| | Flachdichtung PTFE AD ø 41mm ID ø 33mm Materialstärke 3mm Größe 1" VPE 1 Stück | | |



| | | | |
|--|--|-------------------|------------------------------|
|  <p>1</p> | | | |
| GEV-Nr. | 417498 | Vergl.-Nr. | ELETRESSM1822 UNK30335220 |
| Beschreibung | Heizkörper 1800W 230V HK 1 Gewinde 1 1/4" L 140mm B 26mm H 26mm Rohr ø 8.5mm Anschluss Flachstecker 6,3mm Tauchheizkörper AL 15mm Kaffeetechnik SW 37 Kupfer | | |
| Für Modelle: | Domobar-Super-Elettronica, Domobar-Super-Manuale | | |

| | | | |
|--|---|-------------------|---------------|
|  <p>1</p> | | | |
| GEV-Nr. | 417030 | Vergl.-Nr. | ELETRES1G1822 |
| Beschreibung | Heizkörper 1800W 230V HK 2 Einbau ø 40mm LA 57mm L 177mm B 26mm H 53mm L1 35mm L2 60mm L3 74mm H1 24mm H2 29mm Loch ø 10mm Rohr ø 8.5mm Anschluss M6 Tauchheizkörper 3-Lochflansch passend für BRASILIA, VIBIEMME | | |

| | | | |
|--|--|-------------------|--------------------------------|
|  <p>1</p> | | | |
| GEV-Nr. | 417150 | Vergl.-Nr. | ELETRES2G2722 ELETRES2G2724 |
| Beschreibung | Heizkörper 2700W 230V HK 2 Einbau ø 38.5mm LA 57mm L 252mm B 26mm H 65mm L1 30mm L2 42mm L3 180mm H1 24mm H2 40mm Windungen 3 Loch ø 11mm Anschluss M6x1 Tauchheizkörper 3-Lochflansch | | |
| Für Modelle: | Minimax-Kometa-Elettronica, Minimax-Kometa-Pulsante, Minimax-Replica-Elettronica | | |
| Zubehör für | 417150 | | |
|  | GEV-Nr. | 528012 | Vergl.-Nr. N/A |
| | Dichtung passend für VIBIEMME für Heizkörper | | |

| | | | |
|---|---|-------------------|--------------------------------|
|  <p>1</p> | | | |
| GEV-Nr. | 417348 | Vergl.-Nr. | ELETRES2G3522 ELETRES2G4023 |
| Beschreibung | Heizkörper 4000W 230V HK 2 Einbau ø 38.5mm LA 57mm L 330mm B 28mm H 55mm L1 25mm L2 70mm L3 235mm H1 25mm H2 30mm Windungen 2 Loch ø 11mm Rohr ø 8.5mm Anschluss M6 Tauchheizkörper 3-Lochflansch | | |
| Für Modelle: | Cubo-2gr-Elettronico, Cubo-2gr-Manuale, Evolution-2gr-elettronica-e-puls, Lollo-2gruppi, Replica-elettronica-2gr, Replica-manuale-2gr, Replica-pulsante-2gr, Revolution-2gr-elettronica-epuls | | |
| Zubehör für | 417348 | | |
|  | GEV-Nr. | 528013 | Vergl.-Nr. — |
| | Dichtung ID ø 40mm Fiber Materialstärke 4mm Loch ø 11mm LA 57mm für Heizkörper Kaffeetechnik | | |

| | | | |
|---|--|-------------------|---------------------|
|  <p>1</p> | | | |
| GEV-Nr. | 417159 | Vergl.-Nr. | N/A |
| Beschreibung | Heizkörper 4000W 380V HK 2 Einbau ø 40mm LA 57mm L 492mm B 26mm H 72mm L1 35mm L2 60mm L3 397mm H1 24mm H2 48mm Windungen 2 Loch ø 10mm Rohr ø 6.3mm Anschluss M5 Tauchheizkörper 3-Lochflansch passend für VIBIEMME | | |
| Zubehör für | 417159 | | |
|  | GEV-Nr. | 528013 | Vergl.-Nr. — |
| | Dichtung ID ø 40mm Fiber Materialstärke 4mm Loch ø 11mm LA 57mm für Heizkörper Kaffeetechnik | | |

| | | | |
|---|---|-------------------|--------------------------------|
|  <p>1</p> | | | |
| GEV-Nr. | 417439 | Vergl.-Nr. | ELETRES3G4522 ELETRES3G5023 |
| Beschreibung | Heizkörper 5000W 230V HK 2 Einbau ø 39mm LA 57mm L 455mm B 25mm H 51mm L1 35mm L2 65mm L3 335mm H1 25mm H2 26mm Windungen 2 | | |
| Für Modelle: | Cubo-3gr-Elettronico, Cubo-3gr-Manuale, Evolution-3gr-elettronica-e-puls, Lollo-3gruppi, Replica-elettronica-3gr, Replica-manuale-3gr, Replica-pulsante-3gr, Revolution-3gr-elettronica-epuls | | |
| Zubehör für | 417439 | | |
|  | GEV-Nr. | 528013 | Vergl.-Nr. — |
| | Dichtung ID ø 40mm Fiber Materialstärke 4mm Loch ø 11mm LA 57mm für Heizkörper Kaffeetechnik | | |

Zubehör

Dichtungsringe

Fiberdichtungen

| | | | |
|--|---|-------------------|-----|
|  <p>1</p> | | | |
| GEV-Nr. | 510405 | Vergl.-Nr. | N/A |
| Beschreibung | Flachdichtung Fiber AD ø 56mm ID ø 42mm Materialstärke 2mm für Gewinde 1 1/4" VPE 1 Stück | | |

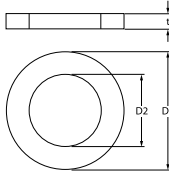

PTFE-Dichtungen

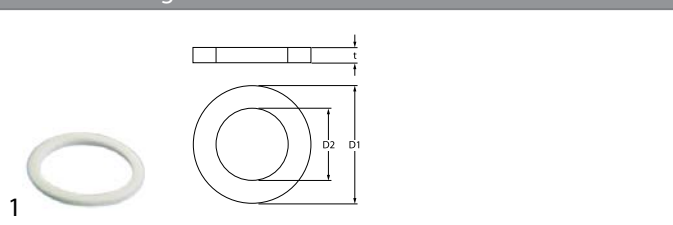

| | | | |
|---------------------|---|-------------------|---------------|
| GEV-Nr. | 528021 | Vergl.-Nr. | GUARRESPICTEF |
| Beschreibung | Flachdichtung PTFE AD ø 53mm ID ø 42.5mm Materialstärke 3mm VPE 1 Stück Vergl.-Nr. 12001/02286 passend für Astoria/Aurora/Brazilia/Wega | | |
| Für Modelle: | Domobar-Super-Elettronica, Domobar-Super-Manuale, Lollo-1gruppo | | |

Flanschdichtungen



| | | | |
|---------------------|--|-------------------|-----------------------|
| GEV-Nr. | 528740 | Vergl.-Nr. | GUARRESTR UNK70406620 |
| Beschreibung | Dichtung ID ø 44mm PTFE Materialstärke 3.5mm Loch ø 9.5mm LA 58mm passend für ITALCREM, VISACREM für Heizkörper Kaffeetechnik | | |
| Für Modelle: | Chimaera, Cubo-2gr-Elettronico, Cubo-2gr-Manuale, Cubo-3gr-Elettronico, Cubo-3gr-Manuale, Cubo-4gr-Elettronico, Cubo-4gr-Manuale, Evolution-2gr-elettronica-e-puls, Evolution-3gr-elettronica-e-puls, Lollo-2gruppi, Lollo-3gruppi, Minimax-Kometa-Elettronica, Minimax-Kometa-Pulsante, Minimax-Replica-Elettronica, Replica-2gr-elettronica-multiboiler, Replica-2gr-manuale-multiboiler, Replica-3gr-elettronica-multiboiler, Replica-3gr-manuale-multiboiler, Replica-elettronica-2gr, Replica-elettronica-3gr, Replica-elettronica-4gr, Replica-manuale-2gr, Replica-manuale-3gr, Replica-manuale-4gr, Replica-pulsante-2gr, Replica-pulsante-3gr, Replica-pulsante-4gr, Revolution-2gr-elettronica-epuls, Revolution-3gr-elettronica-epuls | | |

| | | | |
|---------------------|--|-------------------|-----|
| GEV-Nr. | 528012 | Vergl.-Nr. | N/A |
| Beschreibung | Dichtung passend für VIBIEMME für Heizkörper | | |

Thermostate

Anlegethermostate

Anlege-Sicherheitsthermostate

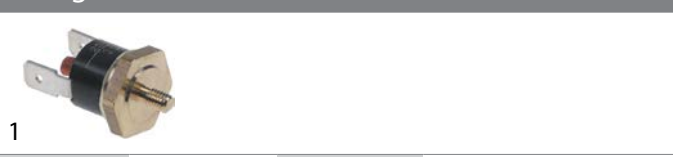

| | | | |
|---------------------|--|-------------------|---------------|
| GEV-Nr. | 390740 | Vergl.-Nr. | ELETGLDOMM165 |
| Beschreibung | Anlegethermostat Lamm Abschalttemp. 165°C 1NC 16A Anschluss F6,3 | | |
| Für Modelle: | Domobar-Junior-2B, Domobar-Junior-HX, Domobar-Super-2b-Pid-Elettronica, Domobar-Super-2b-Pid-Manuale | | |

| | | | |
|---------------------|--|-------------------|-------------------------|
| GEV-Nr. | 390688 | Vergl.-Nr. | ELETSALRESUL UNK6264978 |
| Beschreibung | Sicherheits-Anlegethermostat LA 39mm Abschalttemp. 130°C 2NC 2-polig 10A Anschluss Flachstecker 3,2mm Einbau ø 31mm | | |
| Für Modelle: | Evolution-2gr-elettronica-e-puls, Evolution-3gr-elettronica-e-puls, Revolution-2gr-elettronica-epuls, Revolution-3gr-elettronica-epuls | | |

Anlegethermostate

| | | | |
|---------------------|--|-------------------|--------------|
| GEV-Nr. | 390739 | Vergl.-Nr. | ELETGLDOM128 |
| Beschreibung | Anlegethermostat LA 23.5mm Abschalttemp. 130°C 1NC 1-polig 16A 250V Anschluss F6,3 | | |
| Für Modelle: | Chimaera, Domobar-Super-2b-Pid-Elettronica, Domobar-Super-2b-Pid-Manuale, Replica-2gr-elettronica-multiboiler, Replica-2gr-manuale-multiboiler, Replica-3gr-elettronica-multiboiler, Replica-3gr-manuale-multiboiler | | |

Regel- und Sicherheitsthermostate

PRODIGY / FIRT

| | | | |
|---------------------|--|-------------------|--------------|
| GEV-Nr. | 390716 | Vergl.-Nr. | ELETEDOMJU2B |
| Beschreibung | Thermostat T.max. 55°C Arbeitsbereich°C 1-polig 1CO 16A Fühler ø 6.5mm Fühler L 90mm Kapillarrohr 1700mm Kapillarrohr isoliert 1500mm Stopfbuchse M14x1 Achse ø 6x4,6mm Achslänge 6mm Achsstellung unten Drehwinkel 315° Fühlermaterial Kupfer | | |
| Für Modelle: | Domobar-Interruttore-Levetta, Domobar-Interruttore-Luminoso, Domobar-Junior-2B | | |

| | | | |
|---|---|-------------------|-----------|
|  | | | |
| 1 | | | |
| GEV-Nr. | 390626 | Vergl.-Nr. | ELETTEDOM |
| Beschreibung | Thermostat T.max. 55°C Arbeitsbereich°C 1-polig 1CO 16A Fühler ø 6mm Fühler L 72mm Kapillarrohr 700mm Kapillarrohr isoliertmm Stopfbuchse Achse ø 6x4,6mm Achslänge 6mm Achsstellung oben Drehwinkel 270° Fühlermaterial Kupfer | | |

| | | | |
|---|--|-------------------|--------------|
|  | | | |
| 1 | | | |
| GEV-Nr. | 346502 | Vergl.-Nr. | ELETPULCMDOM |
| Beschreibung | Druckschalter Einbaumaß 28,5x28,5mm rot/grün 2NO 250V 16A Anschluss Flachstecker 6,3mm Umgebungstemperatur max. 150°C Schutzart IP40 mit Indikator | | |
| Für Modelle: | Replica-pulsante-2gr, Replica-pulsante-3gr, Replica-pulsante-4gr | | |

Schalter und Taster

Wippenschalter/-taster

| | | | |
|---|---|-------------------|---------------|
| 30x22mm | | | |
|  | | | |
| 1 | | | |
| GEV-Nr. | 346896 ¹ | Vergl.-Nr. | ELETINTBIPSIN |
| Beschreibung | Wippenschalter Einbaumaß 30x22mm schwarz 2NO 250V 16A 0-I Anschluss Flachstecker 6,3mm Umgebungstemperatur max. 125/55°C Schutzart IP65 | | |

¹nicht beleuchtet

| | | | |
|---|--|-------------------|-------------|
| ø25mm | | | |
|  | | | |
| 1 | | | |
| GEV-Nr. | 346496 | Vergl.-Nr. | ELETINTNLST |
| Beschreibung | Druckschalter Einbau ø 25mm rot 2NO 250V 16A Anschluss Flachstecker 6,3mm Umgebungstemperatur max. 85°C Schutzart IP40 | | |

| | | | |
|---|---|-------------------|--------------|
|  | | | |
| 1 | | | |
| GEV-Nr. | 345160 ¹ | Vergl.-Nr. | ELETINTGLUSE |
| Beschreibung | Druckschalter Einbau ø 25mm rot 2NO 250V 16A beleuchtet Anschluss Flachstecker 6,3mm Umgebungstemperatur max. 85°C Schutzart IP40 | | |
| Für Modelle: | Domobar-Interruttore-Luminoso | | |

¹beleuchtet

| | | | |
|---|--|-------------------|---------------------------|
|  | | | |
| 1 | | | |
| GEV-Nr. | 347343 | Vergl.-Nr. | ELETPULINTKOR UNK32276239 |
| Beschreibung | Wippenschalter Einbaumaß 30x22mm weiß/weiß 1NO/1NO 250V 16A Tassenwärmer/0 Anschluss Flachstecker 6,3mm Umgebungstemperatur max. 85°C Schutzart IP40 | | |
| Für Modelle: | Lollo-1gruppo, Lollo-2gruppi, Lollo-3gruppi | | |

| | | | |
|---|---|-------------------|--------------|
|  | | | |
| 1 | | | |
| GEV-Nr. | 346497 | Vergl.-Nr. | ELETINTVLUSE |
| Beschreibung | Druckschalter Einbau ø 25mm rot 2NO 250V 16A beleuchtet Dampf Anschluss Flachstecker 6,3mm Umgebungstemperatur max. 85°C Schutzart IP40 | | |
| Für Modelle: | Domobar-Interruttore-Luminoso | | |

Druckschalter/-taster

| | | | |
|---|--|-------------------|---------------|
| 28,5x28,5mm | | | |
|  | | | |
| 1 | | | |
| GEV-Nr. | 345142 | Vergl.-Nr. | ELETPULCMDOMT |
| Beschreibung | Druckschalter Einbaumaß 28,5x28,5mm rot/grün 2NO 250V 16A Anschluss Flachstecker 6,3mm Umgebungstemperatur max. 150°C Schutzart IP40 mit Indikator | | |
| Für Modelle: | Minimax-Kometa-Elettronica, Minimax-Kometa-Pulsante | | |

| | | | |
|---|--|-------------------|--------------|
|  | | | |
| 1 | | | |
| GEV-Nr. | 346504 | Vergl.-Nr. | ELETINTALUSE |
| Beschreibung | Druckschalter Einbau ø 25mm rot 2NO 250V 16A beleuchtet Wasser Anschluss Flachstecker 6,3mm Umgebungstemperatur max. 85°C Schutzart IP40 | | |
| Für Modelle: | Domobar-Interruttore-Luminoso | | |

| Sonstige | | | |
|---|--|-------------------|---------------|
|  | | | |
| GEV-Nr. | 347349 | Vergl.-Nr. | ELETPULBIPDOR |
| Beschreibung | Druckschalter schwarz 2NO 250V 16A Anschluss Flachstecker 6,3mm Umgebungstemperatur max. 85°C Schutzart IP40 | | |
| Für Modelle: | Domobar-Super-Elettronica, Domobar-Super-Manuale, Evolution-2gr-elettronica-e-puls, Evolution-3gr-elettronica-e-puls, Minimax-Replica-Elettronica, Replica-2gr-elettronica-multiboiler, Replica-3gr-elettronica-multiboiler, Replica-elettronica-2gr, Replica-elettronica-3gr, Replica-elettronica-4gr, Revolution-2gr-elettronica-epuls, Revolution-3gr-elettronica-epuls | | |

| Hebelschalter | | | |
|---|--|-------------------|---------------|
| M12x0,75 | | | |
|  | | | |
| GEV-Nr. | 347462 | Vergl.-Nr. | ELETINTLEVMET |
| Beschreibung | Hebelschalter Gewinde M12x0,75 2CO 250V 15A ON-ON | | |
| Für Modelle: | Domobar-Interruttore-Levetta, Domobar-Junior-2B, Domobar-Junior-HX | | |

| Mikroschalter | | | |
|---|---|-------------------|-----------|
| hebelbetätigt | | | |
|  | | | |
| GEV-Nr. | 345044 | Vergl.-Nr. | ELETMICP1 |
| Beschreibung | Mikroschalter mit Hebel 250V 16A 1CO Anschluss Flachstecker 6,3mm Umgebungstemperatur max. 85°C BA 25mm Typ C99ZP3 Betätigungskraft: 25g Hebellänge 71mm | | |
| Für Modelle: | Domobar-Interruttore-Levetta, Domobar-Interruttore-Luminoso, Domobar-Super-2b-Pid-Elettronica, Domobar-Super-2b-Pid-Manuale, Domobar-Super-Elettronica, Domobar-Super-Manuale | | |

| stiftbetätigt | | | |
|---|--|-------------------|-----------|
| M10 | | | |
|  | | | |
| GEV-Nr. | 345156 | Vergl.-Nr. | ELETMICRE |
| Beschreibung | Mikroschalter mit Druckstift Gewinde M10x1 Gewinde L 13mm 250V 16A 1CO Anschluss Flachstecker 6,3mm Hub 6mm BA 25mm L 46mm L1 13mm Umgebungstemperatur max. 85°C Typ C4AZN3 Betätigungskraft: 340g | | |
| Für Modelle: | Cubo-2gr-Manuale, Cubo-3gr-Manuale, Cubo-4gr-Elettronico, Domobar-Interruttore-Levetta, Domobar-Interruttore-Luminoso, Domobar-Super-2b-Pid-Manuale, Domobar-Super-Elettronica, Domobar-Super-Manuale, Replica-2gr-manuale-multiboiler, Replica-3gr-manuale-multiboiler, Replica-manuale-2gr, Replica-manuale-3gr, Replica-manuale-4gr, Replica-pulsante-2gr | | |

| Sonderbauformen | | | |
|--|--------------------------------------|-------------------|---------------|
|  | | | |
| Bild nicht vorhanden | | | |
| GEV-Nr. | 347463 | Vergl.-Nr. | ELETMICREKIRI |
| Beschreibung | Mikroschalter Typ NR6X5 | | |
| Für Modelle: | Domobar-Junior-2B, Domobar-Junior-HX | | |

| Systemschalter ROLD | | | |
|--|--|-------------------|----------------------------|
|  | | | |
| GEV-Nr. | 347181 | Vergl.-Nr. | ELETPULTASCRD UNK85036766 |
| Beschreibung | Drucktaste Größe 13x17mmmm verchromt | | |
| Für Modelle: | Domobar-Super-Elettronica, Domobar-Super-Manuale, Evolution-2gr-elettronica-e-puls, Evolution-3gr-elettronica-e-puls, Minimax-Replica-Elettronica, Replica-2gr-elettronica-multiboiler, Replica-3gr-elettronica-multiboiler, Replica-elettronica-2gr, Replica-elettronica-3gr, Replica-elettronica-4gr, Revolution-2gr-elettronica-epuls, Revolution-3gr-elettronica-epuls | | |
| Zubehör für | 347181 | | |
| GEV-Nr. | 347182 | Vergl.-Nr. | ELETPULSU-POVD UNK80981726 |
| Beschreibung | Elementträger Einbaumaß 20,6x16,4mm verchromt gewölbt für Drucktasten 13x17mm | | |

| | | | |
|--|--|-------------------|---------------------------|
|  | | | |
| GEV-Nr. | 347182 | Vergl.-Nr. | ELETPULSUPOVD UNK80981726 |
| Beschreibung | Elementträger Einbaumaß 20,6x16,4mm verchromt gewölbt für Drucktasten 13x17mm | | |
| Für Modelle: | Domobar-Super-Elettronica, Domobar-Super-Manuale, Evolution-2gr-elettronica-e-puls, Evolution-3gr-elettronica-e-puls, Minimax-Replica-Elettronica, Replica-2gr-elettronica-multiboiler, Replica-3gr-elettronica-multiboiler, Replica-elettronica-2gr, Replica-elettronica-3gr, Replica-elettronica-4gr, Revolution-2gr-elettronica-epuls, Revolution-3gr-elettronica-epuls | | |

Drehschalter

BREMAS

Serie A1600



| | | | |
|---------------------|--|-------------------|---------|
| GEV-Nr. | 345145 | Vergl.-Nr. | ELETCOM |
| Beschreibung | Drehschalter 0-1-2 20A Achslänge 23mm Anschluss Schraubklemme 3 Schaltstellungen 6-polig Achse 5x5mm | | |
| Für Modelle: | Domobar-Super-Elettronica, Domobar-Super-Manuale, Minimax-Kometa-Elettronica, Minimax-Kometa-Pulsante, Minimax-Replica-Elettronica | | |

Sonstige



| | | | |
|---------------------|--|-------------------|---------------|
| GEV-Nr. | 347464 | Vergl.-Nr. | ELETCOMDOMSUP |
| Beschreibung | Drehschalter | | |
| Für Modelle: | Domobar-Super-2b-Pid-Elettronica, Domobar-Super-2b-Pid-Manuale | | |



| | | | |
|---------------------|--|-------------------|---------------|
| GEV-Nr. | 347453 | Vergl.-Nr. | ELETCOM4STADI |
| Beschreibung | Drehschalter Stellungen 4 0-1-2-3 | | |
| Für Modelle: | Chimaera, Cubo-2gr-Elettronico, Cubo-2gr-Manuale, Cubo-3gr-Elettronico, Cubo-3gr-Manuale, Cubo-4gr-Elettronico, Cubo-4gr-Manuale, Evolution-2gr-elettronica-e-puls, Evolution-3gr-elettronica-e-puls, Replica-2gr-elettronica-multiboiler, Replica-2gr-manuale-multiboiler, Replica-3gr-elettronica-multiboiler, Replica-3gr-manuale-multiboiler, Replica-elettronica-2gr, Replica-elettronica-3gr, Replica-elettronica-4gr, Replica-manuale-2gr, Replica-manuale-3gr, Replica-manuale-4gr, Replica-pulsante-2gr, Replica-pulsante-3gr, Replica-pulsante-4gr, Revolution-2gr-elettronica-epuls, Revolution-3gr-elettronica-epuls | | |

Zubehör

Knebel



| | | | |
|---------------------|--|-------------------|--------------------------------|
| GEV-Nr. | 525172 | Vergl.-Nr. | MANCOMREPLICA MANCOMREPLICA |
| Beschreibung | Knebel ø 39mm L 19mm B 13mm Lochgröße 5x5mm poliert | | |
| Für Modelle: | Chimaera, Domobar-Super-2b-Pid-Elettronica, Domobar-Super-2b-Pid-Manuale, Domobar-Super-Elettronica, Domobar-Super-Manuale, Minimax-Kometa-Elettronica, Minimax-Kometa-Pulsante, Minimax-Replica-Elettronica, Replica-2gr-elettronica-multiboiler, Replica-2gr-manuale-multiboiler, Replica-3gr-elettronica-multiboiler, Replica-3gr-manuale-multiboiler, Replica-elettronica-2gr, Replica-elettronica-3gr, Replica-elettronica-4gr, Replica-manuale-2gr, Replica-manuale-3gr, Replica-manuale-4gr, Replica-pulsante-2gr, Replica-pulsante-3gr, Replica-pulsante-4gr | | |

Lampen

Signallampen

Signallampen 2-teilig (Linse und Signalelement)

Signallampenkappen

ø 6mm (Typ SQ-20)



| | | | |
|---------------------|--|-------------------|---------------|
| GEV-Nr. | 359806 | Vergl.-Nr. | ELETGEMMATRAS |
| Beschreibung | Signallampenkappe klar VPE 1 Stück ø 6mm | | |
| Für Modelle: | Domobar-Super-Elettronica, Domobar-Super-Manuale | | |

Signalelemente für Fassungsyp SQ



| | | | |
|---------------------|---|-------------------|---------------|
| GEV-Nr. | 359748 | Vergl.-Nr. | ELETLAMNEONRO |
| Beschreibung | Signalelement 110-250V rot Anschluss Schraubanschluss ø 8.5mm | | |
| Für Modelle: | Domobar-Super-Elettronica, Domobar-Super-Manuale, Lollo-1gruppo, Lollo-2gruppi, Lollo-3gruppi | | |



| | | | |
|---------------------|--|-------------------|---------------|
| GEV-Nr. | 359747 | Vergl.-Nr. | ELETLAMNEONVE |
| Beschreibung | Signalelement 250V grün Anschluss Klemmanschluss ø 8.5mm | | |
| Für Modelle: | Domobar-Super-Elettronica, Domobar-Super-Manuale | | |



Signallampen komplett

ø10mm

mit Schraubfassung



1

| | | | |
|---------------------|---|-------------------|---------------|
| GEV-Nr. | 359380 | Vergl.-Nr. | ELETLAMSP22CP |
| Beschreibung | Signallampe ø 10mm 230V rot Anschluss Flachstecker 6,3mm Fassung Schraubfassung | | |



1

| | | | |
|---------------------|--|-------------------|---------------|
| GEV-Nr. | 359476 | Vergl.-Nr. | ELETLAMSP22GC |
| Beschreibung | Signallampe ø 10mm 110/250V rot Anschluss Flachstecker 6,3mm | | |
| Für Modelle: | Minimax-Kometa-Elettronica, Minimax-Kometa-Pulsante, Minimax-Replica-Elettronica | | |

mit Steckfassung



1

| | | | |
|---------------------|--|-------------------|---------------|
| GEV-Nr. | 359138 | Vergl.-Nr. | ELETLAMSP22CF |
| Beschreibung | Signallampe ø 10mm rot 230V Anschluss Flachstecker 6,3mm VPE 1 Stück | | |



1

| | | | |
|---------------------|--|-------------------|---------------|
| GEV-Nr. | 360489 | Vergl.-Nr. | ELETLAMSP22EV |
| Beschreibung | Signallampe ø 10mm 110/250V rot Anschluss mit Kabel Kabellänge 1400mm Temp.Best. 120°C | | |
| Für Modelle: | Cubo-2gr-Elettronico, Cubo-2gr-Manuale, Cubo-3gr-Elettronico, Cubo-3gr-Manuale, Cubo-4gr-Elettronico, Cubo-4gr-Manuale, Evolution-2gr-elettronica-e-puls, Evolution-3gr-elettronica-e-puls, Minimax-Kometa-Elettronica, Minimax-Kometa-Pulsante, Minimax-Replica-Elettronica, Replica-elettronica-2gr, Replica-elettronica-3gr, Replica-elettronica-4gr, Replica-manuale-2gr, Replica-manuale-3gr, Replica-manuale-4gr, Replica-pulsante-2gr, Replica-pulsante-3gr, Replica-pulsante-4gr, Revolution-2gr-elettronica-epuls, Revolution-3gr-elettronica-epuls | | |

LEDs

Signalelemente

Sonstige



1

| | | | |
|---------------------|--|-------------------|---------------|
| GEV-Nr. | 360490 | Vergl.-Nr. | ELETLEEDBIACU |
| Beschreibung | LED | | |
| Für Modelle: | Cubo-2gr-Elettronico, Cubo-2gr-Manuale, Cubo-3gr-Elettronico, Cubo-3gr-Manuale, Cubo-4gr-Elettronico, Cubo-4gr-Manuale | | |

Schütze

LOVATO

Leistungsschütze



1

| | | | | |
|---|--|-------------------|-------------------|---|
| GEV-Nr. | 380705 | Vergl.-Nr. | TELERUTTOREKW | |
| Beschreibung | Leistungsschütz AC1 20A 230VAC (AC3/400V) 9A/4kW Hauptkontakte 3NO Hilfskontakte 1NO Anschluss Schraubanschluss Typ 11BG0910A230 | | | |
| Für Modelle: | Lollo-1gruppo, Lollo-2gruppi, Lollo-3gruppi | | | |
| Zubehör für | 380705 | | | |
|  | GEV-Nr. | 380057 | Vergl.-Nr. | — |
| | Hilfskontakt Kontakte 1NO/1NC AC1 10A für Schütze Serie BG Anschluss Schraubanschluss Typ BGX1011 | | | |

Leistungshalbleiter

Sonstige



1

| | | | |
|---------------------|--|-------------------|---------------|
| GEV-Nr. | 402566 | Vergl.-Nr. | RELESTATICODS |
| Beschreibung | Leistungshalbleiter HFS Phasen 1 25A 240V 4-32VDC L 58mm B 45mm mit LED Schraubanschluss Typ D-24Z25-L | | |
| Für Modelle: | Domobar-Super-2b-Pid-Elettronica | | |

Relais

Niveaurelais

GICAR



1

| | | | |
|---------------------|--|-------------------|------------|
| GEV-Nr. | 402557 | Vergl.-Nr. | ELETREGLIV |
| Beschreibung | Niveauregler 230V 50/60Hz 5A Anschluss Stecker Typ RL30/1E/2C/C | | |
| Für Modelle: | Domobar-Super-Elettronica, Domobar-Super-Manuale, Minimax-Kometa-Pulsante, Replica-2gr-manuale-multiboiler, Replica-3gr-manuale-multiboiler, Replica-manuale-2gr, Replica-manuale-3gr, Replica-manuale-4gr, Replica-pulsante-2gr, Replica-pulsante-3gr, Replica-pulsante-4gr | | |



| | | | |
|--|-------------------------------------|-------------------|---------------|
|  <p>Bild nicht vorhanden</p> <p>1</p> | | | |
| GEV-Nr. | 402875 | Vergl.-Nr. | ELETDOSPIDREG |
| Beschreibung | Niveaugler 230V Spannung AC 50/60Hz | | |
| Für Modelle: | Domobar-Super-2b-Pid-Manuale | | |

| | | | |
|---|--|-------------------|---------------|
|  <p>Bild nicht vorhanden</p> <p>1</p> | | | |
| GEV-Nr. | 402857 | Vergl.-Nr. | ELETDOSPIDREP |
| Beschreibung | Display | | |
| Für Modelle: | Replica-2gr-elettronica-multiboiler, Replica-3gr-elettronica-multiboiler | | |

Transformatoren

Ringkerntransformatoren

| | | | |
|--|--|-------------------|-------------|
|  <p>1</p> | | | |
| GEV-Nr. | 402565 | Vergl.-Nr. | UNK20636123 |
| Beschreibung | Transformator primär 2x115V sekundär 24V 75VA sekundär 0.5A 50/60Hz Typ T075.E.003 | | |
| Für Modelle: | Chimaera | | |

| | | | |
|---|--|-------------------|---------------|
|  <p>Bild nicht vorhanden</p> <p>1</p> | | | |
| GEV-Nr. | 402858 | Vergl.-Nr. | ELETPULDISPID |
| Beschreibung | Display | | |
| Für Modelle: | Replica-2gr-manuale-multiboiler, Replica-3gr-manuale-multiboiler | | |

Fühler

Herstellerspezifische Fühler

| | | | |
|--|--|-------------------|------------------------------|
| <p>Fühler</p>  <p>1</p> | | | |
| GEV-Nr. | 379452 | Vergl.-Nr. | ELETSONTEMPII UNK60538522 |
| Beschreibung | Temperaturfühler NTC Kabel Glasseide Fühler -40 bis +125°C Kabel -50 bis +350°C Anschluss Stecker Gewinde 1/4" Fühler ø3,5x20mm Kabellänge 0.24m | | |
| Für Modelle: | Chimaera, Domobar-Super-2b-Pid-Elettronica, Domobar-Super-2b-Pid-Manuale, Replica-2gr-elettronica-multiboiler, Replica-2gr-manuale-multiboiler, Replica-3gr-elettronica-multiboiler, Replica-3gr-manuale-multiboiler | | |

| | | | |
|---|----------|-------------------|---------------|
|  <p>Bild nicht vorhanden</p> <p>1</p> | | | |
| GEV-Nr. | 402860 | Vergl.-Nr. | ELETPULDISREP |
| Beschreibung | Display | | |
| Für Modelle: | Chimaera | | |

| | | | |
|--|----------------------------------|-------------------|---------------------------------|
|  <p>1</p> | | | |
| GEV-Nr. | 402873 | Vergl.-Nr. | ELEETDOSPIDELE ELETDOSPIDELE |
| Beschreibung | Display | | |
| Für Modelle: | Domobar-Super-2b-Pid-Elettronica | | |

Elektroniken

Platinen

| | | | |
|--|------------------------------|-------------------|-------------------------------|
|  <p>1</p> | | | |
| GEV-Nr. | 402442 | Vergl.-Nr. | ELETPULLIDDIGK UNK69209608 |
| Beschreibung | Anzeige Niveau ø 40mm | | |
| Für Modelle: | Lollo-2gruppi, Lollo-3gruppi | | |

| | | | |
|---|------------------------------|-------------------|-------------|
| <h3>Zentraleinheiten</h3>  <p>1</p> | | | |
| GEV-Nr. | 402161 | Vergl.-Nr. | ELETDOS3D2G |
| Beschreibung | Elektronikbox 3-gruppig 230V | | |



| | | | | |
|---|---------------------|--|-------------------|---------------|
| 1 | GEV-Nr. | 402101 | Vergl.-Nr. | ELETDOS3D2GSI |
| | Beschreibung | Elektronikbox 3-gruppig für Kaffeemaschine 230V Typ 3d 3GRCT XLC | | |



| | | | | |
|---|---------------------|---|-------------------|-----------|
| 1 | GEV-Nr. | 400776 | Vergl.-Nr. | ELETDOS30 |
| | Beschreibung | Elektronikbox für Kaffeemaschine 230/240V 50/60Hz Typ 30 MICRO ST./C NO SIC | | |
| | Für Modelle: | Domobar-Super-2b-Pid-Elettronica | | |



| | | | | |
|---|---------------------|---|-------------------|--------------|
| 1 | GEV-Nr. | 402590 | Vergl.-Nr. | ELETDOS30DOM |
| | Beschreibung | Elektronikbox für Kaffeemaschine 230/240V 50/60Hz Typ 30 MICRO ST./C NO SIC | | |
| | Für Modelle: | Domobar-Super-Elettronica, Domobar-Super-Manuale | | |



| | | | | |
|---|---------------------|--|-------------------|---------------|
| 1 | GEV-Nr. | 402859 | Vergl.-Nr. | ELETDOSRECUMP |
| | Beschreibung | Zentraleinheit | | |
| | Für Modelle: | Cubo-2gr-Manuale, Cubo-3gr-Manuale, Cubo-4gr-Elettronico, Evolution-2gr-elettronica-e-puls, Evolution-3gr-elettronica-e-puls, Revolution-2gr-elettronica-epuls, Revolution-3gr-elettronica-epuls | | |



| | | | | |
|---|---------------------|--|-------------------|---------------|
| 1 | GEV-Nr. | 403634 | Vergl.-Nr. | ELETDOSKORINE |
| | Beschreibung | Zentraleinheit 230V 50/60Hz L 127mm B 105mm für VIBIEMME | | |
| | Für Modelle: | Lollo-1gruppo, Lollo-2gruppi | | |

Dosierelektroniken

Sonstige



| | | | | |
|---|---------------------|-----------------------------------|-------------------|---------------|
| 1 | GEV-Nr. | 402868 | Vergl.-Nr. | ELETDOSKORINE |
| | Beschreibung | Dosierelektronik 1-2 gruppig 230V | | |



| | | | | |
|---|---------------------|--|-------------------|---------------|
| 1 | GEV-Nr. | 402852 | Vergl.-Nr. | ELETDOS3GRCTT |
| | Beschreibung | Dosierelektronik 230V | | |
| | Für Modelle: | Cubo-2gr-Elettronico, Cubo-3gr-Elettronico, Cubo-4gr-Manuale, Evolution-2gr-elettronica-e-puls, Evolution-3gr-elettronica-e-puls, Minimax-Kometa-Elettronica, Minimax-Replica-Elettronica, Replica-elettronica-2gr, Replica-elettronica-3gr, Replica-elettronica-4gr, Revolution-2gr-elettronica-epuls, Revolution-3gr-elettronica-epuls | | |



| | | | | |
|---|---------------------|--|-------------------|---------------|
| 1 | GEV-Nr. | 402855 | Vergl.-Nr. | ELETDOSKIMREP |
| | Beschreibung | Dosierelektronik 230V | | |
| | Für Modelle: | Chimaera, Replica-2gr-elettronica-multiboiler, Replica-3gr-elettronica-multiboiler | | |

Bild nicht vorhanden
1

| | | | |
|---------------------|--|-------------------|---------------|
| GEV-Nr. | 402856 | Vergl.-Nr. | ELETDOSPID23G |
| Beschreibung | Dosierelektronik 230V | | |
| Für Modelle: | Replica-2gr-manuale-multiboiler, Replica-3gr-manuale-multiboiler | | |

Bild nicht vorhanden
2

| | | | |
|---------------------|---------------------------------|-------------------|---------------|
| GEV-Nr. | 402869 | Vergl.-Nr. | ELETDOS3GKONE |
| Beschreibung | Dosierelektronik 3-gruppig 230V | | |
| Für Modelle: | Lollo-3gruppi | | |

1

| | | | |
|---------------------|---|-------------------|---------------|
| GEV-Nr. | 402870 | Vergl.-Nr. | ELETPUL5LED5T |
| Beschreibung | Tastatureinheit Tasten 5 | | |
| Für Modelle: | Lollo-1gruppo, Lollo-2gruppi, Lollo-3gruppi | | |

1

| | | | |
|---------------------|--|-------------------|---------------|
| GEV-Nr. | 401455 | Vergl.-Nr. | ELETPUL1LEDAL |
| Beschreibung | Tastatureinheit Tasten 5 L 116mm B 43mm mit Tasten aus Aluminium | | |
| Für Modelle: | Domobar-Super-2b-Pid-Elettronica, Domobar-Super-Elettronica, Domobar-Super-Manuale, Minimax-Kometa-Elettronica | | |

Tastaturen

Tastatureinheiten

Bild nicht vorhanden
1

| | | | |
|---------------------|--|-------------------|---------------|
| GEV-Nr. | 402861 | Vergl.-Nr. | ELETPUL1LEDNE |
| Beschreibung | Tastatureinheit | | |
| Für Modelle: | Evolution-2gr-elettronica-e-puls, Evolution-3gr-elettronica-e-puls, Revolution-2gr-elettronica-epuls, Revolution-3gr-elettronica-epuls | | |

1

| | | | |
|---------------------|--|-------------------|--------------|
| GEV-Nr. | 401457 | Vergl.-Nr. | ELEPUL1LEDKO |
| Beschreibung | Tastatureinheit Tasten 5 L 87mm B 59mm | | |

1

| | | | |
|---------------------|------------------------------|-------------------|---------------|
| GEV-Nr. | 402872 | Vergl.-Nr. | ELETPULACKORN |
| Beschreibung | Tastatureinheit Tasten 1 | | |
| Für Modelle: | Lollo-2gruppi, Lollo-3gruppi | | |

1

| | | | |
|---------------------|--|-------------------|---------------|
| GEV-Nr. | 402853 | Vergl.-Nr. | ELETPUL6T1LDT |
| Beschreibung | Tastatureinheit Tasten 6 | | |
| Für Modelle: | Cubo-2gr-Elettronico, Cubo-3gr-Elettronico, Cubo-4gr-Manuale, Minimax-Replica-Elettronica, Replica-elettronica-2gr, Replica-elettronica-3gr, Replica-elettronica-4gr | | |

Bild nicht vorhanden
1

| | | | |
|---------------------|---|-------------------|---------------|
| GEV-Nr. | 402871 | Vergl.-Nr. | ELETPUL1LED2T |
| Beschreibung | Tastatureinheit Tasten 2 | | |
| Für Modelle: | Lollo-1gruppo, Lollo-2gruppi, Lollo-3gruppi | | |

1

| | | | |
|---------------------|--|-------------------|---------------|
| GEV-Nr. | 402854 | Vergl.-Nr. | ELETPUL6T1LTD |
| Beschreibung | Tastatureinheit Tasten 6 mit LED | | |
| Für Modelle: | Replica-2gr-elettronica-multiboiler, Replica-3gr-elettronica-multiboiler | | |



Magnetventile

Magnetventile Wasser

Metall

ASCO

Ersatzteile und Zubehör



O-Ringe

| | | | |
|---|---|-------------------|--------------|
|  | | | |
| 1 | | | |
| GEV-Nr. | 371095 | Vergl.-Nr. | GUARSASTRUEV |
| Beschreibung | O-Ring Viton Materialstärke 1.78mm ID ø 6.07mm VPE 1 Stück | | |
| Für Modelle: | Evolution-2gr-elettronica-e-puls, Evolution-3gr-elettronica-e-puls, Minimax-Kometa-Elettronica, Minimax-Kometa-Pulsante, Revolution-2gr-elettronica-epuls, Revolution-3gr-elettronica-epuls | | |

PARKER

2-Wege

Serie VE-146

| | | | |
|---|--|-------------------|---------------------|
|  | | | |
| 1 | | | |
| GEV-Nr. | 370521 | Vergl.-Nr. | ELETELE2VAU22 |
| Beschreibung | Magnetventil 2-Wege 230VAC Anschluss 1/8" DN 1.5mm T.max. 370206°C Steckbuchse DIN -20° bis +130°C Serie VE-146 Spulentyp ZB09 Membrane FKM (Wasser) p max 40bar Messing | | |
| Für Modelle: | Cubo-2gr-Elettronico, Cubo-2gr-Manuale, Cubo-3gr-Elettronico, Cubo-3gr-Manuale, Cubo-4gr-Elettronico, Cubo-4gr-Manuale, Domobar-Super-Elettronica, Domobar-Super-Manuale, Minimax-Kometa-Elettronica, Minimax-Kometa-Pulsante, Minimax-Replica-Elettronica, Replica-2gr-elettronica-multiboiler, Replica-2gr-manuale-multiboiler, Replica-3gr-elettronica-multiboiler, Replica-3gr-manuale-multiboiler, Replica-elettronica-2gr, Replica-elettronica-3gr, Replica-elettronica-4gr, Replica-manuale-2gr, Replica-manuale-3gr, Replica-manuale-4gr, Replica-pulsante-2gr, Replica-pulsante-3gr, Replica-pulsante-4gr | | |
| Ersatzteile für | 370521 | | |
|  | GEV-Nr. | 371029 | Vergl.-Nr. — |
| | Magnetspule PARKER 230VAC 9VA Spulentyp ZB09 Aufnahme ø 14mm H 33mm B 34mm T 43mm | | |

| | | | |
|---|--|-------------------|--------------|
|  | | | |
| 1 | | | |
| GEV-Nr. | 370303 | Vergl.-Nr. | ELETELE2AU22 |
| Beschreibung | Magnetventil 2-Wege 230VAC Anschluss 1/8" DN 3mm Steckbuchse DIN -20° bis +130°C PARKER Serie VE-146 Spulentyp ZB09 Membrane FKM (Wasser) p max 10bar | | |
| Für Modelle: | Domobar-Junior-2B, Domobar-Junior-HX, Domobar-Super-2b-Pid-Elettronica, Domobar-Super-2b-Pid-Manuale, Domobar-Super-Elettronica, Domobar-Super-Manuale | | |

3-Wege

Serie VE-128

| | | | |
|---|---|-------------------|--------------------------------|
|  | | | |
| 1 | | | |
| GEV-Nr. | 370060 | Vergl.-Nr. | ELETELE3VCAB |
| Beschreibung | Magnetventil 3-Wege 230VAC Körper Außenkonus DN 1.2mm Steckbuchse DIN -20° bis 140°C PARKER Serie VE-128 Spulentyp YB09 mit Kabel Membrane Viton p max 10bar Messing Flansch 32x32mm | | |
| Für Modelle: | Chimaera, Cubo-2gr-Elettronico, Cubo-3gr-Elettronico, Cubo-4gr-Elettronico, Domobar-Super-2b-Pid-Elettronica, Domobar-Super-Elettronica, Evolution-2gr-elettronica-e-puls, Evolution-3gr-elettronica-e-puls, Lollo-1gruppo, Lollo-2gruppi, Lollo-3gruppi, Minimax-Kometa-Elettronica, Minimax-Kometa-Pulsante, Minimax-Replica-Elettronica, Replica-2gr-elettronica-multiboiler, Replica-3gr-elettronica-multiboiler, Replica-elettronica-2gr, Replica-elettronica-3gr, Replica-elettronica-4gr, Replica-pulsante-2gr, Replica-pulsante-3gr, Replica-pulsante-4gr, Revolution-2gr-elettronica-epuls, Revolution-3gr-elettronica-epuls | | |
| Ersatzteile für | 370060 | | |
|  | GEV-Nr. | 370062 | Vergl.-Nr. — |
| | Magnetventilkörper PARKER 3-Wege Außenkonus | | |
|  | GEV-Nr. | 371033 | Vergl.-Nr. — |
| | Magnetspule PARKER 230VAC 9VA Spulentyp YB09 mit Kabel Aufnahme ø 14mm | | |
|  | GEV-Nr. | 371095 | Vergl.-Nr. GUARSASTRUEV |
| | O-Ring Viton Materialstärke 1.78mm ID ø 6.07mm VPE 1 Stück | | |
| Zubehör für | 370060 | | |
|  | GEV-Nr. | 101527 | Vergl.-Nr. — |
| | O-Ring Viton Materialstärke 1.78mm ID ø 6.75mm VPE 1 Stück | | |
|  | GEV-Nr. | 532193 | Vergl.-Nr. — |
| | O-Ring Silikon Materialstärke 1.78mm ID ø 6.75mm VPE 10 Stück | | |

Magnetventilzubehör

| | | | |
|---|---|-------------------|--------------|
|  | | | |
| 1 | | | |
| GEV-Nr. | 371095 | Vergl.-Nr. | GUARSASTRUEV |
| Beschreibung | O-Ring Viton Materialstärke 1.78mm ID ø 6.07mm VPE 1 Stück | | |
| Für Modelle: | Evolution-2gr-elettronica-e-puls, Evolution-3gr-elettronica-e-puls, Minimax-Kometa-Elettronica, Minimax-Kometa-Pulsante, Revolution-2gr-elettronica-epuls, Revolution-3gr-elettronica-epuls | | |

Pressostate

für Kaffeetechnik

ø38mm



1

| | | | |
|---------------------|---|-------------------|---------------------|
| GEV-Nr. | 541783 | Vergl.-Nr. | ELETPREDSUKIR XP110 |
| Beschreibung | Pressostat Druckbereich 0,5-1,5bar Anschluss 1/4" 21A 250V ø 38mm voreingestellt auf 1.1bar | | |

Sonstige



1

| | | | |
|---------------------|--|-------------------|--------------|
| GEV-Nr. | 541724 | Vergl.-Nr. | ELETPREDOMSU |
| Beschreibung | Pressostat Druckbereich einstellbar 0,5-1,4bar Anschluss 1/4" 20A 3-polig Typ P303 Kaffeetechnik SIRAI | | |
| Für Modelle: | Domobar-Junior-2B, Domobar-Junior-HX, Domobar-Super-2b-Pid-Elettronica, Domobar-Super-2b-Pid-Manuale, Domobar-Super-Elettronica, Domobar-Super-Manuale | | |



1

| | | | |
|---|---|-------------------|---------------------|
| GEV-Nr. | 541021 | Vergl.-Nr. | ELETPRE |
| Beschreibung | Pressostat Druckbereich einstellbar 0,5-1,4bar Anschluss 1/4" 30A 3-polig Typ P302 Kaffeetechnik SIRAI | | |
| Für Modelle: | Chimaera, Cubo-2gr-Elettronico, Cubo-2gr-Manuale, Cubo-3gr-Elettronico, Cubo-3gr-Manuale, Cubo-4gr-Elettronico, Cubo-4gr-Manuale, Domobar-Super-2b-Pid-Elettronica, Domobar-Super-2b-Pid-Manuale, Domobar-Super-Elettronica, Domobar-Super-Manuale, Evolution-2gr-elettronica-e-puls, Evolution-3gr-elettronica-e-puls, Lollo-1gruppo, Lollo-2gruppi, Lollo-3gruppi, Minimax-Kometa-Elettronica, Minimax-Kometa-Pulsante, Minimax-Replica-Elettronica, Replica-2gr-elettronica-multiboiler, Replica-2gr-manuale-multiboiler, Replica-3gr-elettronica-multiboiler, Replica-3gr-manuale-multiboiler, Replica-elettronica-2gr, Replica-elettronica-3gr, Replica-elettronica-4gr, Replica-manuale-2gr, Replica-manuale-3gr, Replica-manuale-4gr, Replica-pulsante-2gr, Replica-pulsante-3gr, Replica-pulsante-4gr, Revolution-2gr-elettronica-epuls, Revolution-3gr-elettronica-epuls | | |
| Zubehör für | 541021 | | |
|  | GEV-Nr. | 550262 | Vergl.-Nr. — |
| | Flachdichtung Kupfer AD ø 20mm ID ø 14mm Materialstärke 2mm | | |
|  | GEV-Nr. | 890100 | Vergl.-Nr. — |
| | PTFE-Band Rolle L 12m B 12mm -200 bis +260°C Zulassung DIN-DVGW, KTW temperaturbeständig, elastisch für Feingewinde Materialstärke 0.1mm | | |

Flowmeter und Durchflusssensoren

Flowmeter

GICAR



1

| | | | |
|---------------------|---|-------------------|---------------|
| GEV-Nr. | 400775 | Vergl.-Nr. | ELETCONTVOLOT |
| Beschreibung | Flowmeter Gewinde 1/4" Messing mit LED Nenn-ø 1.15mm Steckanschluss | | |
| Für Modelle: | Chimaera, Cubo-2gr-Elettronico, Cubo-3gr-Elettronico, Domobar-Super-2b-Pid-Elettronica, Domobar-Super-2b-Pid-Manuale, Domobar-Super-Elettronica, Domobar-Super-Manuale, Evolution-2gr-elettronica-e-puls, Evolution-3gr-elettronica-e-puls, Minimax-Kometa-Elettronica, Minimax-Replica-Elettronica, Replica-2gr-elettronica-multiboiler, Replica-2gr-manuale-multiboiler, Replica-3gr-elettronica-multiboiler, Replica-3gr-manuale-multiboiler, Replica-elettronica-2gr, Replica-elettronica-3gr, Revolution-2gr-elettronica-epuls, Revolution-3gr-elettronica-epuls | | |



1

| | | | |
|---------------------|---|-------------------|---------------|
| GEV-Nr. | 541750 | Vergl.-Nr. | ELETCONTVODOS |
| Beschreibung | Flowmeter Schlauch ø 7mm Kunststoff Zulassung NSF | | |
| Für Modelle: | Domobar-Super-Elettronica, Domobar-Super-Manuale | | |



Pumpen

Drucksteigerungspumpen II

Pumpenmotoren

Schellenanschluss



| | | | |
|---|--|-------------------|----------------------------|
| GEV-Nr. | 500458 | Vergl.-Nr. | ELETMOT22V |
| Beschreibung | Pumpenmotor RPM Typ 11002778 165W 230V 50Hz Anschluss Schelle L 165mm B 130mm H 140mm Kondensator 10µF | | |
| Ersatzteile für | 500458 | | |
|  | GEV-Nr. | 365015 | Vergl.-Nr. ELETCOND |
| | Betriebskondensator Kapazität 10µF 400V Becherkondensator Toleranz 5%Hz Umgebungstemperatur max. -25 bis + 85°C ø 35,5mm L 59mm Doppelanschluss M8 Kunststoff Anschluss Flachstecker 6,3mm Schutzart | | |



| | | | |
|---|---|-------------------|--------------------------------|
| GEV-Nr. | 500452 | Vergl.-Nr. | ELETMOTRPM304 |
| Beschreibung | Pumpenmotor RPM Typ C004311 100W 230V 50/60Hz Anschluss Schelle L 160mm B 95mm H 140mm Kondensator 5µF | | |
| Für Modelle: | Chimaera, Cubo-2gr-Elettronico, Cubo-2gr-Manuale, Cubo-3gr-Elettronico, Cubo-3gr-Manuale, Cubo-4gr-Elettronico, Cubo-4gr-Manuale, Domobar-Super-2b-Pid-Elettronica, Domobar-Super-2b-Pid-Manuale, Domobar-Super-Elettronica, Domobar-Super-Manuale, Evolution-2gr-elettronica-e-puls, Evolution-3gr-elettronica-e-puls, Lollo-1gruppo, Lollo-2gruppi, Lollo-3gruppi, Minimax-Kometa-Elettronica, Minimax-Kometa-Pulsante, Minimax-Replica-Elettronica, Replica-2gr-elettronica-multiboiler, Replica-2gr-manuale-multiboiler, Replica-3gr-elettronica-multiboiler, Replica-3gr-manuale-multiboiler, Replica-elettronica-2gr, Replica-elettronica-3gr, Replica-elettronica-4gr, Replica-manuale-2gr, Replica-manuale-3gr, Replica-manuale-4gr, Replica-pulsante-2gr, Replica-pulsante-3gr, Replica-pulsante-4gr, Revolution-2gr-elettronica-epuls, Revolution-3gr-elettronica-epuls | | |
| Ersatzteile für | 500452 | | |
|  | GEV-Nr. | 365066 | Vergl.-Nr. ELETCOND RPM |
| | Betriebskondensator Kapazität 7µF 450V Becherkondensator Toleranz 5% 50/60Hz Umgebungstemperatur max. -25 bis + 85°C ø 31mm L 55mm M8 Kunststoff Anschluss Flachstecker 2,8mm Schutzart | | |

Pumpenköpfe

FLUID-O-TECH



1

| | | | |
|---------------------|---|-------------------|---------------|
| GEV-Nr. | 499088 | Vergl.-Nr. | POMPPRONOSETN |
| Beschreibung | Pumpenkopf PA074 FLUID-O-TECH L 82mm 70l/h Anschluss 3/8" GAS mit Bypass Messing Schellenanschluss Achse ø 10,8x4,8mm Zulassung NSF | | |



1

| | | | |
|---------------------|---|-------------------|-----------------------|
| GEV-Nr. | 499056 | Vergl.-Nr. | POMPPRONO UNK21572132 |
| Beschreibung | Pumpenkopf PA1504 FLUID-O-TECH L 82mm 150l/h Anschluss 3/8" GAS mit Bypass Messing Schellenanschluss für Kaffeemaschine Achse ø 10,8x4,8mm Zulassung NSF | | |
| Für Modelle: | Chimaera, Cubo-2gr-Elettronico, Cubo-2gr-Manuale, Cubo-3gr-Elettronico, Cubo-3gr-Manuale, Cubo-4gr-Elettronico, Cubo-4gr-Manuale, Evolution-2gr-elettronica-e-puls, Evolution-3gr-elettronica-e-puls, Lollo-1gruppo, Lollo-2gruppi, Lollo-3gruppi, Minimax-Kometa-Elettronica, Minimax-Kometa-Pulsante, Minimax-Replica-Elettronica, Replica-2gr-elettronica-multiboiler, Replica-2gr-manuale-multiboiler, Replica-3gr-elettronica-multiboiler, Replica-3gr-manuale-multiboiler, Replica-elettronica-2gr, Replica-elettronica-3gr, Replica-elettronica-4gr, Replica-manuale-2gr, Replica-manuale-3gr, Replica-manuale-4gr, Replica-pulsante-2gr, Replica-pulsante-3gr, Replica-pulsante-4gr, Revolution-2gr-elettronica-epuls, Revolution-3gr-elettronica-epuls | | |



1

| | | | |
|---------------------|--|-------------------|-----------|
| GEV-Nr. | 500454 | Vergl.-Nr. | POMPROCFL |
| Beschreibung | Pumpenkopf PA1504 FLUID-O-TECH L 82mm 150l/h Anschluss 3/8" NPT mit Bypass Messing Schellenanschluss für Kaffeemaschine Achse ø 4,8x11mm Zulassung NSF | | |

1 Elektrokomponenten

PROCON





1

| | | | |
|---------------------|---|-------------------|---------------|
| GEV-Nr. | 500453 | Vergl.-Nr. | POMPPRONOSETN |
| Beschreibung | Pumpenkopf T6495 PROCON L 82mm 100l/h Anschluss 3/8" NPT mit Bypass Messing Schellenanschluss für Kaffeemaschine Achse ø 4,8x11mm | | |
| Für Modelle: | Chimaera, Cubo-2gr-Elettronico, Cubo-2gr-Manuale, Cubo-3gr-Elettronico, Cubo-3gr-Manuale, Cubo-4gr-Elettronico, Cubo-4gr-Manuale, Domobar-Super-2b-Pid-Elettronica, Domobar-Super-2b-Pid-Manuale, Domobar-Super-Elettronica, Domobar-Super-Manuale, Evolution-2gr-elettronica-e-puls, Evolution-3gr-elettronica-e-puls, Lollo-1gruppo, Lollo-2gruppi, Lollo-3gruppi, Minimax-Kometa-Elettronica, Minimax-Kometa-Pulsante, Minimax-Replica-Elettronica, Replica-2gr-elettronica-multiboiler, Replica-2gr-manuale-multiboiler, Replica-3gr-elettronica-multiboiler, Replica-3gr-manuale-multiboiler, Replica-elettronica-2gr, Replica-elettronica-3gr, Replica-elettronica-4gr, Replica-manuale-2gr, Replica-manuale-3gr, Replica-manuale-4gr, Replica-pulsante-2gr, Replica-pulsante-3gr, Replica-pulsante-4gr, Revolution-2gr-elettronica-epuls, Revolution-3gr-elettronica-epuls | | |



1

| | | | |
|---------------------|---|---|------------------------|
| GEV-Nr. | 500124 | Vergl.-Nr. | POMPVIBDOM UNK46491381 |
| Beschreibung | Vibrationspumpe Typ EX5 230V 48W 50/60Hz Eingang ø 6 Ausgang ø 1/8" IG flachdichtend ULKA Messing L 123mm | | |
| Für Modelle: | Domobar-Interruttore-Levetta, Domobar-Interruttore-Luminoso, Domobar-Junior-2B, Domobar-Junior-HX, Domobar-Super-2b-Pid-Elettronica, Domobar-Super-2b-Pid-Manuale, Domobar-Super-Elettronica, Domobar-Super-Manuale | | |
| Zubehör für | 500124 | | |
| |  | GEV-Nr. 520152 | Vergl.-Nr. — |
| | | Schlauchanschluss Santoprene Tülle ø 7mm Tüllenlänge 14mm | |
| |  | GEV-Nr. 520330 | Vergl.-Nr. — |
| | | Halter Gummi Maße 69x44x4mm | |

Zubehör



1

| | | | |
|---------------------|--|-------------------|----------|
| GEV-Nr. | 365015 | Vergl.-Nr. | ELETCOND |
| Beschreibung | Betriebskondensator Kapazität 10µF 400V Becherkondensator Toleranz 5%Hz Umgebungstemperatur max. -25 bis + 85°C ø 35.5mm L 59mm Doppelanschluss M8 Kunststoff Anschluss Flachstecker 6,3mm Schutzart | | |

Kondensatoren & Entstörfilter

Betriebskondensatoren

Kunststoff



1

| | | | |
|---------------------|--|-------------------|----------|
| GEV-Nr. | 365015 | Vergl.-Nr. | ELETCOND |
| Beschreibung | Betriebskondensator Kapazität 10µF 400V Becherkondensator Toleranz 5%Hz Umgebungstemperatur max. -25 bis + 85°C ø 35.5mm L 59mm Doppelanschluss M8 Kunststoff Anschluss Flachstecker 6,3mm Schutzart | | |



1

| | | | |
|---------------------|-------------------------|-------------------|----------|
| GEV-Nr. | 500456 | Vergl.-Nr. | TUBIP415 |
| Beschreibung | Bypass für PROCON Pumpe | | |



1

| | | | |
|---------------------|---|-------------------|--------------|
| GEV-Nr. | 365066 | Vergl.-Nr. | ELETCOND RPM |
| Beschreibung | Betriebskondensator Kapazität 7µF 450V Becherkondensator Toleranz 5% 50/60Hz Umgebungstemperatur max. -25 bis + 85°C ø 31mm L 55mm M8 Kunststoff Anschluss Flachstecker 2,8mm Schutzart | | |
| Für Modelle: | Chimaera, Cubo-2gr-Elettronico, Cubo-2gr-Manuale, Cubo-3gr-Elettronico, Cubo-3gr-Manuale, Cubo-4gr-Elettronico, Cubo-4gr-Manuale, Domobar-Super-2b-Pid-Elettronica, Domobar-Super-2b-Pid-Manuale, Domobar-Super-Elettronica, Domobar-Super-Manuale, Evolution-2gr-elettronica-e-puls, Evolution-3gr-elettronica-e-puls, Lollo-1gruppo, Lollo-2gruppi, Lollo-3gruppi, Minimax-Kometa-Elettronica, Minimax-Kometa-Pulsante, Minimax-Replica-Elettronica, Replica-2gr-elettronica-multiboiler, Replica-2gr-manuale-multiboiler, Replica-3gr-elettronica-multiboiler, Replica-3gr-manuale-multiboiler, Replica-elettronica-2gr, Replica-elettronica-3gr, Replica-elettronica-4gr, Replica-manuale-2gr, Replica-manuale-3gr, Replica-manuale-4gr, Replica-pulsante-2gr, Replica-pulsante-3gr, Replica-pulsante-4gr, Revolution-2gr-elettronica-epuls, Revolution-3gr-elettronica-epuls | | |

Vibrationspumpen



1

| | | | |
|---------------------|---|-------------------|---------------|
| GEV-Nr. | 390698 | Vergl.-Nr. | TERMPROTDOMSU |
| Beschreibung | Thermosicherung Abschalttemp. 110°C passend für Ulka Pumpe | | |
| Für Modelle: | Domobar-Interruttore-Levetta, Domobar-Interruttore-Luminoso, Domobar-Junior-2B, Domobar-Junior-HX, Domobar-Super-2b-Pid-Elettronica, Domobar-Super-2b-Pid-Manuale, Domobar-Super-Elettronica, Domobar-Super-Manuale | | |

Gerätespezifische Bauteile

für Espressomaschinen

Siebträger

Siebträger Standard

Siebträger kurz



| | | | |
|---------------------|---|-------------------|--------|
| GEV-Nr. | 529232 | Vergl.-Nr. | PORTTN |
| Beschreibung | Siebträger Befestigung ø 82.5mm Auslauf 3/8" ID ø 62mm Griff M10x1,5 Keilhöhe 9.2mm Keilposition horizontal Keilzahl 2 Hebel gerade Messing verchromt | | |

Für Modelle: Chimaera, Cubo-2gr-Elettronico, Cubo-2gr-Manuale, Cubo-3gr-Elettronico, Cubo-3gr-Manuale, Cubo-4gr-Elettronico, Cubo-4gr-Manuale, Domobar-Interruttore-Levetta, Domobar-Interruttore-Luminoso, Domobar-Junior-2B, Domobar-Junior-HX, Domobar-Super-2b-Pid-Elettronica, Domobar-Super-2b-Pid-Manuale, Domobar-Super-Elettronica, Domobar-Super-Manuale, Evolution-2gr-elettronica-e-puls, Evolution-3gr-elettronica-e-puls, Lollo-1gruppo, Lollo-2gruppi, Lollo-3gruppi, Minimax-Kometa-Elettronica, Minimax-Kometa-Pulsante, Minimax-Replica-Elettronica, Replica-2gr-elettronica-multiboiler, Replica-2gr-manuale-multiboiler, Replica-3gr-elettronica-multiboiler, Replica-3gr-manuale-multiboiler, Replica-elettronica-2gr, Replica-elettronica-3gr, Replica-elettronica-4gr, Replica-manuale-2gr, Replica-manuale-3gr, Replica-manuale-4gr, Replica-pulsante-2gr, Replica-pulsante-3gr, Replica-pulsante-4gr, Revolution-2gr-elettronica-epuls, Revolution-3gr-elettronica-epuls

| | | | | | |
|--------------------|--------|----------------|--------|-------------------|---|
| Zubehör für | 529232 | GEV-Nr. | 529233 | Vergl.-Nr. | PORTIMPPF |
| | | | | | Griff ø 30mm Gewinde M10x1,5 L1 115mm schwarz |

Griffe

mit Außengewinde



| | | | |
|---------------------|---|-------------------|-----------|
| GEV-Nr. | 529233 | Vergl.-Nr. | PORTIMPPF |
| Beschreibung | Griff ø 30mm Gewinde M10x1,5 L1 115mm schwarz | | |



| | | | |
|---------------------|---|-------------------|--------------|
| GEV-Nr. | 525203 | Vergl.-Nr. | PORTIMPPFNEW |
| Beschreibung | Griff ø 35mm Gewinde M10x1,5 Gewinde L 14mm L 126mm schwarz | | |

Für Modelle: Chimaera, Cubo-2gr-Elettronico, Cubo-2gr-Manuale, Cubo-3gr-Elettronico, Cubo-3gr-Manuale, Cubo-4gr-Elettronico, Cubo-4gr-Manuale, Domobar-Interruttore-Levetta, Domobar-Interruttore-Luminoso, Domobar-Junior-2B, Domobar-Junior-HX, Domobar-Super-2b-Pid-Elettronica, Domobar-Super-2b-Pid-Manuale, Domobar-Super-Elettronica, Domobar-Super-Manuale, Evolution-2gr-elettronica-e-puls, Evolution-3gr-elettronica-e-puls, Lollo-1gruppo, Lollo-2gruppi, Lollo-3gruppi, Minimax-Kometa-Elettronica, Minimax-Kometa-Pulsante, Minimax-Replica-Elettronica, Replica-2gr-elettronica-multiboiler, Replica-2gr-manuale-multiboiler, Replica-3gr-elettronica-multiboiler, Replica-3gr-manuale-multiboiler, Replica-elettronica-2gr, Replica-elettronica-3gr, Replica-elettronica-4gr, Replica-manuale-2gr, Replica-manuale-3gr, Replica-manuale-4gr, Replica-pulsante-2gr, Replica-pulsante-3gr, Replica-pulsante-4gr, Revolution-2gr-elettronica-epuls, Revolution-3gr-elettronica-epuls

Ausläufe

mit Gewinde 3/8"



| | | | |
|---------------------|--|-------------------|--------------|
| GEV-Nr. | 529005 | Vergl.-Nr. | FILTBEC1TDOM |
| Beschreibung | Siebträgerauslauf Gewinde 3/8" 1 Weg gebogen/kurz Auslaufabstandmm | | |



| | | | |
|---------------------|---|-------------------|--------------|
| GEV-Nr. | 529008 | Vergl.-Nr. | FILTBEC2TDOM |
| Beschreibung | Siebträgerauslauf Gewinde 3/8" 2 Wege gebogen Auslaufabstand 33mm | | |

Siebe

für 1 Tasse



| | | | |
|---------------------|--|-------------------|---------|
| GEV-Nr. | 529011 | Vergl.-Nr. | FILT1TA |
| Beschreibung | Kaffeeseib ø 70mm Einbau ø 60mm H 24.5mm Tassen 1 Kaffeemenge 7g Lochung ø 0.4mm | | |

Für Modelle: Chimaera, Cubo-2gr-Elettronico, Cubo-2gr-Manuale, Cubo-3gr-Elettronico, Cubo-3gr-Manuale, Cubo-4gr-Elettronico, Cubo-4gr-Manuale, Domobar-Interruttore-Levetta, Domobar-Interruttore-Luminoso, Domobar-Junior-2B, Domobar-Junior-HX, Domobar-Super-2b-Pid-Elettronica, Domobar-Super-2b-Pid-Manuale, Domobar-Super-Elettronica, Domobar-Super-Manuale, Evolution-2gr-elettronica-e-puls, Evolution-3gr-elettronica-e-puls, Lollo-1gruppo, Lollo-2gruppi, Lollo-3gruppi, Minimax-Kometa-Elettronica, Minimax-Kometa-Pulsante, Minimax-Replica-Elettronica, Replica-2gr-elettronica-multiboiler, Replica-2gr-manuale-multiboiler, Replica-3gr-elettronica-multiboiler, Replica-3gr-manuale-multiboiler, Replica-elettronica-2gr, Replica-elettronica-3gr, Replica-elettronica-4gr, Replica-manuale-2gr, Replica-manuale-3gr, Replica-manuale-4gr, Replica-pulsante-2gr, Replica-pulsante-3gr, Replica-pulsante-4gr, Revolution-2gr-elettronica-epuls, Revolution-3gr-elettronica-epuls

| für 2 Tassen | | | |
|---|--|-------------------|---------|
|  | | | |
| 1 | | | |
| GEV-Nr. | 529013 | Vergl.-Nr. | FILT2TA |
| Beschreibung | Kaffeeseib ø 70mm Einbau ø 60,5mm H 25,5mm Tassen 2 Kaffeemenge 14g Lochung ø 0,3x0,3mm quadratisch | | |
| Für Modelle: | Chimaera, Cubo-2gr-Elettronico, Cubo-2gr-Manuale, Cubo-3gr-Elettronico, Cubo-3gr-Manuale, Cubo-4gr-Elettronico, Cubo-4gr-Manuale, Domobar-Interruttore-Levetta, Domobar-Interruttore-Luminoso, Domobar-Junior-2B, Domobar-Junior-HX, Domobar-Super-2b-Pid-Elettronica, Domobar-Super-2b-Pid-Manuale, Domobar-Super-Elettronica, Domobar-Super-Manuale, Evolution-2gr-elettronica-e-puls, Evolution-3gr-elettronica-e-puls, Lollo-1gruppo, Lollo-2gruppi, Lollo-3gruppi, Minimax-Kometa-Elettronica, Minimax-Kometa-Pulsante, Minimax-Replica-Elettronica, Replica-2gr-elettronica-multiboiler, Replica-2gr-manuale-multiboiler, Replica-3gr-elettronica-multiboiler, Replica-3gr-manuale-multiboiler, Replica-elettronica-2gr, Replica-elettronica-3gr, Replica-elettronica-4gr, Replica-manuale-2gr, Replica-manuale-3gr, Replica-manuale-4gr, Replica-pulsante-2gr, Replica-pulsante-3gr, Replica-pulsante-4gr, Revolution-2gr-elettronica-epuls, Revolution-3gr-elettronica-epuls | | |

| Siebträgerfedern | | | |
|---|--|-------------------|-----|
|  | | | |
| 1 | | | |
| GEV-Nr. | 531243 | Vergl.-Nr. | N/A |
| Beschreibung | Siebträgerfeder L 70mm B 60mm Drahtstärke ø 1.3mm für Espresso-Siebträger VPE 20 Stück | | |

| Brühgruppen | | | |
|---|--|-------------------|------------|
| Duschensiebe | | | |
| mit Aufkantung | | | |
|  | | | |
| 1 | | | |
| GEV-Nr. | 528417 | Vergl.-Nr. | FILTDCREGR |
| Beschreibung | Duschensieb ø 58mm H 19mm | | |
| Für Modelle: | Chimaera, Cubo-2gr-Elettronico, Cubo-2gr-Manuale, Cubo-3gr-Elettronico, Cubo-3gr-Manuale, Cubo-4gr-Elettronico, Cubo-4gr-Manuale, Domobar-Interruttore-Levetta, Domobar-Interruttore-Luminoso, Domobar-Junior-2B, Domobar-Junior-HX, Domobar-Super-2b-Pid-Elettronica, Domobar-Super-2b-Pid-Manuale, Domobar-Super-Elettronica, Domobar-Super-Manuale, Evolution-2gr-elettronica-e-puls, Evolution-3gr-elettronica-e-puls, Lollo-1gruppo, Lollo-2gruppi, Lollo-3gruppi, Minimax-Kometa-Elettronica, Minimax-Kometa-Pulsante, Minimax-Replica-Elettronica, Replica-2gr-elettronica-multiboiler, Replica-2gr-manuale-multiboiler, Replica-3gr-elettronica-multiboiler, Replica-3gr-manuale-multiboiler, Replica-elettronica-2gr, Replica-elettronica-3gr, Replica-elettronica-4gr, Replica-manuale-2gr, Replica-manuale-3gr, Replica-manuale-4gr, Replica-pulsante-2gr, Replica-pulsante-3gr, Replica-pulsante-4gr, Revolution-2gr-elettronica-epuls, Revolution-3gr-elettronica-epuls | | |

| Siebträgerdichtungen | | | |
|--|--|-------------------|---------|
| flach | | | |
| Standard | | | |
|  | | | |
| 1 | | | |
| GEV-Nr. | 526254 | Vergl.-Nr. | GUARSOT |
| Beschreibung | Siebträgerdichtung D1 ø 73,6mm D2 ø 58mm H 8mm VPE 1 Stück | | |
| Für Modelle: | Chimaera, Cubo-2gr-Elettronico, Cubo-2gr-Manuale, Cubo-3gr-Elettronico, Cubo-3gr-Manuale, Cubo-4gr-Elettronico, Cubo-4gr-Manuale, Domobar-Interruttore-Levetta, Domobar-Interruttore-Luminoso, Domobar-Junior-2B, Domobar-Junior-HX, Domobar-Super-2b-Pid-Elettronica, Domobar-Super-2b-Pid-Manuale, Domobar-Super-Elettronica, Domobar-Super-Manuale, Evolution-2gr-elettronica-e-puls, Evolution-3gr-elettronica-e-puls, Lollo-1gruppo, Lollo-2gruppi, Lollo-3gruppi, Minimax-Kometa-Elettronica, Minimax-Kometa-Pulsante, Minimax-Replica-Elettronica, Replica-2gr-elettronica-multiboiler, Replica-2gr-manuale-multiboiler, Replica-3gr-elettronica-multiboiler, Replica-3gr-manuale-multiboiler, Replica-elettronica-2gr, Replica-elettronica-3gr, Replica-elettronica-4gr, Replica-manuale-2gr, Replica-manuale-3gr, Replica-manuale-4gr, Replica-pulsante-2gr, Replica-pulsante-3gr, Replica-pulsante-4gr, Revolution-2gr-elettronica-epuls, Revolution-3gr-elettronica-epuls | | |

| Brühgruppen mit Magnetventil | | | |
|--|---|-------------------|------------|
| Einzelteile | | | |
|  | | | |
| 1 | | | |
| GEV-Nr. | 525170 | Vergl.-Nr. | ASSTASCAUT |
| Beschreibung | Ablaufrohr 1/8" L 42mm SW 22 | | |
| Für Modelle: | Chimaera, Cubo-2gr-Elettronico, Cubo-3gr-Elettronico, Cubo-4gr-Elettronico, Domobar-Super-2b-Pid-Elettronica, Domobar-Super-Elettronica, Minimax-Replica-Elettronica, Replica-2gr-elettronica-multiboiler, Replica-3gr-elettronica-multiboiler, Replica-elettronica-2gr, Replica-elettronica-3gr, Replica-elettronica-4gr, Replica-pulsante-2gr, Replica-pulsante-3gr, Replica-pulsante-4gr, Revolution-2gr-elettronica-epuls, Revolution-3gr-elettronica-epuls | | |

| | | | |
|--|--------------------------|-------------------|---------------|
|  | | | |
| 1 | | | |
| GEV-Nr. | 528959 | Vergl.-Nr. | RACCTASC28AUT |
| Beschreibung | Schraube G1: 1/4" L 28mm | | |

Brühgruppen manuell

Einzelteile

Buchsen



| | | | |
|---------------------|---|-------------------|------------|
| GEV-Nr. | 525177 | Vergl.-Nr. | RACCBUPRGO |
| Beschreibung | Buchse D1 ø 15mm D2 ø 10mm ID ø 8mm H 28mm Messing | | |
| Für Modelle: | Cubo-2gr-Manuale, Cubo-3gr-Manuale, Cubo-4gr-Manuale, Domobar-Interruttore-Levetta, Domobar-Interruttore-Luminoso, Domobar-Junior-2B, Domobar-Junior-HX, Domobar-Super-2b-Pid-Manuale, Domobar-Super-Manuale, Replica-2gr-manuale-multiboiler, Replica-3gr-manuale-multiboiler, Replica-manuale-2gr, Replica-manuale-3gr, Replica-manuale-4gr | | |

Dichtungen



| | | | |
|---------------------|---|-------------------|--------|
| GEV-Nr. | 529795 | Vergl.-Nr. | GUARPI |
| Beschreibung | Dichtung D1 ø 13mm D2 ø 4mm Materialstärke 4mm Kaffeemaschine | | |
| Für Modelle: | Chimaera, Cubo-2gr-Elettronico, Cubo-2gr-Manuale, Cubo-3gr-Elettronico, Cubo-3gr-Manuale, Cubo-4gr-Elettronico, Cubo-4gr-Manuale, Minimax-Replica-Elettronica, Replica-2gr-elettronica-multiboiler, Replica-2gr-manuale-multiboiler, Replica-3gr-elettronica-multiboiler, Replica-3gr-manuale-multiboiler, Replica-elettronica-2gr, Replica-elettronica-3gr, Replica-elettronica-4gr, Replica-manuale-2gr, Replica-manuale-3gr, Replica-manuale-4gr | | |

Federn



| | | | |
|---------------------|---|-------------------|----------|
| GEV-Nr. | 527934 | Vergl.-Nr. | MOLLVAER |
| Beschreibung | Druckfeder ø 14.2mm L 45mm Drahtstärke ø 1.5mm CNS | | |
| Für Modelle: | Cubo-2gr-Manuale, Cubo-3gr-Manuale, Cubo-4gr-Manuale, Domobar-Interruttore-Levetta, Domobar-Interruttore-Luminoso, Domobar-Junior-2B, Domobar-Junior-HX, Domobar-Super-2b-Pid-Manuale, Domobar-Super-Manuale, Replica-2gr-manuale-multiboiler, Replica-3gr-manuale-multiboiler, Replica-manuale-2gr, Replica-manuale-3gr, Replica-manuale-4gr | | |



Nockenwellen



| | | | |
|---------------------|---|-------------------|------------|
| GEV-Nr. | 525171 | Vergl.-Nr. | RACCALCAGR |
| Beschreibung | Nockenwelle Welle ø 8mm Achsaufnahme ø 6.2mm L 86.5mm B 20mm H 17mm Gewinde M6 Messing verchromt | | |
| Für Modelle: | Cubo-2gr-Manuale, Cubo-3gr-Manuale, Cubo-4gr-Manuale, Domobar-Interruttore-Levetta, Domobar-Interruttore-Luminoso, Domobar-Junior-2B, Domobar-Junior-HX, Domobar-Super-2b-Pid-Manuale, Domobar-Super-Manuale, Replica-2gr-manuale-multiboiler, Replica-3gr-manuale-multiboiler, Replica-manuale-2gr, Replica-manuale-3gr, Replica-manuale-4gr | | |

Ventile



| | | | | |
|---|---|-------------------|-------------------|---|
| GEV-Nr. | 526008 | Vergl.-Nr. | ASSVALVEROG | |
| Beschreibung | Ventil Gruppe Ablauf L 54.3mm AD ø 16mm Achse ø 4.5mm Messing | | | |
| Für Modelle: | Cubo-2gr-Manuale, Cubo-3gr-Manuale, Cubo-4gr-Manuale, Domobar-Interruttore-Levetta, Domobar-Interruttore-Luminoso, Domobar-Junior-2B, Domobar-Junior-HX, Domobar-Super-2b-Pid-Manuale, Domobar-Super-Manuale, Replica-2gr-manuale-multiboiler, Replica-3gr-manuale-multiboiler, Replica-manuale-2gr, Replica-manuale-3gr, Replica-manuale-4gr | | | |
| Zubehör für | 526008 | | | |
| | GEV-Nr. | 526003 | Vergl.-Nr. | — |
|  | Druckfeder ø 13.8mm L 54.5mm Drahtstärke ø 1.5mm Windungen 10 Ablaufventil | | | |
| | GEV-Nr. | 532550 | Vergl.-Nr. | — |
|  | O-Ring NBR 787/70 Materialstärke 2.62mm ID ø 9.13mm VPE 10 Stück | | | |



| | | | |
|---------------------|--|-------------------|-------------|
| GEV-Nr. | 525180 | Vergl.-Nr. | ASSVALVSCAR |
| Beschreibung | Ventil L 27mm AD ø 16mm Achse dreieckig Messing | | |
| Für Modelle: | Cubo-2gr-Elettronico, Cubo-2gr-Manuale, Cubo-3gr-Elettronico, Cubo-3gr-Manuale, Cubo-4gr-Elettronico, Cubo-4gr-Manuale, Domobar-Interruttore-Levetta, Domobar-Interruttore-Luminoso, Domobar-Junior-2B, Domobar-Junior-HX, Domobar-Super-2b-Pid-Manuale, Domobar-Super-Manuale, Minimax-Kometa-Elettronica, Minimax-Kometa-Pulsante, Minimax-Replica-Elettronica, Replica-2gr-manuale-multiboiler, Replica-3gr-manuale-multiboiler, Replica-elettronica-2gr, Replica-elettronica-3gr, Replica-elettronica-4gr, Replica-manuale-2gr, Replica-manuale-3gr, Replica-manuale-4gr, Replica-pulsante-2gr, Replica-pulsante-3gr, Replica-pulsante-4gr | | |





| | | | |
|---------------------|---|-------------------|------------|
| GEV-Nr. | 525181 | Vergl.-Nr. | ASSVALVINF |
| Beschreibung | Ventil L 61mm AD ø 16mm Achse dreieckig Messing | | |
| Für Modelle: | Cubo-2gr-Manuale, Cubo-3gr-Manuale, Cubo-4gr-Manuale, Domobar-Interruttore-Levetta, Domobar-Interruttore-Luminoso, Domobar-Junior-2B, Domobar-Junior-HX, Domobar-Super-2b-Pid-Manuale, Domobar-Super-Manuale, Replica-2gr-manuale-multiboiler, Replica-3gr-manuale-multiboiler, Replica-manuale-2gr, Replica-manuale-3gr, Replica-manuale-4gr | | |

Verschraubungen



| | | | |
|---------------------|---|-------------------|------------|
| GEV-Nr. | 527942 | Vergl.-Nr. | RACCTAPRGO |
| Beschreibung | Verschraubung Gewinde 1/2" Innen-ø 1 10.8mm Innen-ø 2 15mm L 17mm SW 22 | | |
| Für Modelle: | Cubo-2gr-Manuale, Cubo-3gr-Manuale, Cubo-4gr-Manuale, Domobar-Interruttore-Levetta, Domobar-Interruttore-Luminoso, Domobar-Junior-2B, Domobar-Junior-HX, Domobar-Super-2b-Pid-Manuale, Domobar-Super-Manuale, Replica-2gr-manuale-multiboiler, Replica-3gr-manuale-multiboiler, Replica-manuale-2gr, Replica-manuale-3gr, Replica-manuale-4gr | | |

| Einzelteile | | | |
|---|--|------------|-----------|
| Düsen | | | |
| mit Gewinde | | | |
|  | | | |
| 1 | | | |
| GEV-Nr. | 528486 | Vergl.-Nr. | RACCGIES7 |
| Beschreibung | Düse Bohrung ø 0.7mm Gewinde M6x0,75 L 9mm SW 7 | | |
| Für Modelle: | Chimaera, Cubo-2gr-Elettronico, Cubo-2gr-Manuale, Cubo-3gr-Elettronico, Cubo-3gr-Manuale, Cubo-4gr-Elettronico, Cubo-4gr-Manuale, Domobar-Interruttore-Levetta, Domobar-Interruttore-Luminoso, Domobar-Junior-2B, Domobar-Junior-HX, Domobar-Super-2b-Pid-Elettronica, Domobar-Super-2b-Pid-Manuale, Domobar-Super-Elettronica, Domobar-Super-Manuale, Evolution-2gr-elettronica-e-puls, Evolution-3gr-elettronica-e-puls, Lollo-1gruppo, Lollo-2gruppi, Lollo-3gruppi, Minimax-Kometa-Elettronica, Minimax-Kometa-Pulsante, Minimax-Replica-Elettronica, Replica-2gr-elettronica-multiboiler, Replica-2gr-manuale-multiboiler, Replica-3gr-elettronica-multiboiler, Replica-3gr-manuale-multiboiler, Replica-elettronica-2gr, Replica-elettronica-3gr, Replica-elettronica-4gr, Replica-manuale-2gr, Replica-manuale-3gr, Replica-manuale-4gr, Replica-pulsante-2gr, Replica-pulsante-3gr, Replica-pulsante-4gr, Revolution-2gr-elettronica-epuls, Revolution-3gr-elettronica-epuls | | |

| Federn | | | |
|--|---|------------|----------|
|  | | | |
| 1 | | | |
| GEV-Nr. | 526561 | Vergl.-Nr. | MOLLPRGO |
| Beschreibung | Druckfeder ø 14.3mm L 21mm Drahtstärke ø 1.8mm | | |
| Für Modelle: | Cubo-2gr-Manuale, Cubo-3gr-Manuale, Cubo-4gr-Manuale, Domobar-Interruttore-Levetta, Domobar-Interruttore-Luminoso, Domobar-Junior-2B, Domobar-Junior-HX, Domobar-Super-2b-Pid-Manuale, Domobar-Super-Manuale, Replica-2gr-manuale-multiboiler, Replica-3gr-manuale-multiboiler, Replica-manuale-2gr, Replica-manuale-3gr, Replica-manuale-4gr | | |

| Schrauben | | | |
|---|---|------------|-----------|
|  | | | |
| 1 | | | |
| GEV-Nr. | 560373 | Vergl.-Nr. | VITEVITBR |
| Beschreibung | Zylinderkopfschraube Gewinde M4 Gewinde L 12mm SW 3 CNS VPE 1 Stück Aufnahme Innensechskant DIN 912/ISO 4762 | | |
| Für Modelle: | Chimaera, Cubo-2gr-Elettronico, Cubo-3gr-Elettronico, Cubo-4gr-Elettronico, Domobar-Super-2b-Pid-Elettronica, Domobar-Super-Elettronica, Evolution-2gr-elettronica-e-puls, Evolution-3gr-elettronica-e-puls, Lollo-1gruppo, Lollo-2gruppi, Lollo-3gruppi, Minimax-Kometa-Elettronica, Minimax-Kometa-Pulsante, Minimax-Replica-Elettronica, Replica-2gr-elettronica-multiboiler, Replica-3gr-elettronica-multiboiler, Replica-elettronica-2gr, Replica-elettronica-3gr, Replica-elettronica-4gr, Replica-pulsante-2gr, Replica-pulsante-3gr, Replica-pulsante-4gr, Revolution-2gr-elettronica-epuls, Revolution-3gr-elettronica-epuls | | |

| Wasserverteiler | | | |
|--|--|------------|------------|
| Wasserverteiler | | | |
| Gruppe 2 | | | |
|  | | | |
| 1 | | | |
| GEV-Nr. | 525169 | Vergl.-Nr. | RACCSPGRKO |
| Beschreibung | Wasserverteiler ø 21mm Loch ø 1.5mm H 12mm AG M6 Kerben 6 Kerbenbreite 1.3mm Messing 2 Löcher Lochung ø 1.7mm | | |
| Für Modelle: | Evolution-2gr-elettronica-e-puls, Evolution-3gr-elettronica-e-puls, Lollo-1gruppo, Lollo-2gruppi, Lollo-3gruppi, Minimax-Kometa-Elettronica, Minimax-Kometa-Pulsante | | |

|  | | | |
|---|--|------------|----------|
| 1 | | | |
| GEV-Nr. | 529081 | Vergl.-Nr. | RACCSPGR |
| Beschreibung | Wasserverteiler ø 30mm Loch ø 1.5mm H 15mm AG M10x1 Kerben 6 Kerbenbreite 2.5mm Messing | | |
| Für Modelle: | Chimaera, Cubo-2gr-Elettronico, Cubo-2gr-Manuale, Cubo-3gr-Elettronico, Cubo-3gr-Manuale, Cubo-4gr-Elettronico, Cubo-4gr-Manuale, Domobar-Interruttore-Levetta, Domobar-Interruttore-Luminoso, Domobar-Junior-2B, Domobar-Junior-HX, Domobar-Super-2b-Pid-Elettronica, Domobar-Super-2b-Pid-Manuale, Domobar-Super-Elettronica, Domobar-Super-Manuale, Minimax-Replica-Elettronica, Replica-2gr-elettronica-multiboiler, Replica-2gr-manuale-multiboiler, Replica-3gr-elettronica-multiboiler, Replica-3gr-manuale-multiboiler, Replica-elettronica-2gr, Replica-elettronica-3gr, Replica-elettronica-4gr, Replica-manuale-2gr, Replica-manuale-3gr, Replica-manuale-4gr, Replica-pulsante-2gr, Replica-pulsante-3gr, Replica-pulsante-4gr, Revolution-2gr-elettronica-epuls, Revolution-3gr-elettronica-epuls | | |

| Sicherheitsventile | | | |
|---|---|------------|--------|
| Sicherheitsventile | | | |
| 1/2" | | | |
|  | | | |
| 1 | | | |
| GEV-Nr. | 529306 | Vergl.-Nr. | VALVMO |
| Beschreibung | Sicherheitsventil Anschluss 1/2" Auslösedruck 1.8bar | | |
| Für Modelle: | Chimaera, Evolution-2gr-elettronica-e-puls, Evolution-3gr-elettronica-e-puls, Lollo-2gruppi, Lollo-3gruppi, Minimax-Kometa-Elettronica, Minimax-Kometa-Pulsante, Replica-2gr-elettronica-multiboiler, Replica-2gr-manuale-multiboiler, Replica-3gr-elettronica-multiboiler, Replica-3gr-manuale-multiboiler, Revolution-2gr-elettronica-epuls, Revolution-3gr-elettronica-epuls | | |

Expansionsventile

mit Schlauchanschluss



| | | | |
|---------------------|---|-------------------|---------------|
| GEV-Nr. | 526587 | Vergl.-Nr. | ASSVALVESPEVO |
| Beschreibung | Expansionsventil G1: 1/4" AG Schlauch ø 9.5mm L 42mm | | |
| Für Modelle: | Chimaera, Evolution-2gr-elettronica-e-puls, Evolution-3gr-elettronica-e-puls, Lollo-1gruppo, Lollo-2gruppi, Lollo-3gruppi, Replica-2gr-elettronica-multiboiler, Replica-2gr-manuale-multiboiler, Replica-3gr-elettronica-multiboiler, Replica-3gr-manuale-multiboiler, Revolution-2gr-elettronica-epuls, Revolution-3gr-elettronica-epuls | | |

Dichtungen



| | | | |
|---------------------|---|-------------------|----------------|
| GEV-Nr. | 525182 | Vergl.-Nr. | GUARSILRUDOMSU |
| Beschreibung | Dichtscheibe ø 9mm Materialstärke 5mm Silikon VPE 1 Stück | | |
| Für Modelle: | Domobar-Super-Elettronica, Domobar-Super-Manuale | | |



| | | | |
|---------------------|--|-------------------|---------------|
| GEV-Nr. | 698775 | Vergl.-Nr. | GUARSILRUDOST |
| Beschreibung | Dichtung AD ø 9.5mm H 5mm PTFE für Espressomaschine | | |
| Für Modelle: | Domobar-Junior-2B, Domobar-Junior-HX, Domobar-Super-2b-Pid-Elettronica, Domobar-Super-2b-Pid-Manuale, Domobar-Super-Elettronica, Domobar-Super-Manuale | | |

Druckfedern



| | | | |
|---------------------|--|-------------------|---|
| GEV-Nr. | 526474 | Vergl.-Nr. | MOLLCOVANORIT MOLLCOVATNORIT UNK1479865 |
| Beschreibung | Druckfeder ø 8mm L 31.5mm Drahtstärke ø 0.4mm für Expansionsventil | | |
| Für Modelle: | Cubo-2gr-Elettronico, Cubo-2gr-Manuale, Cubo-3gr-Elettronico, Cubo-3gr-Manuale, Cubo-4gr-Elettronico, Cubo-4gr-Manuale, Minimax-Kometa-Elettronica, Minimax-Kometa-Pulsante, Minimax-Replica-Elettronica, Replica-elettronica-2gr, Replica-elettronica-3gr, Replica-elettronica-4gr, Replica-manuale-2gr, Replica-manuale-3gr, Replica-manuale-4gr, Replica-pulsante-2gr, Replica-pulsante-3gr, Replica-pulsante-4gr | | |

Ablaufwannen

Ablaufwannen



| | | | |
|---------------------|---|-------------------|---------------|
| GEV-Nr. | 525168 | Vergl.-Nr. | MATECSCSCEVOL |
| Beschreibung | Ablaufwanne ø 76mm H 36mm Loch ø 12mm Schlauch ø 18mm | | |
| Für Modelle: | Evolution-2gr-elettronica-e-puls, Evolution-3gr-elettronica-e-puls, Lollo-1gruppo, Lollo-2gruppi, Lollo-3gruppi, Replica-2gr-elettronica-multiboiler, Replica-2gr-manuale-multiboiler, Replica-3gr-elettronica-multiboiler, Replica-3gr-manuale-multiboiler, Revolution-2gr-elettronica-epuls, Revolution-3gr-elettronica-epuls | | |



| | | | |
|---------------------|--|-------------------|-----------|
| GEV-Nr. | 531083 | Vergl.-Nr. | MATECSCSC |
| Beschreibung | Ablaufwanne ø 76mm H 36mm Schlauch ø 18mm | | |
| Für Modelle: | Minimax-Kometa-Elettronica, Minimax-Kometa-Pulsante, Minimax-Replica-Elettronica, Replica-elettronica-2gr, Replica-elettronica-3gr, Replica-elettronica-4gr, Replica-manuale-2gr, Replica-manuale-3gr, Replica-manuale-4gr, Replica-pulsante-2gr, Replica-pulsante-3gr, Replica-pulsante-4gr | | |

Boiler

Dichtungen

ungelocht



| | | | |
|---------------------|---|-------------------|-----|
| GEV-Nr. | 528137 | Vergl.-Nr. | N/A |
| Beschreibung | Boilerdichtung D1 ø 163mm D2 ø 150mm Materialstärke 4mm PTFE passend für VIBIEMME | | |

Dampf-/Wasserhähne

Dampf-/Wasserhähne

Dampf-/Wasserhähne



1

| | | | |
|---------------------|---|-------------------|---------------|
| GEV-Nr. | 531260 | Vergl.-Nr. | RACCRUBVAACEV |
| Beschreibung | Dampf-/Wasserhahn Eingang 1/4" Ausgang 3/8" Achse ø6mm Achslänge 15mm Messing | | |



1

| | | | |
|---------------------|---|-------------------|-----|
| GEV-Nr. | 529560 | Vergl.-Nr. | N/A |
| Beschreibung | Dampf-/Wasserhahn Eingang 1/4" Ausgang 3/8" passend für MERCURY | | |



1

| | | | |
|---------------------|---|-------------------|--|
| GEV-Nr. | 525191 | Vergl.-Nr. | ASSRACCRUBLOLLO+RACCDAFISSRLO RACCRUBVAKRIN UNK1660283 |
| Beschreibung | Dampf-/Wasserhahn EP links/rechts Eingang 3/8" Ausgang 3/8" Achse M8 Achslänge 25mm Messing verchromt | | |
| Für Modelle: | Lollo-1gruppo, Lollo-2gruppi, Lollo-3gruppi | | |

Dampfhähne

Dampfhähne komplett



1

| | | | |
|---------------------|---|-------------------|---------------|
| GEV-Nr. | 525187 | Vergl.-Nr. | RACCRUBVAKNEW |
| Beschreibung | Dampfhahn Eingang 1/4" Rohrlänge 150mm Rohr ø 8mm | | |
| Für Modelle: | Evolution-2gr-elettronica-e-puls, Evolution-3gr-elettronica-e-puls, Minimax-Kometa-Elettronica, Minimax-Kometa-Pulsante, Revolution-2gr-elettronica-epuls, Revolution-3gr-elettronica-epuls | | |



1

| | | | |
|---------------------|--|-------------------|------------------------------|
| GEV-Nr. | 525186 | Vergl.-Nr. | RACCRUBVASXKN UNK24830165 |
| Beschreibung | Dampfhahn EP links Eingang 3/8" Messing verchromt Rohrlänge 250mm Rohr ø 8mm | | |
| Für Modelle: | Lollo-1gruppo, Lollo-2gruppi, Lollo-3gruppi | | |



1

| | | | |
|---------------------|---|-------------------|---|
| GEV-Nr. | 525185 | Vergl.-Nr. | ASSRACCRUBLOLLO+TUBIVALFDKONW RACCRUBVADXKN UNK54712463 |
| Beschreibung | Dampfhahn EP rechts mit Dampfrohr Eingang 3/8" Messing verchromt Rohrlänge 250mm Rohr ø 8mm | | |
| Für Modelle: | Lollo-1gruppo, Lollo-2gruppi, Lollo-3gruppi | | |



1

| | | | | |
|------------------------|--|-------------------|-------------------------------|--------------------------|
| GEV-Nr. | 529891 | Vergl.-Nr. | RACCRUBVAMEIN RACCRUBVAMER | |
| Beschreibung | Dampfhahn mit Dampfrohr | | | |
| Für Modelle: | Replica-pulsante-2gr, Replica-pulsante-3gr, Replica-pulsante-4gr | | | |
| Ersatzteile für | 529891 | | | |
| | GEV-Nr. | 529893 | Vergl.-Nr. | TUBIVALF TUBIVALFINOX |
| | Dampfrohr IG 3/8" | | | |

Körper



| | | | |
|---------------------|---|-------------------|---------------------------|
| GEV-Nr. | 525198 | Vergl.-Nr. | RACCCORUVA UNK83890755 |
| Beschreibung | Hahnkörper G1: 3/8" G2: 1/2" L 76mm | | |
| Für Modelle: | Chimaera, Cubo-2gr-Elettronico, Cubo-2gr-Manuale, Cubo-3gr-Elettronico, Cubo-3gr-Manuale, Cubo-4gr-Elettronico, Cubo-4gr-Manuale, Minimax-Replica-Elettronica, Replica-2gr-elettronica-multiboiler, Replica-2gr-manuale-multiboiler, Replica-3gr-elettronica-multiboiler, Replica-3gr-manuale-multiboiler, Replica-elettronica-2gr, Replica-elettronica-3gr, Replica-elettronica-4gr, Replica-manuale-2gr, Replica-manuale-3gr, Replica-manuale-4gr | | |

Einzelteile

Achsen



| | | | |
|---------------------|---|-------------------|---------------|
| GEV-Nr. | 525173 | Vergl.-Nr. | RACCASTRUBEVO |
| Beschreibung | Achse ø 6mm D2 ø 14.5mm L 100mm Messing | | |
| Für Modelle: | Evolution-2gr-elettronica-e-puls, Evolution-3gr-elettronica-e-puls, Minimax-Kometa-Elettronica, Minimax-Kometa-Pulsante, Revolution-2gr-elettronica-epuls, Revolution-3gr-elettronica-epuls | | |



| | | | |
|---------------------|---|-------------------|----------------------------|
| GEV-Nr. | 525176 | Vergl.-Nr. | RACCASRUREP UNK71704633 |
| Beschreibung | Achse ø 8mm L 76mm CNS | | |
| Für Modelle: | Chimaera, Cubo-2gr-Elettronico, Cubo-2gr-Manuale, Cubo-3gr-Elettronico, Cubo-3gr-Manuale, Cubo-4gr-Elettronico, Cubo-4gr-Manuale, Minimax-Replica-Elettronica, Replica-2gr-elettronica-multiboiler, Replica-2gr-manuale-multiboiler, Replica-3gr-elettronica-multiboiler, Replica-3gr-manuale-multiboiler, Replica-elettronica-2gr, Replica-elettronica-3gr, Replica-elettronica-4gr, Replica-manuale-2gr, Replica-manuale-3gr, Replica-manuale-4gr | | |

Dichtungen



| | | | |
|---------------------|---|-------------------|---------------|
| GEV-Nr. | 527960 | Vergl.-Nr. | GUARSILRUBEVO |
| Beschreibung | Dichtung D1 ø 12mm Materialstärke 6mm für Dampf-/Wasserhahn | | |
| Für Modelle: | Evolution-2gr-elettronica-e-puls, Evolution-3gr-elettronica-e-puls, Minimax-Kometa-Elettronica, Minimax-Kometa-Pulsante, Revolution-2gr-elettronica-epuls, Revolution-3gr-elettronica-epuls | | |



| | | | |
|---------------------|---|-------------------|--------|
| GEV-Nr. | 529795 | Vergl.-Nr. | GUARPI |
| Beschreibung | Dichtung D1 ø 13mm D2 ø 4mm Materialstärke 4mm Kaffeemaschine | | |
| Für Modelle: | Chimaera, Cubo-2gr-Elettronico, Cubo-2gr-Manuale, Cubo-3gr-Elettronico, Cubo-3gr-Manuale, Cubo-4gr-Elettronico, Cubo-4gr-Manuale, Minimax-Replica-Elettronica, Replica-2gr-elettronica-multiboiler, Replica-2gr-manuale-multiboiler, Replica-3gr-elettronica-multiboiler, Replica-3gr-manuale-multiboiler, Replica-elettronica-2gr, Replica-elettronica-3gr, Replica-elettronica-4gr, Replica-manuale-2gr, Replica-manuale-3gr, Replica-manuale-4gr | | |

Dichtungshalter

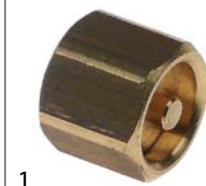

| | | | |
|---------------------|---|-------------------|-------------------------|
| GEV-Nr. | 525175 | Vergl.-Nr. | RACCVARU UNK60394520 |
| Beschreibung | Ventil ø sechskant 16mm L 14mm Messing | | |
| Für Modelle: | Chimaera, Cubo-2gr-Elettronico, Cubo-2gr-Manuale, Cubo-3gr-Elettronico, Cubo-3gr-Manuale, Cubo-4gr-Elettronico, Cubo-4gr-Manuale, Minimax-Replica-Elettronica, Replica-2gr-elettronica-multiboiler, Replica-2gr-manuale-multiboiler, Replica-3gr-elettronica-multiboiler, Replica-3gr-manuale-multiboiler, Replica-elettronica-2gr, Replica-elettronica-3gr, Replica-elettronica-4gr, Replica-manuale-2gr, Replica-manuale-3gr, Replica-manuale-4gr, Replica-pulsante-2gr, Replica-pulsante-3gr, Replica-pulsante-4gr | | |

Federn



| | | | |
|---------------------|---|-------------------|---------------|
| GEV-Nr. | 527958 | Vergl.-Nr. | MOLLAASTAREVO |
| Beschreibung | Druckfeder ø 10.5mm L 32mm Drahtstärke ø 1.3mm für Dampf-/Wasserhahn | | |
| Für Modelle: | Evolution-2gr-elettronica-e-puls, Evolution-3gr-elettronica-e-puls, Minimax-Kometa-Elettronica, Minimax-Kometa-Pulsante, Revolution-2gr-elettronica-epuls, Revolution-3gr-elettronica-epuls | | |

Hahnkörper



| | | | |
|---------------------|---|-------------------|--------------|
| GEV-Nr. | 529898 | Vergl.-Nr. | RACCCORUACVA |
| Beschreibung | Hahnkörper L 63mm | | |
| Für Modelle: | Replica-manuale-2gr, Replica-manuale-3gr, Replica-manuale-4gr, Replica-pulsante-2gr, Replica-pulsante-3gr, Replica-pulsante-4gr | | |



1

| | | | |
|---------------------|---|-------------------|---------------|
| GEV-Nr. | 527962 | Vergl.-Nr. | CORPORUACVAEV |
| Beschreibung | Körper G1: M16x1 G2: 3/8" G3: 1/4" L 49mm | | |
| Für Modelle: | Evolution-2gr-elettronica-e-puls, Evolution-3gr-elettronica-e-puls, Minimax-Kometa-Elettronica, Minimax-Kometa-Pulsante, Revolution-2gr-elettronica-epuls, Revolution-3gr-elettronica-epuls | | |

Unterlegscheiben



1

| | | | |
|---------------------|---|-------------------|---------------|
| GEV-Nr. | 560382 | Vergl.-Nr. | RACCROBLMAEVO |
| Beschreibung | Beilagscheibe D1 ø 6mm D2 ø 20mm Materialstärke 1.5mm Dampf/Wasserhahn | | |
| Für Modelle: | Evolution-2gr-elettronica-e-puls, Evolution-3gr-elettronica-e-puls, Minimax-Kometa-Elettronica, Minimax-Kometa-Pulsante, Revolution-2gr-elettronica-epuls, Revolution-3gr-elettronica-epuls | | |

Verschraubungen



1

| | | | |
|---------------------|---|-------------------|---------------|
| GEV-Nr. | 525174 | Vergl.-Nr. | RACCGUIASTEVO |
| Beschreibung | Verschraubung G1: M16x1 G2: 1/2" L 62mm ID ø 11mm SW 26 Messing | | |
| Für Modelle: | Evolution-2gr-elettronica-e-puls, Evolution-3gr-elettronica-e-puls, Minimax-Kometa-Elettronica, Minimax-Kometa-Pulsante, Revolution-2gr-elettronica-epuls, Revolution-3gr-elettronica-epuls | | |

Wasserhähne

Knebel



1

| | | | |
|---------------------|--|-------------------|------------|
| GEV-Nr. | 111055 | Vergl.-Nr. | MANPRUACVP |
| Beschreibung | Knebel ø 50mm Achse ø 8x7mm schwarz | | |
| Für Modelle: | Replica-pulsante-2gr, Replica-pulsante-3gr, Replica-pulsante-4gr | | |

Wasserhähne



1

| | | | | |
|---|---|-------------------|-------------------|-----------------------------|
| GEV-Nr. | 529897 | Vergl.-Nr. | RACCRUBACREP | |
| Beschreibung | Wasserhahn Eingang 1/4" Ausgang 3/8" Gewinde 3/8" Achse 6.6mm | | | |
| Für Modelle: | Replica-manuale-2gr, Replica-manuale-3gr, Replica-manuale-4gr | | | |
| Zubehör für | 529897 | | | |
|  | GEV-Nr. | 111028 | Vergl.-Nr. | MANPRUAA-CRE UNK90878825 |
| Sterngriff Achse 7x7mm ø 64mm L 24mm schwarz | | | | |



1

| | | | |
|---------------------|---|-------------------|---------------|
| GEV-Nr. | 525188 | Vergl.-Nr. | RACCRUBACKNEW |
| Beschreibung | Wasserhahn Eingang 1/4" Rohrlänge 80mm Rohr ø 8mm | | |
| Für Modelle: | Evolution-2gr-elettronica-e-puls, Evolution-3gr-elettronica-e-puls, Minimax-Kometa-Elettronica, Minimax-Kometa-Pulsante, Revolution-2gr-elettronica-epuls, Revolution-3gr-elettronica-epuls | | |





1

| | | | |
|---------------------|--|-------------------|---------------|
| GEV-Nr. | 525189 | Vergl.-Nr. | RACCRUBDOACCR |
| Beschreibung | Wasserhahn Eingang 1/4" Rohrlänge 80mm Rohr ø 8mm | | |
| Für Modelle: | Domobar-Junior-2B, Domobar-Junior-HX, Domobar-Super-2b-Pid-Elettronica, Domobar-Super-2b-Pid-Manuale, Domobar-Super-Elettronica, Domobar-Super-Manuale | | |



1

| | | | | |
|---|--|-------------------|-------------------------------|------------|
| GEV-Nr. | 529890 | Vergl.-Nr. | RACCRUBACMEIN RACCRUBACMER | |
| Beschreibung | Wasserhahn mit Wasserrohr | | | |
| Für Modelle: | Replica-pulsante-2gr, Replica-pulsante-3gr, Replica-pulsante-4gr | | | |
| Ersatzteile für | 529890 | | | |
|  | GEV-Nr. | 529892 | Vergl.-Nr. | TUBIACSF |
| | Wasserrohr Gewinde 3/8" | | | |
| Zubehör für | 529890 | | | |
|  | GEV-Nr. | 111055 | Vergl.-Nr. | MANPRUACVP |
| | Knebel ø 50mm Achse ø 8x7mm schwarz | | | |

Dampf-/Wasserrohre

Dampfrohre



1

| | | | |
|---------------------|--|-------------------|-------------|
| GEV-Nr. | 525192 | Vergl.-Nr. | TUBILADOMSU |
| Beschreibung | Dampfrohr EP links Gewinde 3/8" H 180mm Rohr ø 8mm Messing verchromt | | |
| Für Modelle: | Domobar-Junior-2B, Domobar-Junior-HX, Domobar-Super-2b-Pid-Elettronica, Domobar-Super-2b-Pid-Manuale, Domobar-Super-Elettronica, Domobar-Super-Manuale | | |



1

| | | | |
|---------------------|---|-------------------|-----------------------------|
| GEV-Nr. | 529819 | Vergl.-Nr. | TUBILANCVASX UNK88470801 |
| Beschreibung | Dampfrohr EP links Gewinde 3/8" H 200mm Rohr ø 8mm Messing verchromt | | |
| Für Modelle: | Cubo-2gr-Elettronico, Cubo-2gr-Manuale, Cubo-3gr-Elettronico, Cubo-3gr-Manuale, Cubo-4gr-Elettronico, Cubo-4gr-Manuale, Minimax-Replica-Elettronica, Replica-2gr-elettronica-multiboiler, Replica-2gr-manuale-multiboiler, Replica-3gr-elettronica-multiboiler, Replica-3gr-manuale-multiboiler, Replica-elettronica-2gr, Replica-elettronica-3gr, Replica-elettronica-4gr, Replica-manuale-2gr, Replica-manuale-3gr, Replica-manuale-4gr | | |



1

| | | | |
|---------------------|--|-------------------|---------------|
| GEV-Nr. | 525195 | Vergl.-Nr. | TUBILANVASXKI |
| Beschreibung | Dampfrohr EP links Gewinde 3/8" H 250mm Rohr ø 8mm Messing verchromt | | |
| Für Modelle: | Lollo-1gruppo, Lollo-2gruppi, Lollo-3gruppi | | |



1

| | | | |
|---------------------|---|-------------------|-----------------------------|
| GEV-Nr. | 529818 | Vergl.-Nr. | TUBILANCVADX UNK88470801 |
| Beschreibung | Dampfrohr EP rechts Gewinde 3/8" H 200mm Rohr ø 8mm Messing verchromt | | |
| Für Modelle: | Cubo-2gr-Elettronico, Cubo-2gr-Manuale, Cubo-3gr-Elettronico, Cubo-3gr-Manuale, Cubo-4gr-Elettronico, Cubo-4gr-Manuale, Minimax-Replica-Elettronica, Replica-2gr-elettronica-multiboiler, Replica-2gr-manuale-multiboiler, Replica-3gr-elettronica-multiboiler, Replica-3gr-manuale-multiboiler, Replica-elettronica-2gr, Replica-elettronica-3gr, Replica-elettronica-4gr, Replica-manuale-2gr, Replica-manuale-3gr, Replica-manuale-4gr | | |



1

| | | | |
|---------------------|---|-------------------|---------------|
| GEV-Nr. | 525196 | Vergl.-Nr. | TUBILANVADXKI |
| Beschreibung | Dampfrohr EP rechts Gewinde 3/8" H 250mm Rohr ø 8mm Messing verchromt | | |
| Für Modelle: | Lollo-1gruppo, Lollo-2gruppi, Lollo-3gruppi | | |



1

| | | | |
|---------------------|---|-------------------|--------------------------------|
| GEV-Nr. | 531082 | Vergl.-Nr. | TUBILAVACOMEV TUBIVALFREVEV |
| Beschreibung | Dampfrohr Gewinde 3/8" H 190mm L 80mm Rohr ø 8mm | | |
| Für Modelle: | Evolution-2gr-elettronica-e-puls, Evolution-3gr-elettronica-e-puls, Minimax-Kometa-Elettronica, Minimax-Kometa-Pulsante, Revolution-2gr-elettronica-epuls, Revolution-3gr-elettronica-epuls | | |



1

| | | | |
|---------------------|--|-------------------|--------------------------|
| GEV-Nr. | 529893 | Vergl.-Nr. | TUBIVALF TUBIVALFINOX |
| Beschreibung | Dampfrohr IG 3/8" | | |
| Für Modelle: | Replica-pulsante-2gr, Replica-pulsante-3gr, Replica-pulsante-4gr | | |

Wasserrohre

| | | | |
|---|--|-------------------|----------|
|  | | | |
| 1 | | | |
| GEV-Nr. | 529892 | Vergl.-Nr. | TUBIACSF |
| Beschreibung | Wasserrohr Gewinde 3/8" | | |
| Für Modelle: | Replica-pulsante-2gr, Replica-pulsante-3gr, Replica-pulsante-4gr | | |

| | | | |
|---|--|-------------------|----------|
|  | | | |
| 1 | | | |
| GEV-Nr. | 525194 | Vergl.-Nr. | TUBIP727 |
| Beschreibung | Wasserrohr Gewinde 3/8" L 90mm Rohr ø 8mm SW 24 Messing verchromt | | |
| Für Modelle: | Domobar-Junior-2B, Domobar-Junior-HX, Domobar-Super-2b-Pid-Elettronica, Domobar-Super-2b-Pid-Manuale, Domobar-Super-Elettronica, Domobar-Super-Manuale, Lollo-1gruppo, Lollo-2gruppi, Lollo-3gruppi, Replica-manuale-2gr, Replica-manuale-3gr, Replica-manuale-4gr | | |

Zubehör

Buchsen

| | | | |
|---|---|-------------------|--------------------------|
|  | | | |
| 1 | | | |
| GEV-Nr. | 527971 | Vergl.-Nr. | RACCBUIASF RACCBULASF |
| Beschreibung | Buchse D1 ø 7.8mm D2 ø 15mm H 21.5mm Messing ID ø 6mm | | |
| Für Modelle: | Chimaera, Cubo-2gr-Elettronico, Cubo-2gr-Manuale, Cubo-3gr-Elettronico, Cubo-3gr-Manuale, Cubo-4gr-Elettronico, Cubo-4gr-Manuale, Domobar-Junior-2B, Domobar-Junior-HX, Domobar-Super-2b-Pid-Elettronica, Domobar-Super-2b-Pid-Manuale, Domobar-Super-Elettronica, Domobar-Super-Manuale, Evolution-2gr-elettronica-e-puls, Evolution-3gr-elettronica-e-puls, Lollo-1gruppo, Lollo-2gruppi, Lollo-3gruppi, Minimax-Kometa-Elettronica, Minimax-Kometa-Pulsante, Minimax-Replica-Elettronica, Replica-2gr-elettronica-multiboiler, Replica-2gr-manuale-multiboiler, Replica-3gr-elettronica-multiboiler, Replica-3gr-manuale-multiboiler, Replica-elettronica-2gr, Replica-elettronica-3gr, Replica-elettronica-4gr, Replica-manuale-2gr, Replica-manuale-3gr, Replica-manuale-4gr, Replica-pulsante-2gr, Replica-pulsante-3gr, Replica-pulsante-4gr, Revolution-2gr-elettronica-epuls, Revolution-3gr-elettronica-epuls | | |

| | | | |
|---|---|-------------------|---------------|
|  | | | |
| 1 | | | |
| GEV-Nr. | 529705 | Vergl.-Nr. | RACCRUSASREVO |
| Beschreibung | Buchse D1 ø 8.3mm D2 ø 12mm H 6mm Messing ID ø 7mm | | |
| Für Modelle: | Evolution-2gr-elettronica-e-puls, Evolution-3gr-elettronica-e-puls, Minimax-Kometa-Elettronica, Minimax-Kometa-Pulsante, Revolution-2gr-elettronica-epuls, Revolution-3gr-elettronica-epuls | | |

Rohrgriffe

| | | | |
|--|---|-------------------|------------------------------|
|  | | | |
| 1 | | | |
| GEV-Nr. | 528625 | Vergl.-Nr. | GOMMALANCIAVA UNK60613522 |
| Beschreibung | Rohrgriff L 35mm Gummi ID ø 8mm | | |
| Für Modelle: | Chimaera, Cubo-2gr-Elettronico, Cubo-2gr-Manuale, Cubo-3gr-Elettronico, Cubo-3gr-Manuale, Cubo-4gr-Elettronico, Cubo-4gr-Manuale, Minimax-Replica-Elettronica, Replica-2gr-elettronica-multiboiler, Replica-2gr-manuale-multiboiler, Replica-3gr-elettronica-multiboiler, Replica-3gr-manuale-multiboiler, Replica-elettronica-2gr, Replica-elettronica-3gr, Replica-elettronica-4gr, Replica-manuale-2gr, Replica-manuale-3gr, Replica-manuale-4gr, Replica-pulsante-2gr, Replica-pulsante-3gr, Replica-pulsante-4gr | | |

Feinfilter

| | | | |
|---|---|-------------------|-------------|
|  | | | |
| 1 | | | |
| GEV-Nr. | 529979 | Vergl.-Nr. | FILTGIGLEUR |
| Beschreibung | Feinfilter ø 8.8mm H 22mm | | |
| Für Modelle: | Chimaera, Cubo-2gr-Elettronico, Cubo-3gr-Elettronico, Cubo-4gr-Elettronico, Domobar-Super-2b-Pid-Elettronica, Domobar-Super-Elettronica, Evolution-2gr-elettronica-e-puls, Evolution-3gr-elettronica-e-puls, Lollo-1gruppo, Lollo-2gruppi, Lollo-3gruppi, Minimax-Kometa-Elettronica, Minimax-Kometa-Pulsante, Minimax-Replica-Elettronica, Replica-2gr-elettronica-multiboiler, Replica-3gr-elettronica-multiboiler, Replica-elettronica-2gr, Replica-elettronica-3gr, Replica-elettronica-4gr, Replica-pulsante-2gr, Replica-pulsante-3gr, Replica-pulsante-4gr, Revolution-2gr-elettronica-epuls, Revolution-3gr-elettronica-epuls | | |

Füllventile

| | | | |
|---|----------------------------|-------------------|--------------|
|  | | | |
| 1 | | | |
| GEV-Nr. | 529533 | Vergl.-Nr. | ASSRUBCAAMER |
| Beschreibung | Füllventil Messing L 105mm | | |

| | | | |
|--|---|-------------------|---------------|
|  | | | |
| 1 | | | |
| GEV-Nr. | 525184 | Vergl.-Nr. | RACCRUBCARLOL |
| Beschreibung | Füllventil mit Expansionventil Eingang 3/8" Ausgang 3/8"-1/8" | | |
| Für Modelle: | Chimaera, Evolution-2gr-elettronica-e-puls, Evolution-3gr-elettronica-e-puls, Lollo-1gruppo, Lollo-2gruppi, Lollo-3gruppi, Replica-2gr-elettronica-multiboiler, Replica-2gr-manuale-multiboiler, Replica-3gr-elettronica-multiboiler, Replica-3gr-manuale-multiboiler, Revolution-2gr-elettronica-epuls | | |

| | | | |
|---|--|-------------------|---------------|
|  | | | |
| 1 | | | |
| GEV-Nr. | 525197 | Vergl.-Nr. | RACCRUBCARNEW |
| Beschreibung | Füllventil mit Expansionsventil Eingang 3/8" konisch dichtend Ausgang 3/8" | | |
| Für Modelle: | Evolution-2gr-elettronica-e-puls, Evolution-3gr-elettronica-e-puls, Revolution-2gr-elettronica-epuls, Revolution-3gr-elettronica-epuls | | |

Zubehör

Dichtungen

| | | | |
|---|--|-------------------|-------------|
|  <p>Bild nicht vorhanden</p> | | | |
| 1 | | | |
| GEV-Nr. | 531096 | Vergl.-Nr. | GUARASRUMER |
| Beschreibung | Dichtung | | |
| Für Modelle: | Cubo-2gr-Elettronico, Cubo-2gr-Manuale, Cubo-3gr-Elettronico, Cubo-3gr-Manuale, Cubo-4gr-Elettronico, Cubo-4gr-Manuale, Minimax-Kometa-Elettronica, Minimax-Kometa-Pulsante, Minimax-Replica-Elettronica, Replica-elettronica-2gr, Replica-elettronica-3gr, Replica-elettronica-4gr, Replica-manuale-2gr, Replica-manuale-3gr, Replica-manuale-4gr, Replica-pulsante-2gr, Replica-pulsante-3gr, Replica-pulsante-4gr | | |

Sonstige

| | | | |
|---|--|-------------------|------------------------------|
|  <p>Bild nicht vorhanden</p> | | | |
| 1 | | | |
| GEV-Nr. | 531097 | Vergl.-Nr. | VITERON31MER VITERON3IMER |
| Beschreibung | Unterlegscheibe | | |
| Für Modelle: | Cubo-2gr-Elettronico, Cubo-2gr-Manuale, Cubo-3gr-Elettronico, Cubo-3gr-Manuale, Cubo-4gr-Elettronico, Cubo-4gr-Manuale, Minimax-Kometa-Elettronica, Minimax-Kometa-Pulsante, Minimax-Replica-Elettronica, Replica-elettronica-2gr, Replica-elettronica-3gr, Replica-elettronica-4gr, Replica-manuale-2gr, Replica-manuale-3gr, Replica-manuale-4gr, Replica-pulsante-2gr, Replica-pulsante-3gr, Replica-pulsante-4gr | | |

Ventile

| | | | |
|---|--|-------------------|---------------|
|  | | | |
| 1 | | | |
| GEV-Nr. | 531100 | Vergl.-Nr. | ASSVALVNONRIT |
| Beschreibung | Ventil für Füllventil | | |
| Für Modelle: | Cubo-2gr-Elettronico, Cubo-2gr-Manuale, Cubo-3gr-Elettronico, Cubo-3gr-Manuale, Cubo-4gr-Elettronico, Cubo-4gr-Manuale, Minimax-Kometa-Elettronica, Minimax-Kometa-Pulsante, Minimax-Replica-Elettronica, Replica-elettronica-2gr, Replica-elettronica-3gr, Replica-elettronica-4gr, Replica-manuale-2gr, Replica-manuale-3gr, Replica-manuale-4gr, Replica-pulsante-2gr, Replica-pulsante-3gr, Replica-pulsante-4gr | | |



Niveauschaugläser

Niveauschaugläser

Druckringe

| | | | |
|---|--|-------------------|----------|
|  | | | |
| 1 | | | |
| GEV-Nr. | 525201 | Vergl.-Nr. | RACCP224 |
| Beschreibung | Druckring D1 ø 14.5mm D2 ø 11.5mm Materialstärke 3.5mm Innenkonus Messing | | |
| Für Modelle: | Cubo-2gr-Elettronico, Cubo-2gr-Manuale, Cubo-3gr-Elettronico, Cubo-3gr-Manuale, Cubo-4gr-Elettronico, Cubo-4gr-Manuale, Evolution-2gr-elettronica-e-puls, Evolution-3gr-elettronica-e-puls, Minimax-Kometa-Elettronica, Minimax-Kometa-Pulsante, Minimax-Replica-Elettronica, Replica-elettronica-2gr, Replica-elettronica-3gr, Replica-elettronica-4gr, Replica-manuale-2gr, Replica-manuale-3gr, Replica-manuale-4gr, Replica-pulsante-2gr, Replica-pulsante-3gr, Replica-pulsante-4gr, Revolution-2gr-elettronica-epuls, Revolution-3gr-elettronica-epuls | | |

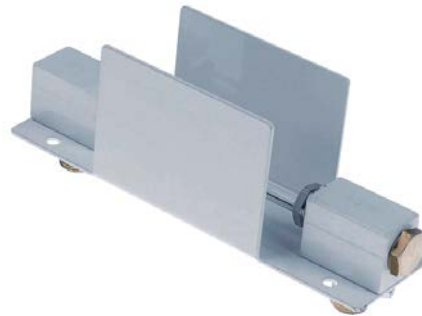
Schaugläser komplett

| | | | |
|---|--|-------------------|--------------|
|  | | | |
| 1 | | | |
| GEV-Nr. | 529235 | Vergl.-Nr. | ASSLIVUNIFMN |
| Beschreibung | Füllstandsrohr L 200mm B 55mm komplett Gewinde 3/8" | | |
| Zubehör für | 529235 | | |
| | GEV-Nr. | Vergl.-Nr. | MATECVELI140 |
|  | Füllstandsrohr ø 11mm H 140mm ID ø 8mm Markierung Min/Max | | |
| | GEV-Nr. | Vergl.-Nr. | — |
|  | Druckring D1 ø 11.3mm D2 ø 14.6mm Materialstärke 3mm | | |
| | GEV-Nr. | Vergl.-Nr. | — |
|  | Überwurfschraube Gewinde 3/8" Loch ø 12.5mm H 12mm SW 17 Messing | | |
| | GEV-Nr. | Vergl.-Nr. | GUAROR113 |
|  | O-Ring EPDM Materialstärke 2.62mm ID ø 10.78mm VPE 1 Stück | | |

| | | | |
|--|--|-------------------|-------------------|
|  | | | |
| 1 | | | |
| GEV-Nr. | 529236 | Vergl.-Nr. | ASSLIVUNIF |
| Beschreibung | Füllstandsrohr L 200mm B 55mm komplett Gewinde 3/8" | | |
| Für Modelle: | Cubo-2gr-Elettronico, Cubo-2gr-Manuale, Cubo-3gr-Elettronico, Cubo-3gr-Manuale, Cubo-4gr-Elettronico, Cubo-4gr-Manuale, Evolution-2gr-elettronica-e-puls, Evolution-3gr-elettronica-e-puls, Minimax-Kometa-Elettronica, Minimax-Kometa-Pulsante, Minimax-Replica-Elettronica, Replica-elettronica-2gr, Replica-elettronica-3gr, Replica-elettronica-4gr, Replica-manuale-2gr, Replica-manuale-3gr, Replica-manuale-4gr, Replica-pulsante-2gr, Replica-pulsante-3gr, Replica-pulsante-4gr, Revolution-2gr-elettronica-epuls, Revolution-3gr-elettronica-epuls | | |
| Zubehör für | 529236 | | |
| | GEV-Nr. | 529393 | Vergl.-Nr. |
|  | | | MATECVELI140 |
| | GEV-Nr. | 529396 | Vergl.-Nr. |
|  | | | — |
| | GEV-Nr. | 529397 | Vergl.-Nr. |
|  | | | — |
| | GEV-Nr. | 529412 | Vergl.-Nr. |
|  | | | GUAROR113 |

| | | | |
|---|--|-------------------|--------------|
| Schauglasrohre | | | |
|  | | | |
| 1 | | | |
| GEV-Nr. | 529393 | Vergl.-Nr. | MATECVELI140 |
| Beschreibung | Füllstandsrohr ø 11mm H 140mm ID ø 8mm Markierung Min/Max | | |
| Für Modelle: | Cubo-2gr-Elettronico, Cubo-2gr-Manuale, Cubo-3gr-Elettronico, Cubo-3gr-Manuale, Cubo-4gr-Elettronico, Cubo-4gr-Manuale, Evolution-2gr-elettronica-e-puls, Evolution-3gr-elettronica-e-puls, Minimax-Kometa-Elettronica, Minimax-Kometa-Pulsante, Minimax-Replica-Elettronica, Replica-elettronica-2gr, Replica-elettronica-3gr, Replica-elettronica-4gr, Replica-manuale-2gr, Replica-manuale-3gr, Replica-manuale-4gr, Replica-pulsante-2gr, Replica-pulsante-3gr, Replica-pulsante-4gr, Revolution-2gr-elettronica-epuls, Revolution-3gr-elettronica-epuls | | |

| | | | |
|--|--|-------------------|----------|
| Verschraubungen | | | |
|  | | | |
| 1 | | | |
| GEV-Nr. | 526676 | Vergl.-Nr. | RACCP227 |
| Beschreibung | Überwurfschraube Gewinde 3/8" Loch ø 12mm H 12mm SW 17 Messing verchromt | | |
| Für Modelle: | Cubo-2gr-Elettronico, Cubo-2gr-Manuale, Cubo-3gr-Elettronico, Cubo-3gr-Manuale, Cubo-4gr-Elettronico, Cubo-4gr-Manuale, Evolution-2gr-elettronica-e-puls, Evolution-3gr-elettronica-e-puls, Minimax-Kometa-Elettronica, Minimax-Kometa-Pulsante, Minimax-Replica-Elettronica, Replica-elettronica-2gr, Replica-elettronica-3gr, Replica-elettronica-4gr, Replica-manuale-2gr, Replica-manuale-3gr, Replica-manuale-4gr, Replica-pulsante-2gr, Replica-pulsante-3gr, Replica-pulsante-4gr, Revolution-2gr-elettronica-epuls, Revolution-3gr-elettronica-epuls | | |

| | | | |
|---|---|-------------------|---------------------|
| Knebel | | | |
| Dampf-/Wasserhähne | | | |
| Dampf-/Wasserhähne | | | |
|  | | | |
| 1 | | | |
| GEV-Nr. | 111351 | Vergl.-Nr. | MANPRSC MANPRUSC |
| Beschreibung | Drehgriff ø 40mm Achse 6x6mm schwarz | | |
| Für Modelle: | Domobar-Interruttore-Levetta, Domobar-Interruttore-Luminoso, Domobar-Junior-2B, Domobar-Junior-HX, Domobar-Super-2b-Pid-Elettronica, Domobar-Super-2b-Pid-Manuale, Domobar-Super-Elettronica, Domobar-Super-Manuale | | |

| | | | |
|---|---|-------------------|---------------|
|  | | | |
| 1 | | | |
| GEV-Nr. | 111355 | Vergl.-Nr. | MANPRUACUPEVO |
| Beschreibung | Drehgriff ø 42mm L 49mm schwarz | | |
| Für Modelle: | Evolution-2gr-elettronica-e-puls, Evolution-3gr-elettronica-e-puls, Minimax-Kometa-Elettronica, Minimax-Kometa-Pulsante, Revolution-2gr-elettronica-epuls, Revolution-3gr-elettronica-epuls | | |

| | | | |
|---|--|-------------------|------------------------------|
|  | | | |
| 1 | | | |
| GEV-Nr. | 111352 | Vergl.-Nr. | MANPRUSCDOMSA UNK57161488 |
| Beschreibung | Drehgriff ø 50mm Achse 6x6mm schwarz | | |
| Für Modelle: | Domobar-Junior-2B, Domobar-Junior-HX, Domobar-Super-2b-Pid-Elettronica, Domobar-Super-2b-Pid-Manuale, Domobar-Super-Elettronica, Domobar-Super-Manuale | | |

| | | | |
|---|--|-------------------|------------|
|  | | | |
| 1 | | | |
| GEV-Nr. | 111055 | Vergl.-Nr. | MANPRUACVP |
| Beschreibung | Knebel ø 50mm Achse ø 8x7mm schwarz | | |
| Für Modelle: | Replica-pulsante-2gr, Replica-pulsante-3gr, Replica-pulsante-4gr | | |

Zubehör



| | | | |
|---------------------|---|-------------------|-----------------------------|
| GEV-Nr. | 111028 | Vergl.-Nr. | MANPRUVAACRE UNK90878825 |
| Beschreibung | Sterngriff Achse 7x7mm ø 64mm L 24mm schwarz | | |
| Für Modelle: | Chimaera, Cubo-2gr-Elettronico, Cubo-2gr-Manuale, Cubo-3gr-Elettronico, Cubo-3gr-Manuale, Cubo-4gr-Elettronico, Cubo-4gr-Manuale, Minimax-Replica-Elettronica, Replica-2gr-elettronica-multiboiler, Replica-2gr-manuale-multiboiler, Replica-3gr-elettronica-multiboiler, Replica-3gr-manuale-multiboiler, Replica-elettronica-2gr, Replica-elettronica-3gr, Replica-elettronica-4gr, Replica-manuale-2gr, Replica-manuale-3gr, Replica-manuale-4gr | | |



| | | | |
|---------------------|--|-------------------|--------------------------|
| GEV-Nr. | 530293 | Vergl.-Nr. | GUAROR108 UNK43672353 |
| Beschreibung | O-Ring EPDM Materialstärke 1.78mm ID ø 8.73mm VPE 1 Stück | | |
| Für Modelle: | Cubo-2gr-Elettronico, Cubo-2gr-Manuale, Cubo-3gr-Elettronico, Cubo-3gr-Manuale, Cubo-4gr-Elettronico, Cubo-4gr-Manuale, Minimax-Kometa-Elettronica, Minimax-Kometa-Pulsante, Minimax-Replica-Elettronica, Replica-elettronica-2gr, Replica-elettronica-3gr, Replica-elettronica-4gr, Replica-manuale-2gr, Replica-manuale-3gr, Replica-manuale-4gr, Replica-pulsante-2gr, Replica-pulsante-3gr, Replica-pulsante-4gr | | |

Griffe und Handräder

Konusgriffe



| | | | |
|---------------------|--|-------------------|----------|
| GEV-Nr. | 111092 | Vergl.-Nr. | MANPPOLE |
| Beschreibung | Konusgriff Gewinde M8 ø 25mm L 41mm schwarz | | |
| Für Modelle: | Cubo-2gr-Manuale, Cubo-3gr-Manuale, Cubo-4gr-Manuale, Domobar-Interruttore-Levetta, Domobar-Interruttore-Luminoso, Domobar-Junior-2B, Domobar-Junior-HX, Domobar-Super-2b-Pid-Manuale, Domobar-Super-Manuale, Lollo-1gruppo, Lollo-2gruppi, Lollo-3gruppi, Replica-2gr-manuale-multiboiler, Replica-3gr-manuale-multiboiler, Replica-manuale-2gr, Replica-manuale-3gr, Replica-manuale-4gr | | |

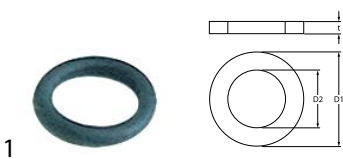

| | | | |
|---------------------|---|-------------------|-----------|
| GEV-Nr. | 529412 | Vergl.-Nr. | GUAROR113 |
| Beschreibung | O-Ring EPDM Materialstärke 2.62mm ID ø 10.78mm VPE 1 Stück | | |
| Für Modelle: | Chimaera, Cubo-2gr-Elettronico, Cubo-2gr-Manuale, Cubo-3gr-Elettronico, Cubo-3gr-Manuale, Cubo-4gr-Elettronico, Cubo-4gr-Manuale, Domobar-Junior-2B, Domobar-Junior-HX, Domobar-Super-2b-Pid-Elettronica, Domobar-Super-2b-Pid-Manuale, Domobar-Super-Elettronica, Domobar-Super-Manuale, Evolution-2gr-elettronica-e-puls, Evolution-3gr-elettronica-e-puls, Lollo-1gruppo, Lollo-2gruppi, Lollo-3gruppi, Minimax-Kometa-Elettronica, Minimax-Kometa-Pulsante, Minimax-Replica-Elettronica, Replica-2gr-elettronica-multiboiler, Replica-2gr-manuale-multiboiler, Replica-3gr-elettronica-multiboiler, Replica-3gr-manuale-multiboiler, Replica-elettronica-2gr, Replica-elettronica-3gr, Replica-elettronica-4gr, Replica-manuale-2gr, Replica-manuale-3gr, Replica-manuale-4gr, Replica-pulsante-2gr, Replica-pulsante-3gr, Replica-pulsante-4gr, Revolution-2gr-elettronica-epuls, Revolution-3gr-elettronica-epuls | | |

Dichtungen

O-Ringe

EPDM



| | | | |
|---------------------|--|-------------------|--------|
| GEV-Nr. | 510177 | Vergl.-Nr. | GUARR6 |
| Beschreibung | O-Ring EPDM Materialstärke 1.78mm ID ø 7.66mm VPE 1 Stück | | |
| Für Modelle: | Chimaera, Cubo-2gr-Elettronico, Cubo-2gr-Manuale, Cubo-3gr-Elettronico, Cubo-3gr-Manuale, Cubo-4gr-Elettronico, Cubo-4gr-Manuale, Domobar-Interruttore-Levetta, Domobar-Interruttore-Luminoso, Domobar-Junior-2B, Domobar-Junior-HX, Domobar-Super-2b-Pid-Elettronica, Domobar-Super-2b-Pid-Manuale, Domobar-Super-Elettronica, Domobar-Super-Manuale, Evolution-2gr-elettronica-e-puls, Evolution-3gr-elettronica-e-puls, Lollo-1gruppo, Lollo-2gruppi, Lollo-3gruppi, Minimax-Kometa-Elettronica, Minimax-Kometa-Pulsante, Minimax-Replica-Elettronica, Replica-2gr-elettronica-multiboiler, Replica-2gr-manuale-multiboiler, Replica-3gr-elettronica-multiboiler, Replica-3gr-manuale-multiboiler, Replica-elettronica-2gr, Replica-elettronica-3gr, Replica-elettronica-4gr, Replica-manuale-2gr, Replica-manuale-3gr, Replica-manuale-4gr, Replica-pulsante-2gr, Replica-pulsante-3gr, Replica-pulsante-4gr, Revolution-2gr-elettronica-epuls, Revolution-3gr-elettronica-epuls | | |



| | | | |
|---------------------|---|-------------------|-----------|
| GEV-Nr. | 505073 | Vergl.-Nr. | GUAROR128 |
| Beschreibung | O-Ring EPDM Materialstärke 2.62mm ID ø 20.63mm VPE 1 Stück | | |
| Für Modelle: | Cubo-2gr-Manuale, Cubo-3gr-Manuale, Cubo-4gr-Manuale, Domobar-Interruttore-Levetta, Domobar-Interruttore-Luminoso, Domobar-Junior-2B, Domobar-Junior-HX, Domobar-Super-2b-Pid-Manuale, Domobar-Super-Manuale, Replica-2gr-manuale-multiboiler, Replica-3gr-manuale-multiboiler, Replica-manuale-2gr, Replica-manuale-3gr, Replica-manuale-4gr | | |

Viton

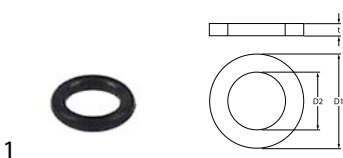

| | | | |
|---------------------|---|-------------------|-------------|
| GEV-Nr. | 371095 | Vergl.-Nr. | GUARASTRUEV |
| Beschreibung | O-Ring Viton Materialstärke 1.78mm ID ø 6.07mm VPE 1 Stück | | |
| Für Modelle: | Evolution-2gr-elettronica-e-puls, Evolution-3gr-elettronica-e-puls, Minimax-Kometa-Elettronica, Minimax-Kometa-Pulsante, Revolution-2gr-elettronica-epuls, Revolution-3gr-elettronica-epuls | | |

Dichtungsringe

Fiberdichtungen



| | | | |
|---------------------|--|-------------------|-----|
| GEV-Nr. | 510405 | Vergl.-Nr. | N/A |
| Beschreibung | Flachdichtung Fiber AD ø 56mm ID ø 42mm Materialstärke 2mm für Gewinde 1¼" VPE 1 Stück | | |

Kupferdichtungen

DIN-7603-A



| | | | |
|---------------------|---|-------------------|---------------|
| GEV-Nr. | 526461 | Vergl.-Nr. | RACCRONRARVEV |
| Beschreibung | Flachdichtung Kupfer AD ø 22mm ID ø 17mm Materialstärke 2mm VPE 1 Stück | | |
| Für Modelle: | Evolution-2gr-elettronica-e-puls, Evolution-3gr-elettronica-e-puls, Minimax-Kometa-Elettronica, Minimax-Kometa-Pulsante, Revolution-2gr-elettronica-epuls, Revolution-3gr-elettronica-epuls | | |

PTFE-Dichtungen



| | | | |
|---------------------|--|-------------------|---------------|
| GEV-Nr. | 526554 | Vergl.-Nr. | VITERON6TEFLO |
| Beschreibung | Flachdichtung PTFE AD ø 10mm ID ø 6mm Materialstärke 1mm VPE 1 Stück | | |
| Für Modelle: | Chimaera, Cubo-2gr-Elettronico, Cubo-2gr-Manuale, Cubo-3gr-Elettronico, Cubo-3gr-Manuale, Cubo-4gr-Elettronico, Cubo-4gr-Manuale, Domobar-Interruttore-Levetta, Domobar-Interruttore-Luminoso, Domobar-Junior-2B, Domobar-Junior-HX, Domobar-Super-2b-Pid-Elettronica, Domobar-Super-2b-Pid-Manuale, Domobar-Super-Elettronica, Domobar-Super-Manuale, Evolution-2gr-elettronica-e-puls, Evolution-3gr-elettronica-e-puls, Lollo-1gruppo, Lollo-2gruppi, Lollo-3gruppi, Minimax-Kometa-Elettronica, Minimax-Kometa-Pulsante, Minimax-Replica-Elettronica, Replica-2gr-elettronica-multiboiler, Replica-2gr-manuale-multiboiler, Replica-3gr-elettronica-multiboiler, Replica-3gr-manuale-multiboiler, Replica-elettronica-2gr, Replica-elettronica-3gr, Replica-elettronica-4gr, Replica-manuale-2gr, Replica-manuale-3gr, Replica-manuale-4gr, Replica-pulsante-2gr, Replica-pulsante-3gr, Replica-pulsante-4gr, Revolution-2gr-elettronica-epuls, Revolution-3gr-elettronica-epuls | | |





| | | | |
|---------------------|--|-------------------|---------------|
| GEV-Nr. | 526661 | Vergl.-Nr. | VITERONTPP189 |
| Beschreibung | Flachdichtung PTFE AD ø 17mm ID ø 13mm Materialstärke 2mm VPE 1 Stück | | |
| Für Modelle: | Cubo-2gr-Elettronico, Cubo-2gr-Manuale, Cubo-3gr-Elettronico, Cubo-3gr-Manuale, Cubo-4gr-Elettronico, Cubo-4gr-Manuale, Evolution-2gr-elettronica-e-puls, Evolution-3gr-elettronica-e-puls, Minimax-Kometa-Elettronica, Minimax-Kometa-Pulsante, Minimax-Replica-Elettronica, Replica-elettronica-2gr, Replica-elettronica-3gr, Replica-elettronica-4gr, Replica-manuale-2gr, Replica-manuale-3gr, Replica-manuale-4gr, Replica-pulsante-2gr, Replica-pulsante-3gr, Replica-pulsante-4gr, Revolution-2gr-elettronica-epuls, Revolution-3gr-elettronica-epuls | | |

| | | | |
|---------------------|---|-------------------|--------|
| GEV-Nr. | 525611 | Vergl.-Nr. | GUARTE |
| Beschreibung | Flachdichtung PTFE AD ø 22mm ID ø 17mm Materialstärke 2mm VPE 1 Stück | | |
| Für Modelle: | Cubo-2gr-Elettronico, Cubo-2gr-Manuale, Cubo-3gr-Elettronico, Cubo-3gr-Manuale, Cubo-4gr-Elettronico, Cubo-4gr-Manuale, Domobar-Interruttore-Levetta, Domobar-Interruttore-Luminoso, Domobar-Junior-2B, Domobar-Junior-HX, Domobar-Super-2b-Pid-Manuale, Domobar-Super-Manuale, Evolution-2gr-elettronica-e-puls, Evolution-3gr-elettronica-e-puls, Lollo-1gruppo, Lollo-2gruppi, Lollo-3gruppi, Minimax-Kometa-Elettronica, Minimax-Kometa-Pulsante, Minimax-Replica-Elettronica, Replica-2gr-manuale-multiboiler, Replica-3gr-manuale-multiboiler, Replica-elettronica-2gr, Replica-elettronica-3gr, Replica-elettronica-4gr, Replica-manuale-2gr, Replica-manuale-3gr, Replica-manuale-4gr, Replica-pulsante-2gr, Replica-pulsante-3gr, Replica-pulsante-4gr | | |

| | | | |
|---------------------|--|-------------------|--------------|
| GEV-Nr. | 525199 | Vergl.-Nr. | GUARCASUTEPI |
| Beschreibung | Flachdichtung PTFE AD ø 25.5mm ID ø 21mm Materialstärke 5.5mm VPE 1 Stück | | |
| Für Modelle: | Chimaera, Cubo-2gr-Elettronico, Cubo-2gr-Manuale, Cubo-3gr-Elettronico, Cubo-3gr-Manuale, Cubo-4gr-Elettronico, Cubo-4gr-Manuale, Domobar-Interruttore-Levetta, Domobar-Interruttore-Luminoso, Domobar-Junior-2B, Domobar-Junior-HX, Domobar-Super-2b-Pid-Elettronica, Domobar-Super-2b-Pid-Manuale, Domobar-Super-Elettronica, Domobar-Super-Manuale, Minimax-Replica-Elettronica, Replica-2gr-elettronica-multiboiler, Replica-2gr-manuale-multiboiler, Replica-3gr-elettronica-multiboiler, Replica-3gr-manuale-multiboiler, Replica-elettronica-2gr, Replica-elettronica-3gr, Replica-elettronica-4gr, Replica-manuale-2gr, Replica-manuale-3gr, Replica-manuale-4gr, Replica-pulsante-2gr, Replica-pulsante-3gr, Replica-pulsante-4gr, Revolution-2gr-elettronica-epuls, Revolution-3gr-elettronica-epuls | | |

| | | | |
|---------------------|--|-------------------|------------|
| GEV-Nr. | 528683 | Vergl.-Nr. | GUARTACHGR |
| Beschreibung | Flachdichtung PTFE AD ø 26mm ID ø 21mm Materialstärke 2mm VPE 1 Stück passend für GAGGIA, SPAZIALE | | |
| Für Modelle: | Chimaera, Cubo-2gr-Elettronico, Cubo-2gr-Manuale, Cubo-3gr-Elettronico, Cubo-3gr-Manuale, Cubo-4gr-Elettronico, Cubo-4gr-Manuale, Domobar-Interruttore-Levetta, Domobar-Interruttore-Luminoso, Domobar-Junior-2B, Domobar-Junior-HX, Domobar-Super-2b-Pid-Elettronica, Domobar-Super-2b-Pid-Manuale, Domobar-Super-Elettronica, Domobar-Super-Manuale, Evolution-2gr-elettronica-e-puls, Evolution-3gr-elettronica-e-puls, Lollo-1gruppo, Lollo-2gruppi, Lollo-3gruppi, Minimax-Kometa-Elettronica, Minimax-Kometa-Pulsante, Minimax-Replica-Elettronica, Replica-2gr-elettronica-multiboiler, Replica-2gr-manuale-multiboiler, Replica-3gr-elettronica-multiboiler, Replica-3gr-manuale-multiboiler, Replica-elettronica-2gr, Replica-elettronica-3gr, Replica-elettronica-4gr, Replica-manuale-2gr, Replica-manuale-3gr, Replica-manuale-4gr, Replica-pulsante-2gr, Replica-pulsante-3gr, Replica-pulsante-4gr, Revolution-2gr-elettronica-epuls, Revolution-3gr-elettronica-epuls | | |

| | | | |
|---|--|-------------------|--------------|
|  | | | |
| 1 | | | |
| GEV-Nr. | 526014 | Vergl.-Nr. | GUARCAINGRTE |
| Beschreibung | Flachdichtung PTFE AD ø 35mm ID ø 30mm Materialstärke 2mm VPE 1 Stück | | |
| Für Modelle: | Chimaera, Cubo-2gr-Elettronico, Cubo-2gr-Manuale, Cubo-3gr-Elettronico, Cubo-3gr-Manuale, Cubo-4gr-Elettronico, Cubo-4gr-Manuale, Domobar-Interruttore-Levetta, Domobar-Interruttore-Luminoso, Domobar-Junior-2B, Domobar-Junior-HX, Domobar-Super-2b-Pid-Elettronica, Domobar-Super-2b-Pid-Manuale, Domobar-Super-Elettronica, Domobar-Super-Manuale, Evolution-2gr-elettronica-e-puls, Evolution-3gr-elettronica-e-puls, Lollo-1gruppo, Lollo-2gruppi, Lollo-3gruppi, Minimax-Kometa-Elettronica, Minimax-Kometa-Pulsante, Minimax-Replica-Elettronica, Replica-2gr-elettronica-multiboiler, Replica-2gr-manuale-multiboiler, Replica-3gr-elettronica-multiboiler, Replica-3gr-manuale-multiboiler, Replica-elettronica-2gr, Replica-elettronica-3gr, Replica-elettronica-4gr, Replica-manuale-2gr, Replica-manuale-3gr, Replica-manuale-4gr, Replica-pulsante-2gr, Replica-pulsante-3gr, Replica-pulsante-4gr, Revolution-2gr-elettronica-epuls, Revolution-3gr-elettronica-epuls | | |

| | | | |
|---|---|-------------------|---------------|
|  | | | |
| 1 | | | |
| GEV-Nr. | 528021 | Vergl.-Nr. | GUARRESPICTEF |
| Beschreibung | Flachdichtung PTFE AD ø 53mm ID ø 42.5mm Materialstärke 3mm VPE 1 Stück Vergl.-Nr. 12001/02286 passend für Astoria/Aurora/Brasilia/Wega | | |
| Für Modelle: | Domobar-Super-Elettronica, Domobar-Super-Manuale, Lollo-1gruppo | | |

Spezialdichtungen

Dichtscheiben

| | | | |
|---|---|-------------------|----------------|
|  | | | |
| 1 | | | |
| GEV-Nr. | 525182 | Vergl.-Nr. | GUARSILRUDOMSU |
| Beschreibung | Dichtscheibe ø 9mm Materialstärke 5mm Silikon VPE 1 Stück | | |
| Für Modelle: | Domobar-Super-Elettronica, Domobar-Super-Manuale | | |

Gruppendichtungen

| | | | |
|--|--|-------------------|--------|
|  | | | |
| 1 | | | |
| GEV-Nr. | 528165 | Vergl.-Nr. | GUARGR |
| Beschreibung | Gruppendichtung L 76mm B 72mm Materialstärke 2.5mm Lochgröße 26x64mm LA 55mm | | |
| Für Modelle: | Chimaera, Cubo-2gr-Elettronico, Cubo-2gr-Manuale, Cubo-3gr-Elettronico, Cubo-3gr-Manuale, Cubo-4gr-Elettronico, Cubo-4gr-Manuale, Domobar-Interruttore-Levetta, Domobar-Interruttore-Luminoso, Domobar-Junior-2B, Domobar-Junior-HX, Domobar-Super-2b-Pid-Elettronica, Domobar-Super-2b-Pid-Manuale, Domobar-Super-Elettronica, Domobar-Super-Manuale, Minimax-Replica-Elettronica, Replica-2gr-elettronica-multiboiler, Replica-2gr-manuale-multiboiler, Replica-3gr-elettronica-multiboiler, Replica-3gr-manuale-multiboiler, Replica-elettronica-2gr, Replica-elettronica-3gr, Replica-elettronica-4gr, Replica-manuale-2gr, Replica-manuale-3gr, Replica-manuale-4gr, Replica-pulsante-2gr, Replica-pulsante-3gr, Replica-pulsante-4gr, Revolution-2gr-elettronica-epuls, Revolution-3gr-elettronica-epuls | | |

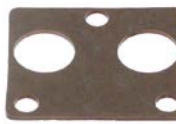
| | | | |
|--|--|-------------------|----------|
|  | | | |
| 1 | | | |
| GEV-Nr. | 525183 | Vergl.-Nr. | GUARGRKO |
| Beschreibung | Gruppendichtung L 72mm B 64mm Materialstärke 2mm LA 56mm | | |
| Für Modelle: | Evolution-2gr-elettronica-e-puls, Evolution-3gr-elettronica-e-puls, Lollo-1gruppo, Lollo-2gruppi, Lollo-3gruppi, Minimax-Kometa-Elettronica, Minimax-Kometa-Pulsante | | |

Federn

Druckfedern

| | | | |
|--|--|-------------------|--------|
|  | | | |
| Bild nicht vorhanden | | | |
| 1 | | | |
| GEV-Nr. | 531094 | Vergl.-Nr. | MOLLSF |
| Beschreibung | Druckfeder | | |
| Für Modelle: | Chimaera, Cubo-2gr-Elettronico, Cubo-2gr-Manuale, Cubo-3gr-Elettronico, Cubo-3gr-Manuale, Cubo-4gr-Elettronico, Cubo-4gr-Manuale, Minimax-Kometa-Elettronica, Minimax-Kometa-Pulsante, Minimax-Replica-Elettronica, Replica-2gr-elettronica-multiboiler, Replica-2gr-manuale-multiboiler, Replica-3gr-elettronica-multiboiler, Replica-3gr-manuale-multiboiler, Replica-elettronica-2gr, Replica-elettronica-3gr, Replica-elettronica-4gr, Replica-manuale-2gr, Replica-manuale-3gr, Replica-manuale-4gr, Replica-pulsante-2gr, Replica-pulsante-3gr, Replica-pulsante-4gr | | |



| | | | |
|---|--|-------------------|--------------|
|  <p>Bild nicht vorhanden</p> | | | |
| GEV-Nr. | 531095 | Vergl.-Nr. | MOLLASRUBMER |
| Beschreibung | Druckfeder | | |
| Für Modelle: | Cubo-2gr-Elettronico, Cubo-2gr-Manuale, Cubo-3gr-Elettronico, Cubo-3gr-Manuale, Cubo-4gr-Elettronico, Cubo-4gr-Manuale, Minimax-Kometa-Elettronica, Minimax-Kometa-Pulsante, Minimax-Replica-Elettronica, Replica-elettronica-2gr, Replica-elettronica-3gr, Replica-elettronica-4gr, Replica-manuale-2gr, Replica-manuale-3gr, Replica-manuale-4gr, Replica-pulsante-2gr, Replica-pulsante-3gr, Replica-pulsante-4gr | | |

| | | | |
|---|---|-------------------|---------------|
|  | | | |
| GEV-Nr. | 527958 | Vergl.-Nr. | MOLLAASTAREVO |
| Beschreibung | Druckfeder ø 10.5mm L 32mm Drahtstärke ø 1.3mm für Dampf/Wasserhahn | | |
| Für Modelle: | Evolution-2gr-elettronica-e-puls, Evolution-3gr-elettronica-e-puls, Minimax-Kometa-Elettronica, Minimax-Kometa-Pulsante, Revolution-2gr-elettronica-epuls, Revolution-3gr-elettronica-epuls | | |

| | | | |
|--|---|-------------------|---------------|
|  | | | |
| GEV-Nr. | 528916 | Vergl.-Nr. | MOLTUVARUBEVO |
| Beschreibung | Druckfeder ø 10.9mm L 26mm Drahtstärke ø 1.5mm | | |
| Für Modelle: | Evolution-2gr-elettronica-e-puls, Evolution-3gr-elettronica-e-puls, Minimax-Kometa-Elettronica, Minimax-Kometa-Pulsante, Revolution-2gr-elettronica-epuls, Revolution-3gr-elettronica-epuls | | |

| | | | |
|---|---|-------------------|----------|
|  | | | |
| GEV-Nr. | 525202 | Vergl.-Nr. | MOLLVAIN |
| Beschreibung | Druckfeder ø 13.8mm L 54.5mm Drahtstärke ø 1.5mm Windungen 16 | | |
| Für Modelle: | Cubo-2gr-Manuale, Cubo-3gr-Manuale, Cubo-4gr-Manuale, Domobar-Interruttore-Levetta, Domobar-Interruttore-Luminoso, Domobar-Junior-2B, Domobar-Junior-HX, Domobar-Super-2b-Pid-Manuale, Domobar-Super-Manuale, Replica-2gr-manuale-multiboiler, Replica-3gr-manuale-multiboiler, Replica-manuale-2gr, Replica-manuale-3gr, Replica-manuale-4gr | | |

| | | | |
|---|---|-------------------|----------|
|  | | | |
| GEV-Nr. | 527934 | Vergl.-Nr. | MOLLVAER |
| Beschreibung | Druckfeder ø 14.2mm L 45mm Drahtstärke ø 1.5mm CNS | | |
| Für Modelle: | Cubo-2gr-Manuale, Cubo-3gr-Manuale, Cubo-4gr-Manuale, Domobar-Interruttore-Levetta, Domobar-Interruttore-Luminoso, Domobar-Junior-2B, Domobar-Junior-HX, Domobar-Super-2b-Pid-Manuale, Domobar-Super-Manuale, Replica-2gr-manuale-multiboiler, Replica-3gr-manuale-multiboiler, Replica-manuale-2gr, Replica-manuale-3gr, Replica-manuale-4gr | | |

| | | | |
|--|---|-------------------|----------|
|  | | | |
| GEV-Nr. | 526561 | Vergl.-Nr. | MOLLPRGO |
| Beschreibung | Druckfeder ø 14.3mm L 21mm Drahtstärke ø 1.8mm | | |
| Für Modelle: | Cubo-2gr-Manuale, Cubo-3gr-Manuale, Cubo-4gr-Manuale, Domobar-Interruttore-Levetta, Domobar-Interruttore-Luminoso, Domobar-Junior-2B, Domobar-Junior-HX, Domobar-Super-2b-Pid-Manuale, Domobar-Super-Manuale, Replica-2gr-manuale-multiboiler, Replica-3gr-manuale-multiboiler, Replica-manuale-2gr, Replica-manuale-3gr, Replica-manuale-4gr | | |

| | | | |
|--|--|-------------------|--------|
|  | | | |
| GEV-Nr. | 528475 | Vergl.-Nr. | MOLLSC |
| Beschreibung | Druckfeder ø 14.7mm L 33mm Drahtstärke ø 2mm | | |
| Für Modelle: | Cubo-2gr-Elettronico, Cubo-2gr-Manuale, Cubo-3gr-Elettronico, Cubo-3gr-Manuale, Cubo-4gr-Elettronico, Cubo-4gr-Manuale, Domobar-Interruttore-Levetta, Domobar-Interruttore-Luminoso, Domobar-Junior-2B, Domobar-Junior-HX, Domobar-Super-2b-Pid-Manuale, Domobar-Super-Manuale, Minimax-Kometa-Elettronica, Minimax-Kometa-Pulsante, Minimax-Replica-Elettronica, Replica-2gr-manuale-multiboiler, Replica-3gr-manuale-multiboiler, Replica-elettronica-2gr, Replica-elettronica-3gr, Replica-elettronica-4gr, Replica-manuale-2gr, Replica-manuale-3gr, Replica-manuale-4gr, Replica-pulsante-2gr, Replica-pulsante-3gr, Replica-pulsante-4gr | | |

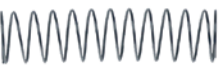
| | | | |
|--|--|-------------------|---|
|  | | | |
| GEV-Nr. | 526474 | Vergl.-Nr. | MOLLCOVANORIT MOLLCOVATNORIT UNK1479865 |
| Beschreibung | Druckfeder ø 8mm L 31.5mm Drahtstärke ø 0.4mm für Expansionsventil | | |
| Für Modelle: | Cubo-2gr-Elettronico, Cubo-2gr-Manuale, Cubo-3gr-Elettronico, Cubo-3gr-Manuale, Cubo-4gr-Elettronico, Cubo-4gr-Manuale, Minimax-Kometa-Elettronica, Minimax-Kometa-Pulsante, Minimax-Replica-Elettronica, Replica-elettronica-2gr, Replica-elettronica-3gr, Replica-elettronica-4gr, Replica-manuale-2gr, Replica-manuale-3gr, Replica-manuale-4gr, Replica-pulsante-2gr, Replica-pulsante-3gr, Replica-pulsante-4gr | | |

Kaffeezubehör

Messlöffel

| | | | |
|---|--|-------------------|----------|
|  | | | |
| 1 | | | |
| GEV-Nr. | 802103 | Vergl.-Nr. | MISURINO |
| Beschreibung | Kaffeelöffel Kaffeemenge 7g Kunststoff | | |
| Für Modelle: | Chimaera, Cubo-2gr-Elettronico, Cubo-2gr-Manuale, Cubo-3gr-Elettronico, Cubo-3gr-Manuale, Cubo-4gr-Elettronico, Cubo-4gr-Manuale, Domobar-Interruttore-Levetta, Domobar-Interruttore-Luminoso, Domobar-Junior-2B, Domobar-Junior-HX, Domobar-Super-2b-Pid-Elettronica, Domobar-Super-2b-Pid-Manuale, Domobar-Super-Elettronica, Domobar-Super-Manuale, Evolution-2gr-elettronica-e-puls, Evolution-3gr-elettronica-e-puls, Lollo-1gruppo, Lollo-2gruppi, Lollo-3gruppi, Minimax-Kometa-Elettronica, Minimax-Kometa-Pulsante, Minimax-Replica-Elettronica, Replica-2gr-elettronica-multiboiler, Replica-2gr-manuale-multiboiler, Replica-3gr-elettronica-multiboiler, Replica-3gr-manuale-multiboiler, Replica-elettronica-2gr, Replica-elettronica-3gr, Replica-elettronica-4gr, Replica-manuale-2gr, Replica-manuale-3gr, Replica-manuale-4gr, Replica-pulsante-2gr, Replica-pulsante-3gr, Replica-pulsante-4gr, Revolution-2gr-elettronica-epuls, Revolution-3gr-elettronica-epuls | | |

Kaffeepulverpressen

| | | | |
|--|--|-------------------|----------|
|  | | | |
| 1 | | | |
| GEV-Nr. | 802104 | Vergl.-Nr. | PRESSINO |
| Beschreibung | Kaffeepresser Kunststoff ø 49/53mm | | |
| Für Modelle: | Chimaera, Cubo-2gr-Elettronico, Cubo-2gr-Manuale, Cubo-3gr-Elettronico, Cubo-3gr-Manuale, Cubo-4gr-Elettronico, Cubo-4gr-Manuale, Domobar-Interruttore-Levetta, Domobar-Interruttore-Luminoso, Domobar-Junior-2B, Domobar-Junior-HX, Domobar-Super-2b-Pid-Elettronica, Domobar-Super-2b-Pid-Manuale, Domobar-Super-Elettronica, Domobar-Super-Manuale, Evolution-2gr-elettronica-e-puls, Evolution-3gr-elettronica-e-puls, Lollo-1gruppo, Lollo-2gruppi, Lollo-3gruppi, Minimax-Kometa-Elettronica, Minimax-Kometa-Pulsante, Minimax-Replica-Elettronica, Replica-2gr-elettronica-multiboiler, Replica-2gr-manuale-multiboiler, Replica-3gr-elettronica-multiboiler, Replica-3gr-manuale-multiboiler, Replica-elettronica-2gr, Replica-elettronica-3gr, Replica-elettronica-4gr, Replica-manuale-2gr, Replica-manuale-3gr, Replica-manuale-4gr, Replica-pulsante-2gr, Replica-pulsante-3gr, Replica-pulsante-4gr, Revolution-2gr-elettronica-epuls, Revolution-3gr-elettronica-epuls | | |

Manometer

| | | | |
|---|---|-------------------|-----|
|  | | | |
| 1 | | | |
| GEV-Nr. | 541233 | Vergl.-Nr. | N/A |
| Beschreibung | Manometer Doppelskala ø 60mm Druckbereich 0-2,5 / 0-15bar Anschluss rückseitig Gewinde 1/8" | | |

| | | | |
|---|---|-------------------|-----|
|  | | | |
| 1 | | | |
| GEV-Nr. | 541287 | Vergl.-Nr. | N/A |
| Beschreibung | Manometer Doppelskala ø 60mm Druckbereich 0-2,5 / 0-15bar Anschluss rückseitig Gewinde 1/8" | | |

| | | | |
|---|---|-------------------|-----|
|  | | | |
| 1 | | | |
| GEV-Nr. | 541410 | Vergl.-Nr. | N/A |
| Beschreibung | Manometer Doppelskala ø 60mm Druckbereich 0-2,5 / 0-15bar Anschluss rückseitig Gewinde 1/8" | | |

| | | | |
|---|---|-------------------|-------------|
|  | | | |
| 1 | | | |
| GEV-Nr. | 541512 | Vergl.-Nr. | MANMDOTNVBM |
| Beschreibung | Manometer Doppelskala ø 60mm Druckbereich 0-2,5 / 0-15bar Anschluss rückseitig Gewinde 1/8" | | |
| Für Modelle: | Minimax-Kometa-Elettronica, Minimax-Kometa-Pulsante | | |

| | | | |
|---|---|-------------------|-----|
|  | | | |
| 1 | | | |
| GEV-Nr. | 541222 | Vergl.-Nr. | N/A |
| Beschreibung | Manometer Doppelskala ø 60mm Druckbereich 0-2,5 / 0-16bar Anschluss rückseitig Gewinde 1/8" | | |

| | | | |
|---|---|-------------------|-----|
|  | | | |
| 1 | | | |
| GEV-Nr. | 541226 | Vergl.-Nr. | N/A |
| Beschreibung | Manometer Doppelskala ø 60mm Druckbereich 0-2,5 / 0-16bar Anschluss rückseitig Gewinde 1/8" | | |

| | | | |
|---|---|-------------------|-----|
|  | | | |
| 1 | | | |
| GEV-Nr. | 541227 | Vergl.-Nr. | N/A |
| Beschreibung | Manometer Doppelskala ø 60mm Druckbereich 0-2,5 / 0-16bar Anschluss rückseitig Gewinde 1/8" | | |

| | | | |
|---|--|-------------------|-----------------------|
|  | | | |
| 1 | | | |
| GEV-Nr. | 541513 | Vergl.-Nr. | MANMKO UNK35164268 |
| Beschreibung | Manometer Doppelskala ø 63mm Druckbereich 0-2,5 / 0-16bar Anschluss rückseitig Gewinde 1/8" | | |
| Für Modelle: | Evolution-2gr-elettronica-e-puls, Evolution-3gr-elettronica-e-puls, Revolution-2gr-elettronica-epuls, Revolution-3gr-elettronica-epuls | | |

| | | | |
|--|---|-------------------|--------------|
|  | | | |
| 1 | | | |
| GEV-Nr. | 541752 | Vergl.-Nr. | MANMDOE40016 |
| Beschreibung | Manometer ø 40mm Druckbereich 0-16bar Gewinde 1/8" Anschluss rückseitig mit Kapillarrohr | | |
| Für Modelle: | Domobar-Junior-2B, Domobar-Junior-HX, Domobar-Super-2b-Pid-Elettronica, Domobar-Super-2b-Pid-Manuale, Domobar-Super-Elettronica, Domobar-Super-Manuale, Minimax-Replica-Elettronica | | |

| | | | |
|---|---|-------------------|--------------|
|  | | | |
| 1 | | | |
| GEV-Nr. | 541751 | Vergl.-Nr. | MANMDOE40025 |
| Beschreibung | Manometer ø 40mm Druckbereich 0-4bar Gewinde 1/8" Anschluss rückseitig mit Kapillarrohr | | |
| Für Modelle: | Domobar-Junior-2B, Domobar-Junior-HX, Domobar-Super-2b-Pid-Elettronica, Domobar-Super-2b-Pid-Manuale, Domobar-Super-Elettronica, Domobar-Super-Manuale, Minimax-Replica-Elettronica | | |

| | | | |
|---|--|-------------------|-------------------------|
|  | | | |
| 1 | | | |
| GEV-Nr. | 541511 | Vergl.-Nr. | MANMSEM MANMSEM42025 |
| Beschreibung | Manometer ø 41mm Druckbereich 0 bis 2,5bar Gewinde 1/8" Markierung 1.1 | | |

| | | | |
|--|--|-------------------|-----------------------------|
|  | | | |
| 1 | | | |
| GEV-Nr. | 541753 | Vergl.-Nr. | MANM49016GHIR UNK1204937 |
| Beschreibung | Manometer ø 50mm Druckbereich 0-16bar Gewinde 1/8" Markierung 8-10 Anschluss rückseitig mit Kapillarrohr | | |
| Für Modelle: | Lollo-2gruppi, Lollo-3gruppi | | |

| | | | |
|--|--|-------------------|-----------------------------|
|  | | | |
| 1 | | | |
| GEV-Nr. | 541756 | Vergl.-Nr. | MANM49016GHI UNK55184468 |
| Beschreibung | Manometer ø 50mm Druckbereich 0-16bar Gewinde 1/8" Markierung 8-10 Anschluss rückseitig mit Kapillarrohr | | |
| Für Modelle: | Evolution-2gr-elettronica-e-puls, Evolution-3gr-elettronica-e-puls, Replica-2gr-elettronica-multiboiler, Replica-2gr-manuale-multiboiler, Replica-3gr-elettronica-multiboiler, Replica-3gr-manuale-multiboiler, Replica-elettronica-2gr, Replica-elettronica-3gr, Replica-elettronica-4gr, Replica-manuale-2gr, Replica-manuale-3gr, Replica-manuale-4gr, Replica-pulsante-2gr, Replica-pulsante-3gr, Replica-pulsante-4gr, Revolution-2gr-elettronica-epuls, Revolution-3gr-elettronica-epuls | | |

| | | | |
|--|--|-------------------|------------------------------|
|  | | | |
| 1 | | | |
| GEV-Nr. | 541755 | Vergl.-Nr. | MANM49025GHIR UNK41655333 |
| Beschreibung | Manometer ø 50mm Druckbereich 0-2,5bar Gewinde 1/8" Markierung 1,3-1,6 Anschluss rückseitig mit Kapillarrohr | | |
| Für Modelle: | Lollo-2gruppi, Lollo-3gruppi | | |

| | | | |
|--|--|-------------------|-----------------------------|
|  | | | |
| 1 | | | |
| GEV-Nr. | 541757 | Vergl.-Nr. | MANM49025GHI UNK29708214 |
| Beschreibung | Manometer ø 50mm Druckbereich 0-2,5bar Gewinde 1/8" Markierung 1,3-1,6 Anschluss rückseitig mit Kapillarrohr | | |
| Für Modelle: | Chimaera, Evolution-2gr-elettronica-e-puls, Evolution-3gr-elettronica-e-puls, Replica-2gr-elettronica-multiboiler, Replica-2gr-manuale-multiboiler, Replica-3gr-elettronica-multiboiler, Replica-3gr-manuale-multiboiler, Replica-elettronica-2gr, Replica-elettronica-3gr, Replica-elettronica-4gr, Replica-manuale-2gr, Replica-manuale-3gr, Replica-manuale-4gr, Replica-pulsante-2gr, Replica-pulsante-3gr, Replica-pulsante-4gr, Revolution-2gr-elettronica-epuls, Revolution-3gr-elettronica-epuls | | |

Werkzeug, Befestigungsmaterialien, Verbrauchsgüter

Befestigungsmaterialien

Schrauben

Sechskantschrauben

| | | | |
|---|--|-------------------|----------------------------|
|  | | | |
| 1 | | | |
| GEV-Nr. | 506175 | Vergl.-Nr. | UNK79513711 VITETEM8X14 |
| Beschreibung | Sechskantschraube Gewinde M8 Gewinde L 14mm CNS SW 13 VPE 20 Stück Kopfstärke 3mm DIN 933 / ISO 4017 | | |
| Für Modelle: | Chimaera, Cubo-2gr-Elettronico, Cubo-2gr-Manuale, Cubo-3gr-Elettronico, Cubo-3gr-Manuale, Cubo-4gr-Elettronico, Cubo-4gr-Manuale, Domobar-Interruttore-Levetta, Domobar-Interruttore-Luminoso, Domobar-Junior-2B, Domobar-Junior-HX, Domobar-Super-2b-Pid-Elettronica, Domobar-Super-2b-Pid-Manuale, Domobar-Super-Elettronica, Domobar-Super-Manuale, Evolution-2gr-elettronica-e-puls, Evolution-3gr-elettronica-e-puls, Lollo-1gruppo, Lollo-2gruppi, Lollo-3gruppi, Minimax-Kometa-Elettronica, Minimax-Kometa-Pulsante, Minimax-Replica-Elettronica, Replica-2gr-elettronica-multiboiler, Replica-2gr-manuale-multiboiler, Replica-3gr-elettronica-multiboiler, Replica-3gr-manuale-multiboiler, Replica-elettronica-2gr, Replica-elettronica-3gr, Replica-elettronica-4gr, Replica-manuale-2gr, Replica-manuale-3gr, Replica-manuale-4gr, Replica-pulsante-2gr, Replica-pulsante-3gr, Replica-pulsante-4gr, Revolution-2gr-elettronica-epuls, Revolution-3gr-elettronica-epuls | | |

Zylinderkopfschrauben

DIN 912/ISO 4762

| | | | |
|---|---|-------------------|-----------|
|  | | | |
| 1 | | | |
| GEV-Nr. | 560373 | Vergl.-Nr. | VITEVITBR |
| Beschreibung | Zylinderkopfschraube Gewinde M4 Gewinde L 12mm SW 3 CNS VPE 1 Stück Aufnahme Innensechskant DIN 912/ISO 4762 | | |
| Für Modelle: | Chimaera, Cubo-2gr-Elettronico, Cubo-3gr-Elettronico, Cubo-4gr-Elettronico, Domobar-Super-2b-Pid-Elettronica, Domobar-Super-Elettronica, Evolution-2gr-elettronica-e-puls, Evolution-3gr-elettronica-e-puls, Lollo-1gruppo, Lollo-2gruppi, Lollo-3gruppi, Minimax-Kometa-Elettronica, Minimax-Kometa-Pulsante, Minimax-Replica-Elettronica, Replica-2gr-elettronica-multiboiler, Replica-3gr-elettronica-multiboiler, Replica-elettronica-2gr, Replica-elettronica-3gr, Replica-elettronica-4gr, Replica-pulsante-2gr, Replica-pulsante-3gr, Replica-pulsante-4gr, Revolution-2gr-elettronica-epuls, Revolution-3gr-elettronica-epuls | | |

| | | | |
|---|--|-------------------|-----------|
|  | | | |
| 1 | | | |
| GEV-Nr. | 560031 | Vergl.-Nr. | VITEBR6MA |
| Beschreibung | Zylinderkopfschraube Gewinde M6 Gewinde L 10mm SW 5 CNS VPE 20 Stück DIN 912/ISO 4762 | | |
| Für Modelle: | Chimaera, Cubo-2gr-Elettronico, Cubo-2gr-Manuale, Cubo-3gr-Elettronico, Cubo-3gr-Manuale, Cubo-4gr-Elettronico, Cubo-4gr-Manuale, Domobar-Interruttore-Levetta, Domobar-Interruttore-Luminoso, Domobar-Junior-2B, Domobar-Junior-HX, Domobar-Super-2b-Pid-Elettronica, Domobar-Super-2b-Pid-Manuale, Domobar-Super-Elettronica, Domobar-Super-Manuale, Minimax-Replica-Elettronica, Replica-2gr-elettronica-multiboiler, Replica-2gr-manuale-multiboiler, Replica-3gr-elettronica-multiboiler, Replica-3gr-manuale-multiboiler, Replica-elettronica-2gr, Replica-elettronica-3gr, Replica-elettronica-4gr, Replica-manuale-2gr, Replica-manuale-3gr, Replica-manuale-4gr, Replica-pulsante-2gr, Replica-pulsante-3gr, Replica-pulsante-4gr, Revolution-2gr-elettronica-epuls, Revolution-3gr-elettronica-epuls | | |



| | | | |
|---------------------|--|-------------------|-------------|
| GEV-Nr. | 527170 | Vergl.-Nr. | VITEBR6MACO |
| Beschreibung | Zylinderkopfschraube Gewinde M6 Gewinde L 8mm SW 5 CNS VPE 1 Stück DIN 912/ISO 4762 | | |
| Für Modelle: | Chimaera, Cubo-2gr-Elettronico, Cubo-2gr-Manuale, Cubo-3gr-Elettronico, Cubo-3gr-Manuale, Cubo-4gr-Elettronico, Cubo-4gr-Manuale, Domobar-Interruttore-Levetta, Domobar-Interruttore-Luminoso, Domobar-Junior-2B, Domobar-Junior-HX, Domobar-Super-2b-Pid-Elettronica, Domobar-Super-2b-Pid-Manuale, Domobar-Super-Elettronica, Domobar-Super-Manuale, Evolution-2gr-elettronica-e-puls, Evolution-3gr-elettronica-e-puls, Lollo-1gruppo, Lollo-2gruppi, Lollo-3gruppi, Minimax-Kometa-Elettronica, Minimax-Kometa-Pulsante, Minimax-Replica-Elettronica, Replica-2gr-elettronica-multiboiler, Replica-2gr-manuale-multiboiler, Replica-3gr-elettronica-multiboiler, Replica-3gr-manuale-multiboiler, Replica-elettronica-2gr, Replica-elettronica-3gr, Replica-elettronica-4gr, Replica-manuale-2gr, Replica-manuale-3gr, Replica-manuale-4gr, Replica-pulsante-2gr, Replica-pulsante-3gr, Replica-pulsante-4gr, Revolution-2gr-elettronica-epuls, Revolution-3gr-elettronica-epuls | | |

Muttern

Hutmutter

| | | | |
|--|---|-------------------|---------------|
|  | | | |
| 1 | | | |
| GEV-Nr. | 560137 | Vergl.-Nr. | VITEDACE6MAIN |
| Beschreibung | Hutmutter Gewinde M6 SW 10 CNS VPE 20 Stück DIN/ISO DIN 1587 | | |
| Für Modelle: | Cubo-2gr-Manuale, Cubo-3gr-Manuale, Cubo-4gr-Manuale, Domobar-Interruttore-Levetta, Domobar-Interruttore-Luminoso, Domobar-Junior-2B, Domobar-Junior-HX, Domobar-Super-2b-Pid-Manuale, Domobar-Super-Manuale, Replica-2gr-manuale-multiboiler, Replica-3gr-manuale-multiboiler, Replica-manuale-2gr, Replica-manuale-3gr, Replica-manuale-4gr | | |

Befestigungen

Splinte

| | | | |
|--|---|-------------------|---------------|
|  | | | |
| 1 | | | |
| GEV-Nr. | 695209 | Vergl.-Nr. | COPPASTRUBEVO |
| Beschreibung | Splint ø2mm L 20mm CNS | | |
| Für Modelle: | Evolution-2gr-elettronica-e-puls, Evolution-3gr-elettronica-e-puls, Minimax-Kometa-Elettronica, Minimax-Kometa-Pulsante, Revolution-2gr-elettronica-epuls, Revolution-3gr-elettronica-epuls | | |

| | | | |
|--------------------------------|------|------------------------|----|
| A | | S | |
| Anlege-Sicherheitsthermostate | 4 | Schalter und Taster | 5 |
| Anlegethermostate | 4, 4 | Schrauben | 34 |
| B | | Schütze | 8 |
| Befestigungen | 34 | Sechskantschrauben | 34 |
| Befestigungsmaterialien | 34 | Signallampen | 7 |
| Betriebskondensatoren | 15 | Signallampen komplett | 8 |
| D | | Splinte | 34 |
| Dichtscheiben | 30 | Systemschalter ROLD | 6 |
| Dichtungsringe | 29 | T | |
| Drehschalter | 7 | Thermostate | 4 |
| Druckschalter/-taster | 5 | Transformatoren | 9 |
| Drucksteigerungspumpen II | 14 | V | |
| F | | Vibrationspumpen | 15 |
| Flowmeter | 13 | W | |
| Fühler | 9 | Wippenschalter/-taster | 5 |
| H | | Z | |
| Hebelschalter | 6 | Zylinderkopfschrauben | 34 |
| Heizkörper | 3 | | |
| Heizkörper für Kaffeemaschinen | 3 | | |
| Hutmuttern | 34 | | |
| K | | | |
| Kaffeepulverpressen | 32 | | |
| Kondensatoren & EntstörfILTER | 15 | | |
| L | | | |
| Lampen | 7 | | |
| LEDs | 8 | | |
| Leistungshalbleiter | 8 | | |
| M | | | |
| Magnetventile | 12 | | |
| Messlöffel | 32 | | |
| Mikroschalter | 6 | | |
| Muttern | 34 | | |
| O | | | |
| O-Ringe | 28 | | |
| P | | | |
| Pressostate | 13 | | |
| Pumpen | 14 | | |
| R | | | |
| Relais | 8 | | |