



COMPONENTES GAS



COMPONENTES ELÉCTRICOS



TECNOLOGÍA DEL AGUA



COMPONENTES MECÁNICOS



HERRAMIENTAS

Repuestos adaptables a

VIRTUS

Encuentre nuestra gama siempre actualizada en la tienda online de GEV



Catálogo de fabricantes

Las piezas de repuesto y accesorios más importantes de cada fabricante reunidas y ordenadas de manera práctica

- ✓ En la tienda online GEV encontrará el surtido completo y toda la información actualizada de máquinas y aparatos
- ✓ Índice alfabético al final del catálogo

Tienda online GEV

www.gev-online.es
www.gev-online.com



- 🔍 marcar artículos como favoritos
- 🔍 acceso mediante su e-mail y su contraseña habitual
- 🔍 ponga en la cesta de la compra, múltiples artículos a la vez
- 🔍 búsqueda de artículos inmediata sin necesidad conectarse

resistencias

resistencias para hornos

			
código	420111	referencia	965.060.00
descripción	resistencia 1500W 230V espirales 1 L 555mm An 210mm L1 70mm L2 485mm B1 88mm B2 33mm longitud brida 70mm anchura brida 22mm dist. del agujero 56mm agujero ø 5mm tubo ø 8,5mm empalme conector Faston 6,3mm longitud de empalme 17mm espirales 3 brida de empalme resistencia seca para horno		
Para modelos:	VS70120CFGE, VS7080CFE, VS7080CFEQ, VS7080CFGE, VS7080CFVE, VS7080TPFE, VS90120CFGE, VS90160CFGE, VS9080CFES, VS9080CFGE, VS9080CFVE, VS9080TPFE		

resistencias para baño maría

			
código	415927	referencia	665.004.00
descripción	resistencia 1200W 240V espirales 1 L 405mm An 88mm H 32mm longitud de lengüeta 40mm anchura de lengüeta 18mm resistencia seca dist. del agujero 44mm empalme M5 lengüeta de sujeción rosca de sujeción M5		
Para modelos:	VS7080BMET, VS7080BMFEP		

			
código	416538	referencia	965.002.00
descripción	resistencia 1470W 230V espirales 1 L 528mm An 95mm H 30mm longitud de lengüeta 40mm anchura de lengüeta 19mm tubo ø 8,5mm resistencia seca dist. del agujero 46mm empalme M5 lengüeta de sujeción longitud de empalme 34mm agujero ø 5mm baño-maría		
Para modelos:	VS9080BMET, VS9080BMFEP		

			
código	415926	referencia	665.003.00
descripción	resistencia 1800W 240V espirales 1 L 403mm An 128mm H 32mm longitud de lengüeta 40mm anchura de lengüeta 18mm tubo ø 8,5mm resistencia seca dist. del agujero 80mm lengüeta de sujeción rosca de sujeción M5		
Para modelos:	VS7040BMET, VS7040BMFEP		

			
código	416537	referencia	965.001.00
descripción	resistencia 2200W 230V espirales 1 L 523mm An 134mm H 32mm longitud de lengüeta 40mm anchura de lengüeta 18mm tubo ø 9mm resistencia seca dist. del agujero 79mm empalme M5 lengüeta de sujeción longitud de empalme 30mm rosca de sujeción M5 baño maría		
Para modelos:	VS9040BMET, VS9040BMFEP		

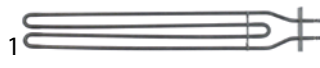
			
código	417724	referencia	965.062.00
descripción	resistencia 2500W 230V espirales 1 L 630mm An 90mm longitud brida 100mm anchura brida 35mm dist. del agujero 88mm empalme M5 tubo ø 8,5mm brida rectangular agujero ø 6mm resistencia de inmersión baño maría		
Para modelos:	VS9040GRACQE, VS9080GRACQE		

resistencias para freidora

empalme excéntrico

con rosca

			
código	420482	referencia	665.101.00
descripción	resistencia 12000W 230V espirales 3 L 315mm An 175mm H 32mm longitud pletina 26mm pletina ø2 62mm racor termostato M10x1 casquillo portasondas 2 casquillo termostato arriba/abajo L1 15mm L2 300mm B1 30mm B2 33mm para O.R ø 51/56mm tubo ø 8,5mm longitud del cable 515mm empalme cable		
Para modelos:	VS7040FRE17X, VS7080FRE17X, VS9040FRE17, VS9080FRE17		

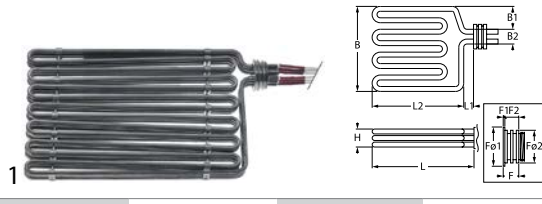
			
código	420560	referencia	965.065.00
descripción	resistencia 20000W 400V espirales 3 L 425mm An 255mm H 35mm longitud pletina 19mm pletina ø2 62mm pletina ø2 57mm L1 21mm L2 408mm B2 34mm rosca M54x1,5 tubo ø 8,5mm longitud del cable 510mm freidora		
Para modelos:	VS7040FRE17X, VS7080FRE17X, VS9040FRE17, VS9040FRE21, VS9080FRE17, VS9080FRE21		

sujeción 2 orificios

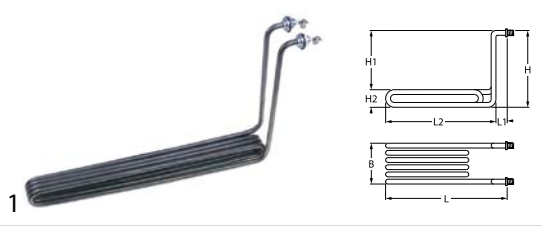
			
código	419031	referencia	965.009.00
descripción	resistencia 3400/3700W 230/240V espirales 1 L 405mm An 44mm H 228mm L1 25mm L2 380mm H1 192mm H2 36mm rosca M14x1,5 distancia de sujeción 36mm tubo ø 8,5mm sujeción 2 orificios empalme M5 resistencia de inmersión espirales 4 freidora		
Para modelos:	VS9040FRE15, VS9080FRE15		



resistencias para plancha grills



código	417736	referencia	665.095.00 665.095.12
descripción	resistencia 1800W 230V espirales 1 L 470mm An 95mm H 95mm tubo ø 8.5mm empalme M4		
Para modelos:	V080FTREVCRT, V7040FTREVCRT, VS7040FTET, VS7040FTEVCRT, VS7040FTEVT, VS7040FTRET, VS7040FTREV, VS7080FTET, VS7080FTEVCRT, VS7080FTEVT, VS7080FTRET, VS7080FTREV, VS7080FTRRET, VS7080FTRREVC, VS7080FTRREV		



código	420105	referencia	665.102.00
descripción	resistencia 2000W 230V espirales 1 L 480mm An 90mm H 42mm tubo ø 8.5mm IRCA L1 50mm L2 430mm B1 49mm B2 20mm brida de empalme empalme M5 dist. del agujero 89mm longitud brida 100mm anchura brida 35mm agujero ø 6mm espirales 2 resistencia seca		
Para modelos:	VS7040GRACQE, VS7080GRACQE		



código	417735	referencia	965.059.12
descripción	resistencia 2500W 230V espirales 1 L 610mm An 80mm H 95mm tubo ø 8.5mm empalme M4		
Para modelos:	V9040FTREVCRT, V9080FTREVCRT, V9080FTRRECR, VS9040FTECRT, VS9040FTET, VS9040FTEVCRT, VS9040FTEVT, VS9040FTRCR, VS9040FTRET, VS9040FTREV, VS9080FTECRT, VS9080FTET, VS9080FTEVCRT, VS9080FTEVT, VS9080FTRCR, VS9080FTRET, VS9080FTREV, VS9080FTRRET, VS9080FTRREVC, VS9080FTRREV		

resistencias para refrigeración

resistencias de descongelación



código	419195	referencia	B00REZ116
descripción	resistencia 2x100W 2x115V L 380mm Anmm longitud del cable 1500mm tubo ø 8.5mm descongelación		
Para modelos:	BMA0008-F, BMA0010-F, BNA0036-F, BNA0037-F, BNA0045-F, BNA0052-F, BNA0053-F, BNA0054-F, BNA0055-F, BNA0057-F, BNA0064-F, BNA0065-F, BNA0066-F, CCZ0036-F, CCZ0037-F		

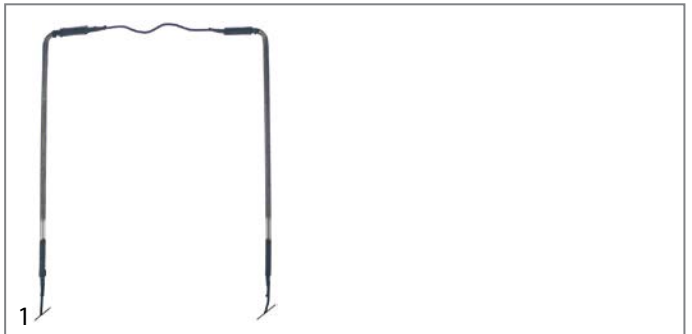

código	419197	referencia	B00REZ111
descripción	resistencia 2x200W 2x110V L 400mm Anmm longitud del cable 1500mm tubo ø 8.5mm descongelación		
Para modelos:	BMB0035-F, BMB0036-F, BMB0037-F, BNB0010-F, BNB0011-F, BNB0012-F, BNB0013-F, BNB0014-F, BNB0015-F, BNZ0007-F, PB9RI-F, VTGB4A-F		



código	419196	referencia	B00REZ100
descripción	resistencia 55W 220V L 410mm An 50mm H 80mm longitud del cable 1600mm tubo ø 8.5mm descongelación		
Para modelos:	BMB0035-F, BMB0036-F, BMB0037-F, BNA0030-F, BNA0031-F, BNA0036-F, BNA0044-F, BNA0056-F, BNZ0002-F, BNZ0004-F, BNZ0006-F, BNZ0008-F, CCZ0036-F, CCZ0037-F, PB9RI-F, VTGB2A-F, VTGB2-F, VTGB3A-F, VTGB3-F, VTGB4-F		

resistencias para sartenes basculantes



código	417726	referencia	665.110.00
descripción	resistencia sartén basculante 3330W 230V L 385mm An 220mm H 35mm empalme M4 resistencia seca espirales 1 tubo ø 8.5mm		
Para modelos:	VS7080BREI, VS7080BREIM		

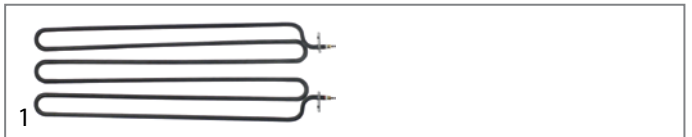

código	417725	referencia	965.073.00
descripción	resistencia sartén basculante 5000W 230V L 550mm An 190mm H 25mm empalme M4 resistencia seca espirales 1 tubo ø 8.5mm		
Para modelos:	VS9080BREI, VS9080BREIM		

resistencias para cuecepasta



código	419247	referencia	665.103.00
descripción	resistencia 4500W 230V espirales 3 L 350mm empalme conector Faston 6,3mm tubo ø 6.3mm brida ø 72mm ø casquillo portasondas 8.5mm longitud casquillo portasondas 200mm resistencia de inmersión		
Para modelos:	VS9040CPES, VS9080CPES		

resistencias para formadoras de pizzas

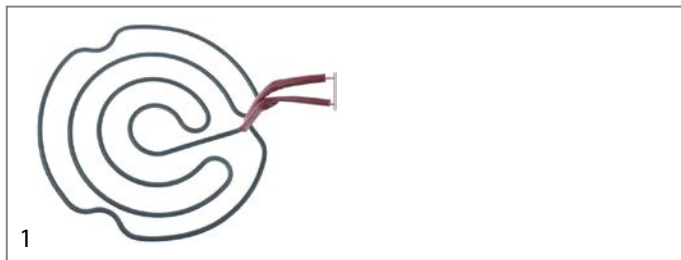

código	418047	referencia	91711080
descripción	resistencia 1600W 230V L 300mm Anmm espirales 1 longitud del cable 1450mm longitud de empalme 30mm resistencia seca tubo ø 6.3mm ø ext. 300		
Para modelos:	CBC0003		

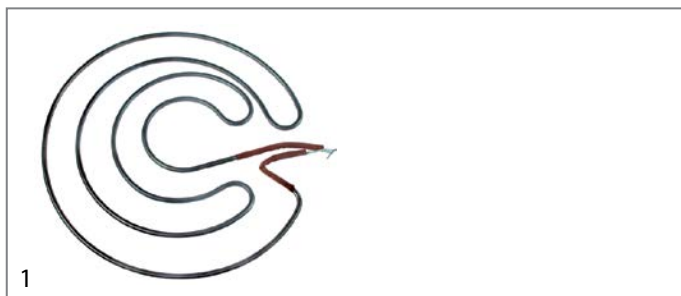

código	418048	referencia	91711081
descripción	resistencia 1790W 208V espirales 1 longitud del cable 1350mm tubo ø 6.3mm ø ext. 300 distancia de empalme 50mm		
Para modelos:	CBC0001		

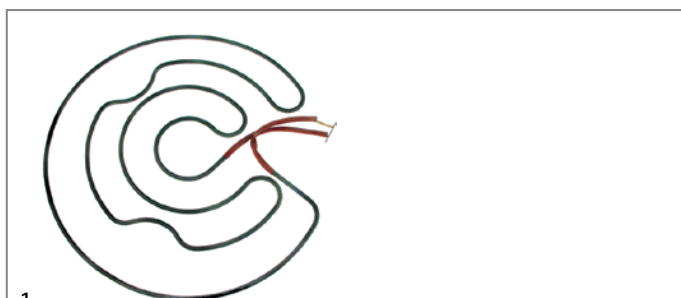

código	418049	referencia	91711082
descripción	resistencia 2200W 220V espirales 1 longitud del cable 1480mm resistencia seca tubo ø 6.3mm ø ext. 385 distancia de empalme 38mm		
Para modelos:	CBC0004		

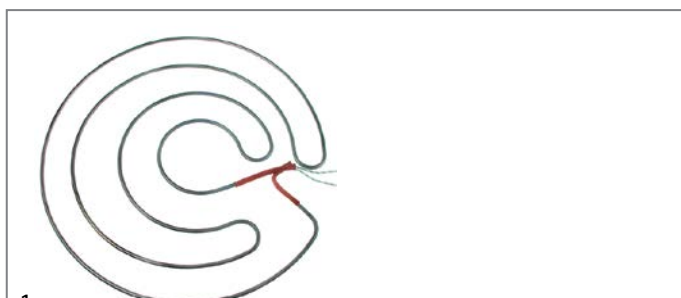

código	418051	referencia	91711084
descripción	resistencia 2900/3200W 208/230V longitud del cable 1400mm resistencia seca tubo ø 6.3mm ø ext. 475		
Para modelos:	CBC0002		

resistencias secas para lavavajillas



código	420561	referencia	12048965
descripción	resistencia 2800W 230V espirales 1 L 325mm An 55mm H 40mm tubo ø 6.5mm empalme F6,3x0,8 resistencia seca lavavajillas		
Para modelos:	GLB0067-F, GLB0069-F		

cables de calefacción

cables de calefacción para desagües



código	381244	referencia	B00REZ104
descripción	cable de calefacción para desagüe 40W 220V 50Hz L 2000mm L1 (sin calentam.) 1000mm L2 (con calentam.) 1000mm ø cable 5mm empalme de dos hilos		
Para modelos:	BNZ0007-F, VTGB4A-F		



código	381250	referencia	B00REZ103
descripción	cable de calefacción para desagüe 80W 220V ø 5.5mm L 3000mm L1 (sin calentam.) 950mm L2 (con calentam.) 2050mm rosca sonda ø 8x7mm goma sonda L 42mm cable silicona resistencia a +20°C 0.6kOhm colores cable gris longitud de cable 3m de dos hilos		
Para modelos:	BMB0030-F, BMC0012-F, BMC0014-F, BMC0016-F		

empalme ambos lados

con casquillos terminales de cable



código	381402	referencia	B00REZ112
descripción	cable de calefacción 37W 220V 50Hz L 7000mm L1 (sin calentam.) 300mm L2 (con calentam.) 6700mm ø cable 3mm		
Para modelos:	BNB0012-F, BNB0013-F		



código	419220	referencia	B00REZ113
descripción	cable de calefacción 37W 220V L 9000mm L1 (sin calentam.) 740mm L2 (con calentam.) 8260mm tejido de fibra de vidrio recubierto de silicona ø 3mm empalme terminal de cable		
Para modelos:	BNB0014-F, BNB0015-F, VTGB4A-F		

cartuchos calentadores



código	419212	referencia	B00REZ106
descripción	cartucho calentador 190W 230V ø 12mm L 180mm rosca 3/8" longitud del cable 1000mm		
Para modelos:	BMA0021-F, BMA0022-F, BMA0024-F, BMA0025-F, BMA0029-F, BMB0030-F, BMC0012-F, BMC0014-F, BMC0016-F		





radiadores cerámicos

245x60mm



1

código	415104	referencia	665.010.00
descripción	radiador cerámico 1000W 230V cable cables perlizados L 245mm An 60mm H 35mm		
Para modelos:	VS7040SPET, VS9040SPET		
repuestos para	415104		
	código	415109	referencia —
			resorte de fijación
accesorios para	415104		
	código	415110	referencia —
			reflector L 245mm An 95mm H 31mm espesor 0.75mm agujero ø 15x40mm

resistencias de tubo de aletas



1



código	420330	referencia	927132
descripción	resistencia 2000W 240V L 454mm An 210mm ø 27.5mm rosca M14x1 empalme M4 para secado sistemas de lavado espirales 1 sujeción 2 orificios		
Para modelos:	GLB0045, GLB0047, GLB0048, GLB0049, GLB0050, GLB0051		

resistencias de inmersión

brida 3 orificios ø 47,5mm







1

código	416240	referencia	230083C
descripción	resistencia 6545W 230/400V montaje ø 48mm espirales 3 L 355mm An 31mm H 37mm casquillo portasondas 1 ø casquillo portasondas 7mm longitud casquillo portasondas 175mm casquillo termostato arriba centrado no ajustado tubo ø 6.5mm dist. del agujero 63mm agujero ø 10mm empalme M4 brida 3 orificios resistencia de inmersión		
Para modelos:	GLB0040, GLB0041, GLB0042, GLB0043C, GLB0044C, GLB0049, GLB0050, GLB0051		
accesorios para	416240		
	código	510408	referencia 456002
			junta tórica EPDM espesor 5.34mm int.ø 47mm UE 1 pzs
	código	510562	referencia —
			junta tórica silicona espesor 5.34mm int.ø 47mm UE 1 pzs



1

código	416241	referencia	230020C
descripción	resistencia 8000W 230V montaje ø 47.5mm espirales 3 L 355mm An 35mm H 35mm casquillo portasondas 1 ø casquillo portasondas 7.5mm longitud casquillo portasondas 185mm casquillo termostato no ajustado tubo ø 6.3mm dist. del agujero 64mm agujero ø 8mm empalme M4 brida 3 orificios resistencia de inmersión		
Para modelos:	GLB0043C, GLB0043C-60Hz, GLB0045, GLB0047, GLB0048, GLB0049, GLB0050, GLB0051		
repuestos para	416241		
	código	510408	referencia 456002
			junta tórica EPDM espesor 5.34mm int.ø 47mm UE 1 pzs
accesorios para	416241		
	código	510093	referencia 467002 69870
			tapa de protección
	código	510408	referencia 456002
			junta tórica EPDM espesor 5.34mm int.ø 47mm UE 1 pzs
	código	510562	referencia —
			junta tórica silicona espesor 5.34mm int.ø 47mm UE 1 pzs



1

código	416242	referencia	80398C
descripción	resistencia 9500W 230V montaje ø 47.5mm espirales 3 L 330mm An 35mm H 35mm casquillo portasondas 1 ø casquillo portasondas 7mm longitud casquillo portasondas 175mm casquillo termostato descentrado, no ceñido tubo ø 8.5mm dist. del agujero 72mm agujero ø 8/10mm empalme M4 brida 3 orificios resistencia de inmersión		
Para modelos:	GLB0044C, GLB0047, GLB0048, GLB0051		
repuestos para	416242		
	código	510408	referencia 456002
			junta tórica EPDM espesor 5.34mm int.ø 47mm UE 1 pzs

brida 3 orificios ø 57,5mm



1

código	417738	referencia	965.068.00
descripción	resistencia 10500W 230V montaje ø 57.5mm espirales 3 L 575mm An 30mm H 40mm tubo ø 8.5mm dist. del agujero 75mm agujero ø 8/10mm longitud del cable 700mm empalme cable brida 3 orificios marmita		
Para modelos:	VS9080PEI150		

con brida redonda \varnothing 57,5mm



código	416662	referencia	665.022.00
descripción	resistencia 6000W 230V espirales 3 L 405mm An 31mm H 46mm tubo \varnothing 6.3mm \varnothing casquillo portasondas 7.5mm longitud casquillo portasondas 270mm casquillo portasondas 1 casquillo termostato descentrado, ceñido empalme conector Faston 6,3mm resistencia de inmersión brida redonda montaje \varnothing 57.5mm		
Para modelos:	VS7080PEI50		
repuestos para	416662		
	código	510409	referencia —
	junta tórica EPDM espesor 5.34mm int. \varnothing 56.52mm UE 1 pzs		
accesorios para	416662		
	código	520235	referencia —
	brida tres orificios dist. del agujero 70.5mm \varnothing perforación 6.5mm int. \varnothing 53.5mm		
	código	550002	referencia —
	estribo de fijación H 10mm L 21mm An 10mm agujero \varnothing 6.5mm para resistencia		

con brida redonda otros





código	419247	referencia	665.103.00
descripción	resistencia 4500W 230V espirales 3 L 350mm empalme conector Faston 6,3mm tubo \varnothing 6.3mm brida \varnothing 72mm \varnothing casquillo portasondas 8.5mm longitud casquillo portasondas 200mm resistencia de inmersión		
Para modelos:	VS9040CPES, VS9080CPES		

otros





código	420362	referencia	12024747
descripción	resistencia 9000W 230V espirales 3 L 280mm An 77mm H 29mm brida dist. del agujero 47.5mm agujero \varnothing 6mm empalme conector Faston 6,3mm tubo \varnothing 8.5mm longitud brida 105mm anchura brida 60mm resistencia de inmersión		
Para modelos:	AIC0039-F, AIC0041-F, AIC0043-F, AIC0045-F		
accesorios para	420362		
	código	550994	referencia 12023680
	junta L 105mm An 60mm espesor 3mm para resistencia		







código	417197	referencia	12024752
descripción	resistencia 9000W 230V espirales 3 L 280mm An 78mm H 35mm dist. del agujero 48mm agujero \varnothing 6mm tubo \varnothing 8.5mm longitud brida 105mm anchura brida 60mm resistencia de inmersión \varnothing casquillo portasondas 3mm casquillo portasondas 1 longitud casquillo portasondas 115mm		
Para modelos:	AIC0037-F, AIC0039-F, AIC0041-F, AIC0043-F, AIC0045-F		
accesorios para	417197		
	código	550994	referencia 12023680
	junta L 105mm An 60mm espesor 3mm para resistencia		

1"



código	420074	referencia	965.066.00
descripción	resistencia 260W 230V espirales 1 L 242mm An 18mm H 6.25mm tubo \varnothing 6.25mm \varnothing casquillo portasondas 5mm longitud casquillo portasondas 230mm casquillo portasondas 1 casquillo termostato centrado, ajustado empalme conector Faston 6,3mm longitud de empalme 35mm resistencia de inmersión brida rosca EC 32 rosca 1"		
Para modelos:	VS7080PEI50, VS7080PGI50, VS9080PEI150, VS9080PGI150		
repuestos para	420074		
	código	503158	referencia —
	junta plana FIBER \varnothing ext. 44mm int. \varnothing 33mm espesor 2mm UE 1 pzs		
accesorios para	420074		
	código	507532	referencia —
	tuerca rosca 1" H 10mm EC 40 latón UE 1 pzs		



código	416235	referencia	70562 80360
descripción	resistencia 3000W 230V espirales 1 L 320mm An 50mm H 40mm rosca M10x1 distancia de sujeción 44mm tubo \varnothing 6.3mm empalme conector Faston 6,3mm sujeción 2 orificios L1 32mm L2 288mm		
Para modelos:	GLB0040, GLB0041		
repuestos para	416235		
	código	510893	referencia —
	junta tórica EPDM espesor 2.62mm int. \varnothing 9.92mm UE 1 pzs		
accesorios para	416235		
	código	510416	referencia —
	junta plana fibra \varnothing ext. 19mm int. \varnothing 10.5mm espesor 1.5mm para rosca M10 UE 1 pzs		
	código	510893	referencia —
	junta tórica EPDM espesor 2.62mm int. \varnothing 9.92mm UE 1 pzs		
	código	521129	referencia —
	tuerca rosca M10 H 6mm inox EC 17 UE 1 pzs DIN/ISO DIN 439		

Continúa en la página siguiente



accesorios para	416235			
	código	560192	referencia	—
	arandela dentada int.ø 10.4mm ø ext. 18mm inox DIN/ISO DIN 6798A UE 1 pzs para rosca M10			

	1		
código	420334	referencia	41211
descripción	resistencia 3000W 230V espirales 1 L 380mm An 87mm H 26mm rosca M10x1 distancia de sujeción 81mm tubo ø 6.3mm empalme M4 resistencia de inmersión sujeción 2 orificios		
Para modelos:	GLB0041, GLB0042		

resistencias circulación de aire

	1		
código	419270	referencia	12024349
descripción	resistencia 15000W 230V espirales 3 int.ø 540mm ø ext. 560mm L 580mm H 148mm B1 160mm H1 16mm H2 132mm longitud brida 210mm anchura brida 30mm dist. del agujero 180mm empalme M4 tubo ø 10mm rosca de sujeción M6		
Para modelos:	AIC0041-F, AIC0045-F, AIC0073-F, AIC0075-F		

	1		
código	419271	referencia	12024359
descripción	resistencia 15000W 230V espirales 3 int.ø 620mm ø ext. 640mm L 660mm H 152mm B1 160mm H1 20mm H2 132mm longitud brida 210mm anchura brida 30mm dist. del agujero 180mm empalme M4 tubo ø 10mm rosca de sujeción M6		
Para modelos:	AIC0041-F, AIC0045-F, AIC0073-F, AIC0075-F		

	1			
código	419268	referencia	12039496	
descripción	resistencia 9000W 230V espirales 3 int.ø 410mm ø ext. 417mm L 450mm H 100mm L1 15mm B1 105mm H1 80mm H2 20mm longitud brida 142mm anchura brida 25mm distancia de sujeción 125mm empalme M4 tubo ø 8.5mm rosca de sujeción M6			
Para modelos:	AIC0037-F, AIC0039-F, AIC0043-F, AIC0071-F, AIC0072-F, AIC0074-F			
accesorios para	419268			
	código	521284	referencia	12041165
	junta para resistencia L 142mm An 25mm espesor 2mm grafito			

	1		
código	419269	referencia	12039497
descripción	resistencia 9000W 230V espirales 3 int.ø 490mm ø ext. 507mm L 53mm H 100mm L1 14mm B1 100mm H1 83mm H2 17mm longitud brida 142mm anchura brida 25mm distancia de sujeción 125mm empalme M4 tubo ø 8.5mm rosca de sujeción M6		
Para modelos:	AIC0039-F, AIC0043-F, AIC0072-F, AIC0074-F		

resistencias radiantes

	1			
código	490079	referencia	965.041.00	
descripción	resistencia radiante octogonal 3400W 230V L 300mm An 300mm espirales 2 H 30mm con resistencia en espiral regulación de energía con avisador de temperatura empalmes 4+2 tipo de empalme cable AD			
Para modelos:	VS9040PVET, VS9080CFVE, VS9080PVET, VS9080TPET, VS9080TPFE			
repuestos para	490079			
	código	390931	referencia	—
	termostato de seguridad para resistencia radiante			





			
1			
código	490222	referencia	965.069.00
descripción	resistencia radiante octogonal 3400W 230V L 300mm An 300mm espirales 2 H 35mm con resistencia en espiral regulación de energía con avisador de temperatura		
Para modelos:	VS9040PVET, VS9080CFVE, VS9080PVET		

arandelas			
			
1			
código	560111	referencia	12009987
descripción	arandela int.ø 4.3mm ø ext. 9mm espesor 0.8mm inox UE 20 pzs DIN 125A para rosca M4		
Para modelos:	AIC0037-F, AIC0038-F, AIC0039-F, AIC0040-F, AIC0041-F, AIC0042-F, AIC0043-F, AIC0044-F, AIC0045-F, AIC0046-F, AIC0071-F, AIC0072-F, AIC0073-F, AIC0074-F, AIC0075-F, AIC0076-F, AIC0077-F, AIC0078-F, AIC0079-F, AIC0080-F		

a 2 circuitos			
			
1			
código	490118	referencia	665.052.00
descripción	resistencia radiante ø 250mm 2500W espirales 2 potencia parcial 1000W		
Para modelos:	VS7080CFVE, VS7080PVET, VS7080TPET, VS7080TPFE		

			
1			
código	560112	referencia	12009944
descripción	arandela int.ø 5.3mm ø ext. 10mm espesor 1mm inox UE 20 pzs DIN 125A para rosca M5		
Para modelos:	AIC0037-F, AIC0038-F, AIC0039-F, AIC0040-F, AIC0041-F, AIC0042-F, AIC0043-F, AIC0044-F, AIC0045-F, AIC0046-F, AIC0071-F, AIC0072-F, AIC0073-F, AIC0074-F, AIC0075-F, AIC0076-F, AIC0077-F, AIC0078-F, AIC0079-F, AIC0080-F		

accesorios			
tuercas hexagonales			
			
1			
código	560131	referencia	12009839
descripción	tuerca hexagonal rosca M4 H 3.2mm EC 7 inox DIN/ISO DIN 934 / ISO 4032/8673 UE 20 pzs		
Para modelos:	AIC0037-F, AIC0038-F, AIC0039-F, AIC0040-F, AIC0041-F, AIC0042-F, AIC0043-F, AIC0044-F, AIC0045-F, AIC0046-F, AIC0074-F, AIC0075-F		

			
1			
código	560113	referencia	12009868
descripción	arandela int.ø 6.4mm ø ext. 12mm espesor 1.6mm inox UE 20 pzs DIN 125A para rosca M6		
Para modelos:	AIC0037-F, AIC0038-F, AIC0039-F, AIC0040-F, AIC0041-F, AIC0042-F, AIC0043-F, AIC0044-F, AIC0045-F, AIC0046-F, AIC0071-F, AIC0072-F, AIC0073-F, AIC0074-F, AIC0075-F, AIC0076-F, AIC0077-F, AIC0078-F, AIC0079-F, AIC0080-F		

			
1			
código	560132	referencia	12010284
descripción	tuerca hexagonal rosca M5 H 4mm EC 8 inox DIN/ISO DIN 934 / ISO 4032/8673 UE 20 pzs		
Para modelos:	AIC0037-F, AIC0038-F, AIC0039-F, AIC0040-F, AIC0041-F, AIC0042-F, AIC0043-F, AIC0044-F, AIC0045-F, AIC0046-F, AIC0071-F, AIC0072-F, AIC0073-F, AIC0074-F, AIC0075-F, AIC0076-F, AIC0077-F, AIC0078-F, AIC0079-F, AIC0080-F		

arandelas dentadas			
			
1			
código	560125	referencia	12009928
descripción	arandela dentada int.ø 4.2mm ø ext. 8mm inox DIN/ISO DIN 6798A UE 20 pzs para rosca M4		
Para modelos:	AIC0037-F, AIC0038-F, AIC0039-F, AIC0040-F, AIC0041-F, AIC0043-F, AIC0044-F, AIC0045-F, AIC0046-F, AIC0071-F, AIC0072-F, AIC0073-F, AIC0074-F, AIC0075-F, AIC0076-F, AIC0077-F, AIC0079-F, AIC0080-F		

tuercas anillos

			
1			
código	550662	referencia	256.377.00
descripción	tuerca anillo rosca M54x1,5 H 7mm		
Para modelos:	VS7040FRE17X, VS7040FRE88, VS7080FRE17X, VS9040FRE17, VS9040FRE21, VS9040FRE88, VS9080FRE17, VS9080FRE21		
accesorios para	550662		
		código	550449
		referencia	—
	llave especial para tuerca anillo		

anillos de junta

juntas de fibra

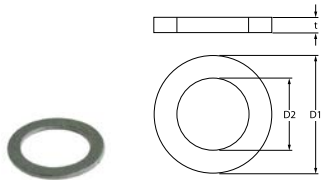
			
1			
código	510404	referencia	953.031.00
descripción	junta plana fibra ø ext. 44mm int.ø 34mm espesor 2mm UE 1 pzs		
Para modelos:	VS7080PEI50, VS7080PGI50, VS9080PEI150, VS9080PGI150		

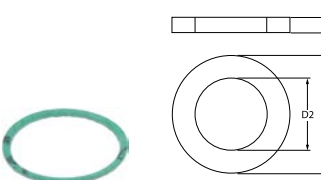
			
1			
código	529484	referencia	953.030.00
descripción	junta plana fibra ø ext. 58mm int.ø 50mm espesor 2mm UE 1 pzs		
Para modelos:	VS9080PEI150, VS9080PGI150		

juntas tóricas

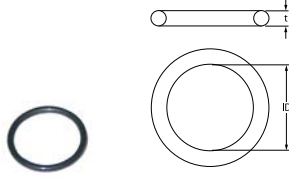
			
1			
código	510072	referencia	456016
descripción	junta tórica EPDM espesor 3.53mm int.ø 32.93mm UE 1 pzs		
Para modelos:	GLB0041, GLB0042		

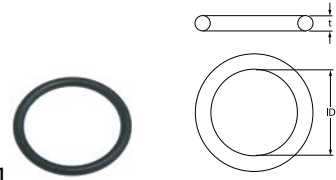
			
1			
código	510408	referencia	456002
descripción	junta tórica EPDM espesor 5.34mm int.ø 47mm UE 1 pzs		
Para modelos:	GLB0040, GLB0041, GLB0042, GLB0043C, GLB0043C-60Hz, GLB0044C		

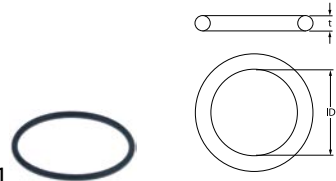
			
1			
código	510243	referencia	653.018.00
descripción	junta tórica Viton espesor 3.53mm int.ø 55.56mm UE 1 pzs		
Para modelos:	VS7040FRE17X, VS7040FRE88, VS7080FRE17X, VS9040FRE17, VS9040FRE21, VS9040FRE88, VS9080FRE17, VS9080FRE21		

juntas para bridas

			
1			
código	550069	referencia	12023679
descripción	junta L 210mm An 46mm D1 ø 12mm D2 ø 7mm grafito espesor 2mm para resistencia		
Para modelos:	AIC0041-F, AIC0045-F, AIC0073-F, AIC0075-F		

			
1			
código	550994	referencia	12023680
descripción	junta L 105mm An 60mm espesor 3mm para resistencia		
Para modelos:	AIC0037-F, AIC0039-F, AIC0041-F, AIC0043-F, AIC0045-F		

resortes de fijación

			
1			
código	550419	referencia	238.003.00
descripción	clip para bulbo para tubo ø 8.5mm para sonda ø 6mm UE 1 pzs		
Para modelos:	VS7040FRE10, VS7080FRE10, VS9040FRE15, VS9080FRE15		



tapas protectoras

 <p>1</p>			
código	510093	referencia	467002 69870
descripción	tapa de protección		
Para modelos:	GLB0040, GLB0041, GLB0042, GLB0043C, GLB0043C-60Hz, GLB0044C, GLB0045, GLB0047, GLB0048, GLB0049, GLB0050, GLB0051		

 <p>1</p>			
código	520876	referencia	463007
descripción	tapa de protección para resistencia ø 11.5mm H 32mm An 25mm plástico		
Para modelos:	GLB0041, GLB0042		

 <p>1</p>			
código	692776	referencia	983.009.00
descripción	estribo de retención para resistencia		
Para modelos:	VS9040FRE15, VS9080FRE15		

placas de cocción

cuadrada y rectangular

con borde integrado

 <p>1</p>			
código	490212	referencia	965.063.00
descripción	placa de cocción medidas 300x300mm 3500W 230V con borde integrado empalme 4 bornes de rosca protector presente cuadrado		
Para modelos:	VS7040PCEQT, VS7040PCET, VS7080PCEQT, VS7080PCET, VS9040PCEST, VS9080CFES, VS9080PCEST		

redondas

con borde integrado

para cocinas domésticas y industriales

 <p>1</p>			
código	490020	referencia	665.006.00
descripción	placa de cocción ø 220mm 2600W 230V empalme 4 bornes de rosca con borde de 8 mm		
Para modelos:	VS7040PCEQT, VS7040PCET, VS7080CFE, VS7080PCEQT, VS7080PCET		
accesorios para	490020		
	código	referencia	—
	550796		
	placa de sujeción para placa ø220mm		

reguladores de energía

EGO

a 1 circuito

 <p>1</p>			
código	380015	referencia	661.058.00
descripción	regulador de energía 230V 13A circuito simple sentido de rotación derecho eje ø 6x4,6mm eje L 23mm rosca de sujeción M4 liberación potencia 6-100% N° 50.57021.010		
Para modelos:	VS7080PEI50, VS7080PG50, VS7080PGI50, VS9080PEI50, VS9080PGI150		

a 2 circuitos

 <p>1</p>			
código	380027	referencia	661.102.00
descripción	regulador de energía EGO 230V 13A doble circuito sentido de rotación derecho eje ø 6x4,6mm eje L 23mm rosca de sujeción M4 liberación potencia 6-70% N° 50.55021.100		
Para modelos:	VS7080CFVE, VS7080PVET, VS9040PVET, VS9080CFVE, VS9080PVET		

termostatos

termostatos de superficie

termostatos de superficie de seguridad

 <p>1</p>			
código	390233	referencia	926189
descripción	termómetro de superficie de seguridad dist. del agujero 24mm temp. desconexión 110°C 1NC 1 polos 16A empalme F6,3 sujeción 2 orificios sin soporte		
Para modelos:	GLB0040, GLB0041, GLB0042, GLB0043C, GLB0043C-60Hz, GLB0044C, GLB0045, GLB0047, GLB0048, GLB0049, GLB0050, GLB0051		
accesorios para	390233		
	código	referencia	—
	504736		
	soporte para termostato de contacto		
	código	referencia	—
	550388		
	soporte para termostato de contacto distancia de sujeción 24.5mm fijación ø 3.8		



termostatos de control y seguridad

EGO

termostatos de regulación

serie 55.10/19_

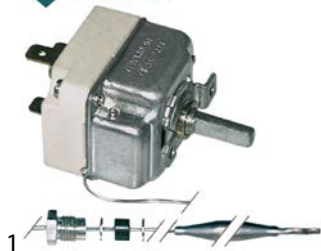

código	375001	referencia	661.004.00
descripción	termóstato T máx 112°C margen de trabajo 30-110°C 1 polos 1NO 16A sonda ø 6mm sonda L 130mm capilar 900mm aislamiento del capilar mm prensaestopas M9x1 eje L 23mm posición del eje arriba ángulo de rotación 270°		
Para modelos:	VS7040BMET, VS7040BMFEP, VS9040BMET, VS9040BMFEP		

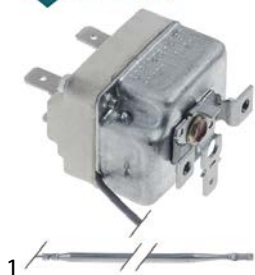

código	375548	referencia	961.039.00
descripción	termóstato T máx 142°C margen de trabajo ajuste fijo 142°C 1 polos 1CO 16A sonda ø 4mm sonda L 157mm capilar 870mm aislamiento del capilar 870mm prensaestopas eje ø 6x4,6mm eje Lmm posición del eje		
Para modelos:	VS7080PEI50, VS7080PGI50, VS9080PEI150, VS9080PGI150		



código	375945	referencia	661.121.00
descripción	termóstato T máx 470°C margen de trabajo 90-470°C 1 polos 1NO 16A sonda ø 3.9mm sonda L 163mm capilar 870mm aislamiento del capilar 600mm eje ø 4,5x6mm eje L 23mm posición del eje arriba ángulo de rotación 270°		
Para modelos:	VS7080TPET, VS7080TPFE, VS9080TPET, VS9080TPFE		

serie 55.13_



código	375492	referencia	961.034.00
descripción	termóstato T máx 190°C margen de trabajo 94-190°C 1 polos 1NO 16A sonda ø 6mm sonda L 94mm capilar 1090mm aislamiento del capilar 960mm prensaestopas M10x1 eje ø 6x4,6mm eje L 23mm posición del eje arriba ángulo de rotación 310° material de bulbo inox		
Para modelos:	VS7040FRE17X, VS7040FRE88, VS7040FRG17VL, VS7080FRE17X, VS7080FRG17VL, VS9040FRE17, VS9040FRE21, VS9040FRE88, VS9040FRG17VL, VS9040FRG21VL, VS9080FRE17, VS9080FRE21, VS9080FRG17VL, VS9080FRG21VL		

serie 55.34_



código	375143	referencia	661.005.00
descripción	termóstato T máx 110°C margen de trabajo 32-110°C 3 polos 3NO 16A sonda ø 6mm sonda L 138mm capilar 1480mm aislamiento del capilar 1100mm prensaestopas M9x1 eje ø 6x4,6mm eje L 23mm posición del eje arriba ángulo de rotación 270°		
Para modelos:	VS7080BMET, VS7080BMFEP, VS9080BMET, VS9080BMFEP		



código	375097	referencia	661.041.00
descripción	termóstato T máx 195°C margen de trabajo 95-195°C 3 polos 3NO 16A sonda ø 6mm sonda L 117mm capilar 1780mm aislamiento del capilar 1400mm prensaestopas M9x1 eje ø 6x4,6mm eje L 23mm posición del eje arriba ángulo de rotación 270°		
Para modelos:	VS7040FRE10, VS7080FRE10, VS9040FRE15, VS9080FRE15		



código	375559	referencia	661.123.00
descripción	termóstato T máx 230°C margen de trabajo 95-230°C 3 polos 3NO 16A sonda ø 4mm sonda L 128mm capilar 1250mm aislamiento del capilar 1000mm prensaestopas eje ø 6x4,6mm eje L 23mm posición del eje arriba ángulo de rotación 270°		
Para modelos:	VS7040GRACQE, VS7080GRACQE, VS9040GRACQE, VS9080GRACQE		

serie 55.32_



código	375316	referencia	661.051.00
descripción	termostato de seguridad temp. desconexión 140°C 3 polos 20A sonda ø 6mm sonda L 173mm capilar 830mm aislamiento del capilar 800mm prensaestopas bulbo inox		
Para modelos:	VS7040BMET, VS7040BMFEP, VS7040CPES, VS7080BMET, VS7080BMFEP, VS7080CPES, VS9040BMET, VS9040BMFEP, VS9040CPES, VS9080BMET, VS9080BMFEP, VS9080CPES		



código	375944	referencia	661.116.00
descripción	termóstato T máx 350°C margen de trabajo 100-350°C 3 polos 3NOA sonda ø 3mm sonda L 147mm capilar 900mm aislamiento del capilar 900mm prensaestopas eje ø 6x4,6mm eje L 26mm posición del eje arriba ángulo de rotación 270° material de bulbo inox		
Para modelos:	V080FTREVCRT, V7040FTREVCRT, V9040FTREVCRT, V9080FTREVCRT, V9080FTTRREVCRT, VS7040FTET, VS7040FTEVCRT, VS7040FTEVT, VS7040FTRET, VS7040FTREVT, VS7080FTET, VS7080FTEVCRT, VS7080FTEVT, VS7080FTRET, VS7080FTREVT, VS7080FTTRREVC, VS7080FTTRREVCRT, VS9040FTEVCRT, VS9040FTET, VS9040FTEVCRT, VS9040FTEVT, VS9040FTREVCRT, VS9040FTRET, VS9040FTREVT, VS9080FTEVCRT, VS9080FTET, VS9080FTEVCRT, VS9080FTEVT, VS9080FTREVCRT, VS9080FTRET, VS9080FTREVT, VS9080FTTRRET, VS9080FTTRREVC, VS9080FTTRREVCRT		



código	375375	referencia	961.033.00
descripción	termostato de seguridad temp. desconexión 230°C 3 polos 20A sonda ø 6mm sonda L 94mm capilar 900mm aislamiento del capilar 670mm prensaestopas M10x1 bulbo inox		
Para modelos:	VS7040FRE17X, VS7040FRE88, VS7080FRE17X, VS9040FRE17, VS9040FRE21, VS9040FRE88, VS9080FRE17, VS9080FRE21		

termostatos de seguridad

serie 55.13_

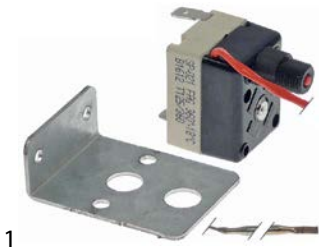

código	375441	referencia	12024591
descripción	termostato de seguridad temp. desconexión 360°C 1 polos 1NC 16A sonda ø 3mm sonda L 110mm capilar 870mm aislamiento del capilar 700mm prensaestopas bulbo unión roscada M8x1		
Para modelos:	AIC0037-F, AIC0038-F, AIC0039-F, AIC0040-F, AIC0041-F, AIC0042-F, AIC0043-F, AIC0044-F, AIC0045-F, AIC0046-F, AIC0071-F, AIC0072-F, AIC0073-F, AIC0074-F, AIC0075-F, AIC0076-F, AIC0077-F, AIC0078-F, AIC0079-F, AIC0080-F		



código	375445	referencia	961.044.00
descripción	termostato de seguridad temp. desconexión 230°C 3 polos 2x20/1x0,5A sonda ø 4mm sonda L 120mm capilar 900mm aislamiento del capilar 700mm prensaestopas bulbo		
Para modelos:	VS7040FRGS13, VS7080FRGS13, VS9040FRGS13, VS9040FRGS20, VS9080FRGS13, VS9080FRGS20		

E-G-O

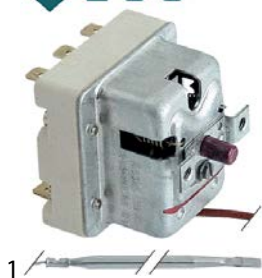

código	375312	referencia	661.048.00
---------------	--------	-------------------	------------

descripción	termostato de seguridad temp. desconexión 245°C 3 polos 3NC 20A sonda ø 4mm sonda L 120mm capilar 1800mm aislamiento del capilar 1800mm prensaestopas bulbo inox
--------------------	--

Para modelos:	VS7040FRE10, VS7080FRE10, VS9040FRE15, VS9080FRE15
----------------------	--

accesorios para	375312
------------------------	--------



código	550981	referencia	—
---------------	--------	-------------------	---

clip para bulbo para tubo ø 8.5mm para sonda ø 6mm para distancia resistencia 0.4mm UE 1 pzs

E-G-O



código	375187	referencia	661.115.00
---------------	--------	-------------------	------------

descripción	termostato de seguridad temp. desconexión 360°C 3 polos 3NC 2x20/1x0,5A sonda ø 6mm sonda L 79mm capilar 890mm aislamiento del capilar mm prensaestopas bulbo inox
--------------------	--

Para modelos:	V080FTREVCRT, V7040FTREVCRT, V9040FTREVCRT, V9080FTREVCRT, V9080FTRREVCRT, VS70120CFGE, VS7040FTET, VS7040FTEVCRT, VS7040FTEVT, VS7040FTRET, VS7040FTREVT, VS7080BREI, VS7080BREIM, VS7080BRGI, VS7080BRGIM, VS7080CFE, VS7080CFEQ, VS7080CFGE, VS7080CFVE, VS7080FTET, VS7080FTEVCRT, VS7080FTEVT, VS7080FTRET, VS7080FTREVT, VS7080FTRRET, VS7080FTRREVC, VS7080FTRREVT, VS7080PG50, VS7080TPFE, VS90120CFGE, VS90160CFGE, VS9040FTECART, VS9040FTET, VS9040FTEVCRT, VS9040FTEVT, VS9040FTRREVCRT, VS9040FTRET, VS9040FTREVT, VS9080BREI, VS9080BREIM, VS9080BRGI, VS9080BRGIM, VS9080CFES, VS9080CFGE, VS9080CFVE, VS9080FTECART, VS9080FTET, VS9080FTEVCRT, VS9080FTEVT, VS9080FTREVCRT... (Otros modelos se puede ver en la tienda web)
----------------------	--

serie 56_

E-G-O



código	375447	referencia	12024884
---------------	--------	-------------------	----------

descripción	termostato de seguridad temp. desconexión 150°C 1 polos 1CO 16A sonda ø 6mm sonda L 77mm capilar 1460mm aislamiento del capilar 1100mm prensaestopas M9x1 temperatura de conexión 139°C bulbo
--------------------	---

Para modelos:	AIC0037-F, AIC0038-F, AIC0039-F, AIC0040-F, AIC0041-F, AIC0042-F, AIC0043-F, AIC0044-F, AIC0045-F, AIC0046-F
----------------------	--

E-G-O



código	375783	referencia	961.035.00
---------------	--------	-------------------	------------

descripción	termostato de seguridad temp. desconexión 240°C 1 polos 0.5A sonda ø 6mm sonda L 77mm capilar 860mm aislamiento del capilar 750mm prensaestopas M10x1 bulbo inox
--------------------	--

Para modelos:	VS7040FRG17VL, VS7080FRG17VL, VS9040FRG17VL, VS9040FRG21VL, VS9080FRG17VL, VS9080FRG21VL
----------------------	--

termostatos de regulación con interruptor auxiliar

serie 55.13_

E-G-O

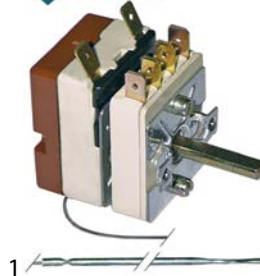

código	375073	referencia	961.045.00
---------------	--------	-------------------	------------

descripción	termostato T máx 320°C margen de trabajo 50-320°C 1 polos aislamiento del capilar mm prensaestopas
--------------------	--

Para modelos:	VS7080BREI, VS7080BREIM, VS7080BRGI, VS7080BRGIM, VS9080BREI, VS9080BREIM, VS9080BRGI, VS9080BRGIM
----------------------	--

IMIT / TEMPOMATIC / ARATHERMO

termostatos de seguridad





código	390770	referencia	927057
---------------	--------	-------------------	--------

descripción	termostato de seguridad temp. desconexión 90-110°C 1 polos 1CO 16/0,5A sonda ø 6.5mm sonda L 90mm capilar 2000mm aislamiento del capilar 1950mm prensaestopas bulbo
--------------------	---

Para modelos:	GLB0047, GLB0048, GLB0049
----------------------	---------------------------



TECASA			
termostatos de seguridad			
			
código	390452	referencia	12023830
descripción	termostato de seguridad temp. desconexión 125°C 1 polos 16A sonda ø 6mm sonda L 73mm capilar 870mm aislamiento del capilar 690mm prensaestopas M9x1 bulbo inox		
Para modelos:	GLB0067-F, GLB0069-F, GLB0071-F, GLB0080, GLB0081, GLB0082		

accesorios			
clips para bulbo			
resortes de fijación			
para termostato			
			
código	550419	referencia	238.003.00
descripción	clip para bulbo para tubo ø 8.5mm para sonda ø 6mm UE 1 pzs		
Para modelos:	VS7040FRE10, VS7080FRE10, VS9040FRE15, VS9080FRE15		

casquillos de inmersión			
			
código	513031	referencia	929038
descripción	casquillo de inmersión L 125mm inox simple		
Para modelos:	GLB0045, GLB0047, GLB0048, GLB0049, GLB0050, GLB0051		

interruptores y pulsadores			
interruptores/pulsadores basculantes			
30x22mm			
			
código	301003	referencia	B00DU102
descripción	interruptor basculante medida de montaje 30x22mm verde 2NO 250V 16A iluminado 0-1 empalme conector Faston 6,3mm temperatura ambiente máx. 125/55°C protección IP65		
Para modelos:	BMA0008-F, BMA0010-F, BMA0021-F, BMA0022-F, BMA0024-F, BMA0025-F, BMA0027-F, BMA0028-F, BMA0029-F, BMA0036-F, BMB0030-F, BMB0036-F, BMB0037-F, BMC0014-F, BMC0016-F, BNA0030-F, BNA0031-F, BNA0036-F, BNA0037-F, BNA0044-F, BNA0045-F, BNA0052-F, BNA0053-F, BNA0054-F, BNA0055-F, BNA0056-F, BNA0057-F, BNA0064-F, BNA0065-F, BNA0066-F, BNB0010-F, BNB0011-F, BNB0012-F, BNB0013-F, BNB0014-F, BNB0015-F, BNZ0001-F, BNZ0002-F, BNZ0003-F, BNZ0004-F, BNZ0005-F, BNZ0006-F, BNZ0007-F, BNZ0008-F, CCZ0036-F, CCZ0037-F, PB9RI-F, VTGB2A-F, VTGB2-F, VTGB3A-F...(Otros modelos se puede ver en la tienda web)		
accesorios para	301003		
		código	301036
		referencia	—
	cubierta protectora dimensión interior 30x22mm para interruptor basculante medida de montaje mm		

interruptores pulsantes y pulsadores			
ø22mm			
			
código	348233	referencia	12023927
descripción	pulsador montaje ø 22mm negro 1NO/1NC 250V 3A empalme F2,8x0,5		
Para modelos:	AIC0037-F, AIC0038-F, AIC0039-F, AIC0040-F, AIC0041-F, AIC0042-F, AIC0043-F, AIC0044-F, AIC0045-F, AIC0046-F		
ø25mm			
			
código	348219	referencia	961.048.00
descripción	pulsador montaje ø 25mm negro 1NO 250V 16A empalme conector Faston 6,3mm temperatura ambiente máx. 120°C		
Para modelos:	VS7080BREI, VS7080BREIM, VS7080BRGI, VS7080BRGIM, VS9080BREI, VS9080BREIM, VS9080BRGI, VS9080BRGIM		



			
1			
código	345039	referencia	961.049.00
descripción	cubierta protectora redondo ø ext. 33mm dimensiones exteriores 23mm dimensión interior 21mm H 12mm claro montaje ø 25mm		
Para modelos:	VS7080BREI, VS7080BREIM, VS7080BRGI, VS7080BRGIM, VS9080BREI, VS9080BREIM, VS9080BRGI, VS9080BRGIM		
accesorios para	345039		
	código	345001	referencia
			—
	pulsador montaje ø 25mm amarillo 1NO/lámpara 250V 16A cubierta empalme conector Faston 6,3mm temperatura ambiente máx. 85°C protección IP65		

accesorios

juntas

			
1			
código	551456	referencia	953.020.00
descripción	junta para interruptor ø ext. 14mm int. ø 2.5mm espesor 3.5mm blanco		
Para modelos:	V080FTREVCRT, V7040FTREVCRT, V9040FTREVCRT, V9080FTREVCRT, V9080FTRRECRT, VS70120CFGE, VS7040BMET, VS7040BMFEP, VS7040CPES, VS7040FRE10, VS7040FRE17X, VS7040FRE88, VS7040FRG17VL, VS7040FTET, VS7040FTEVCRT, VS7040FTEVT, VS7040FTRET, VS7040FTREVT, VS7040GRACQE, VS7040PCEQT, VS7040PCET, VS7040SPET, VS7080BMET, VS7080BMFEP, VS7080BREI, VS7080BREIM, VS7080BRGI, VS7080BRGIM, VS7080CFE, VS7080CFEQ, VS7080CFGE, VS7080CFVE, VS7080CPES, VS7080FRE10, VS7080FRE17X, VS7080FRG17VL, VS7080FTET, VS7080FTEVCRT, VS7080FTEVT, VS7080FTRET, VS7080FTREVT, VS7080FTRRET, VS7080FTRREC, VS7080FTRREV, VS7080GRACQE, VS7080PCEQT, VS7080PCET, VS7080PEI50, VS7080PG50, VS7080PGI50... (Otros modelos se puede ver en la tienda web)		

microinterruptores

accionado por palanca

			
1			
código	345773	referencia	761.004.00
descripción	microinterruptor con manilla 250V 16A 1CO empalme conector Faston 6,3mm L 60mm temperatura ambiente máx. 125°C distancia de sujeción 22mm fuerza de accionamiento: 65g longitud de palanca 51mm		
Para modelos:	VS7040FRE10, VS7040FRE17X, VS7040FRE88, VS7080BREI, VS7080BREIM, VS7080BRGI, VS7080BRGIM, VS7080FRE10, VS7080FRE17X, VS9040FRE15, VS9040FRE17, VS9040FRE21, VS9040FRE88, VS9080BREI, VS9080BREIM, VS9080BRGI, VS9080BRGIM, VS9080FRE15, VS9080FRE17, VS9080FRE21		

			
1			
código	345125	referencia	927246
descripción	microinterruptor con manilla 250V 16A 1CO empalme conector Faston 6,3mm temperatura ambiente máx. 85°C distancia de sujeción 25mm tipo C99ZP3 fuerza de accionamiento: 25g longitud de palanca 63.5mm		
Para modelos:	GLB0045, GLB0047, GLB0048, GLB0049, GLB0050, GLB0051		

accionados por palanca de rodillo

microinterruptores

			
1			
código	345250	referencia	12025193
descripción	microinterruptor con palanca de rodillo 250V 16A 1CO empalme conector Faston 6,3mm L 27mm L1 36mm temperatura ambiente máx. 125°C distancia de sujeción 22mm tipo RL6-1-FGE-P12-5-L fuerza de accionamiento: 90g		
Para modelos:	AIC0037-F, AIC0038-F, AIC0039-F, AIC0040-F, AIC0041-F, AIC0042-F, AIC0043-F, AIC0044-F, AIC0045-F, AIC0046-F, AIC0071-F, AIC0072-F, AIC0073-F, AIC0074-F, AIC0075-F, AIC0076-F, AIC0077-F, AIC0078-F, AIC0079-F, AIC0080-F		

con tecla

interruptores de enganche rápido

			
1			
código	348008	referencia	B00DU103
descripción	microinterruptor con tecla 250V 2.5A 1NO/1NC empalme conector Faston 2,8mm/6,3mm L 27mm L1 22mm temperatura ambiente máx. 104°C fuerza de accionamiento: 180g		
Para modelos:	BMA0008-F, BMA0010-F, BMA0021-F, BMA0022-F, BMA0024-F, BMA0025-F, BMA0026-F, BMA0027-F, BMA0028-F, BMA0029-F, BMA0032-F, BMA0035-F, BMA0036-F, BMB0028-F, BMB0029-F, BMB0030-F, BMB0033-F, BMB0034-F, BMB0035-F, BMB0036-F, BMB0037-F, BMC0012-F, BMC0014-F, BMC0015-F, BMC0016-F, PB9RI-F		

accionados por rodillo

rollo 0°

			
1			
código	348145	referencia	91310430
descripción	microinterruptor 250V 16A 1CO empalme atornillado rosca L 15mm rosca M12x1 distancia de sujeción 25.4mm fuerza de accionamiento: 500g tipo MK V11D15		
Para modelos:	CBC0001, CBC0002, CBC0003, CBC0004		

accesorios



código	691077	referencia	12009985
descripción	aislamiento L 45mm para microinterruptor An 30mm espesor 1mm		
Para modelos:	AIC0037-F, AIC0038-F, AIC0039-F, AIC0040-F, AIC0041-F, AIC0042-F, AIC0043-F, AIC0044-F, AIC0045-F, AIC0046-F, AIC0071-F, AIC0072-F, AIC0073-F, AIC0074-F, AIC0075-F, AIC0076-F, AIC0077-F, AIC0078-F, AIC0079-F, AIC0080-F		

conmutadores de levas

7 posiciones



código	300025	referencia	661.002.00
descripción	conmutador de levas 7 posiciones de conmutación 1NO/2CO secuencia de conmutación 0-1-2-3-4-5-6 16A eje ø 6x4,6mm eje L 23mm empalme atornillado 7 posiciones cerámica		
Para modelos:	VS7040PCEQT, VS7040PCET, VS7080CFE, VS7080CFEQ, VS7080PCEQT, VS7080PCET, VS9080CFES		

accesorios para

	código	112172	referencia	—
				pomo universal ø 70mm negro sin adaptador/símbolo
	código	112213	referencia	—
				símbolo para pomo plata interruptor 7 posiciones T máx°C°C ø ext. 63mm int.ø 45.5mm
	código	112311	referencia	—
				adaptador de pomo eje ø 6x4,6mm L 0mm con muelle



código	300106	referencia	961.000.00
descripción	conmutador de levas 7 posiciones de conmutación 1NO/2CO secuencia de conmutación 0-1-2-3-4-5-6 32A eje ø 6x4,6mm eje L 23mm empalme atornillado 7 posiciones parte plana arriba		
Para modelos:	VS9040PCEST, VS9080PCEST		

4 posiciones de conmutación

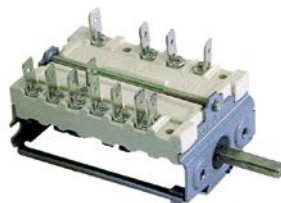

código	300010	referencia	661.117.00
descripción	conmutador de levas 4 posiciones de control 2NO/2CO secuencia de conmutación 0-1-2-3 16A eje ø 6x4,6mm eje L 23mm empalme conector Faston 6,3mm cerámica		
Para modelos:	VS7080PEI50, VS7080PG50, VS7080PGI50, VS9080PEI150, VS9080PGI150		



código	300081	referencia	661.113.00
descripción	conmutador de levas 4 posiciones de control 3NO/2CO secuencia de conmutación 0-1-2-3 16A eje ø 6x4,6mm eje L 23mm empalme atornillado		
Para modelos:	VS70120CFGE, VS7080CFE, VS7080CFEQ, VS7080CFGE, VS7080CFVE, VS7080TPFE, VS90120CFGE, VS90160CFGE, VS9080CFES, VS9080CFGE, VS9080CFVE, VS9080TPFE		



código	300210	referencia	661.037.00
descripción	conmutador de levas 4 posiciones de control 4NO secuencia de conmutación 0-1-2-3 16A eje ø 6x4,6mm eje L 23mm empalme atornillado cerámica		
Para modelos:	VS7040CPES, VS7080CPES, VS9040CPES, VS9080CPES		

accesorios para	300210	código	551456	referencia	953.020.00
					junta para interruptor ø ext. 14mm int.ø 2.5mm espesor 3.5mm blanco

con potenciómetro



código	300252	referencia	961.042.00
descripción	potenciómetro 2 posiciones de conmutación 2NO secuencia de conmutación 0-1 16A eje ø 6x4,6mm eje L 23mm empalme conector codificado longitud del cable 1420mm 10kOhm 12V con cable y lámpara de señalización		
Para modelos:	VS9040INDT, VS9040INDWT, VS9080INDT		



interruptor auxiliar

E-G-O



1

código	300080	referencia	661.000.00
descripción	conmutador de levas 2 posiciones de conmutación 4NO 16A secuencia de conmutación 0-1 eje \varnothing 6x4,6mm eje L 23mm empalme atornillado interruptor cerámica temperatura ambiente máx. 150°C		
Para modelos:	V080FTREVCRT, V7040FTREVCRT, V9040FTREVCRT, V9080FTREVCRT, V9080FTTRECRT, VS7040BMET, VS7040BMFEP, VS7040FRE10, VS7040FTET, VS7040FTEVCRT, VS7040FTEVT, VS7040FTRET, VS7040FTREVT, VS7040GRACQE, VS7040SPET, VS7080BMET, VS7080BMFEP, VS7080FRE10, VS7080FTET, VS7080FTEVCRT, VS7080FTEVT, VS7080FTRET, VS7080FTREVT, VS7080FTRRET, VS7080FTRREVC, VS7080FTRREVT, VS7080GRACQE, VS9040BMET, VS9040BMFEP, VS9040FRE15, VS9040FTECRT, VS9040FTET, VS9040FTEVCRT, VS9040FTEVT, VS9040FTRECRT, VS9040FTRET, VS9040FTEVT, VS9040GRACQE, VS9040SPET, VS9080BMET, VS9080BMFEP, VS9080FRE15, VS9080FTECRT, VS9080FTET, VS9080FTEVCRT, VS9080FTEVT, VS9080FTRECRT, VS9080FTRET, VS9080FTREVT, VS9080FTRRET...(Otros modelos se puede ver en la tienda web)		
accesorios para	300080		
	código	551456	referencia 953.020.00
	junta para interruptor \varnothing ext. 14mm int. \varnothing 2.5mm espesor 3.5mm blanco		

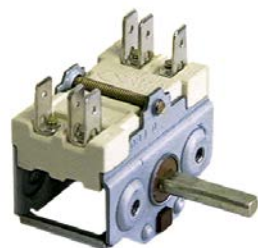

1

código	300001	referencia	661.093.00
descripción	conmutador de levas interruptor 16A secuencia de conmutación 0-1 eje \varnothing 6x4,6mm empalme conector Faston 6,3mm 2 polos		
Para modelos:	VS7040FRE17X, VS7040FRE88, VS7040FRG17VL, VS7080FRE17X, VS7080FRG17VL, VS7080TPET, VS7080TPFE, VS9040FRE17, VS9040FRE21, VS9040FRE88, VS9040FRG17VL, VS9040FRG21VL, VS9080FRE17, VS9080FRE21, VS9080FRG17VL, VS9080FRG21VL, VS9080TPET, VS9080TPFE		
accesorios para	300001		
	código	551456	referencia 953.020.00
	junta para interruptor \varnothing ext. 14mm int. \varnothing 2.5mm espesor 3.5mm blanco		

interruptores magnéticos

36x13mm



1

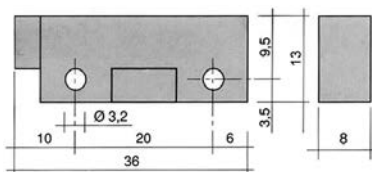

código	345118 ¹	referencia	211002 211002AG 80871
descripción	interruptor magnético L 36mm An 13mm 1NO 250V 1A P máx. 50W empalme cable longitud del cable 980mm		
Para modelos:	GLB0040, GLB0041, GLB0043C, GLB0043C-60Hz, GLB0044C, GLB0045, GLB0047, GLB0048, GLB0049, GLB0050, GLB0051		
accesorios para	345118		
	código	345399	referencia 927088 CWM7
	imán \varnothing 3.3mm L 40mm H 8mm An 13mm dist. del agujero 30mm M3		

¹con conexión codificado

65x20mm



1

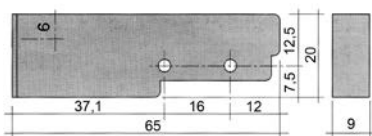

código	345116	referencia	12024560 927017
descripción	interruptor magnético L 65mm An 20mm 1NO 250V 0.4A P máx. 100W empalme cable longitud del cable 3000mm		
Para modelos:	AIC0037-F, AIC0038-F, AIC0039-F, AIC0040-F, AIC0041-F, AIC0042-F, AIC0043-F, AIC0044-F, AIC0045-F, AIC0046-F, AIC0071-F, AIC0072-F, AIC0073-F, AIC0074-F, AIC0075-F, AIC0076-F, AIC0077-F, AIC0078-F, AIC0079-F, AIC0080-F, GLB0041, GLB0042, GLB0045, GLB0047, GLB0048		
accesorios para	345116		
	código	345399	referencia 927088 CWM7
	imán \varnothing 3.3mm L 40mm H 8mm An 13mm dist. del agujero 30mm M3		



∅ 6mm



1

código	345202	referencia	12024477
descripción	interruptor magnético 250V 0.04A P máx. 10W sonda L 29mm 1NO empalme conector longitud del cable 1400mm		
Para modelos:	BKZ0008-F, BKZ0022-F, BKZ0023-F, BKZ0027-F, BKZ0028-F, BKZ0040, BKZ0041, GLB0067-F, GLB0069-F, GLB0071-F, GLB0080, GLB0081, GLB0082		

accesorios

imanes



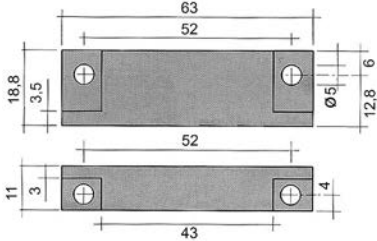

1

código	345399	referencia	927088 CWM7
descripción	imán ∅ 3.3mm L 40mm H 8mm An 13mm dist. del agujero 30mm M3		
Para modelos:	GLB0045, GLB0047, GLB0048, GLB0049, GLB0050, GLB0051		

1

código	345336	referencia	926014
descripción	imán ∅ 4.8mm L 63mm H 11mm An 18.8mm dist. del agujero 51mm M4		
Para modelos:	GLB0045, GLB0047, GLB0048, GLB0049, GLB0050, GLB0051		



1

código	505004	referencia	12024303
descripción	imán ∅mm L 17mm H 12mm An 14mm		
Para modelos:	AIC0037-F, AIC0038-F, AIC0039-F, AIC0040-F, AIC0041-F, AIC0042-F, AIC0071-F, AIC0072-F, AIC0073-F, AIC0076-F, AIC0077-F, AIC0078-F		

aparatos de mando y aviso

LOVATO



1

código	301321	referencia	961.051.00
descripción	bloque de contacto LOVATO LPX C10 1NO máx. 690V 10A gris claro		
Para modelos:	VS7080BREIM, VS7080BRGIM, VS9080BREIM, VS9080BRGIM		

serie plástico

selectores giratorios



1

código	301320	referencia	961.050.00
descripción	selector giratorio medida de montaje ∅22mm negro/argénteo secuencia de conmutación 1-0-2 con enclavamiento		
Para modelos:	VS7080BREIM, VS7080BRGIM, VS9080BREIM, VS9080BRGIM		

codificadores y potenciómetros



1

código	300252	referencia	961.042.00
descripción	potenciómetro 2 posiciones de conmutación 2NO secuencia de conmutación 0-1 16A eje ∅ 6x4,6mm eje L 23mm empalme conector codificado longitud del cable 1420mm 10kOhm 12V con cable y lámpara de señalización		
Para modelos:	VS9040INDT, VS9040INDWT, VS9080INDT		

lámparas

lámparas de señalización

lámparas de señalización 2 piezas (lente y elemento)

elementos de señalización para tipo de casquillo SA / SC / SD / SF / SR



1

código	360736	referencia	663.082.00
descripción	lámpara de señalización 250V rojo empalme de dos hilos longitud del cable 800mm material de cable silicona		
Para modelos:	VS7080CFVE, VS7080PVET, VS9040PVET, VS9080CFVE, VS9080PVET		



lámparas de señalización completas

ø 8mm



1

código	360742	referencia	963.016.00
descripción	lámpara de señalización ø 8mm verde 28V empalme conector Faston 2,8mm		
Para modelos:	VS9040INDT, VS9040INDWT, VS9080INDT		

ø 12mm

con casquillo roscado



1

código	360763	referencia	963.014.00
descripción	lámpara de señalización ø 12mm rojo 230V empalme conector Faston 6,3mm con junta tórica		
Para modelos:	VS7080PEI50, VS7080PGI50, VS7080TPET, VS7080TPFE, VS9080PEI150, VS9080PGI150, VS9080TPET, VS9080TPFE		

ø 13mm

con casquillo roscado



1

código	359146	referencia	963.013.00
descripción	lámpara de señalización ø 13mm 230V amarillo		
Para modelos:	V080FTREVCRT, V7040FTREVCRT, V9040FTREVCRT, V9080FTREVCRT, V9080FTRRECR, VS70120CFGE, VS7040BMET, VS7040BMFEP, VS7040CPES, VS7040FRE10, VS7040FRE17X, VS7040FRE88, VS7040FRG17VL, VS7040FTET, VS7040FTEVCRT, VS7040FTEVT, VS7040FTRET, VS7040FTREVT, VS7040GRACQE, VS7040PCEQT, VS7040PCET, VS7040SPET, VS7080BMET, VS7080BMFEP, VS7080BREI, VS7080BREIM, VS7080BRGI, VS7080BRGIM, VS7080CFE, VS7080CFEQ, VS7080CFGE, VS7080CFVE, VS7080CPES, VS7080FRE10, VS7080FRE17X, VS7080FRG17VL, VS7080FTET, VS7080FTEVCRT, VS7080FTEVT, VS7080FTRET, VS7080FTREVT, VS7080FTRRET, VS7080FTRREVC, VS7080FTRREVT, VS7080GRACQE, VS7080PCEQT, VS7080PCET, VS7080PEI50, VS7080PG50, VS7080PGI50...(Otros modelos se puede ver en la tienda web)		

accesorios para	359146			
	código	510302	referencia	—
	junta tórica EPDM int.ø 12.42mm espesor 1.78mm UE 1 pzs			
	código	511505	referencia	—
	junta tórica EPDM espesor 1.78mm int.ø 12.42mm UE 10 pzs			

30x22mm



1

código	301303	referencia	B00DU101
descripción	elemento de señalización medida de montaje 30x22mm rojo lámpara 250V 16A empalme conector Faston 6,3mm temperatura ambiente máx. 125°C protección IP40		
Para modelos:	BMA0008-F, BMA0010-F, BMA0021-F, BMA0022-F, BMA0024-F, BMA0025-F, BMA0027-F, BMA0028-F, BMA0029-F, BMA0036-F, BMB0030-F, BMB0036-F, BMB0037-F, BMC0014-F, BMC0016-F, BNA0036-F, BNA0037-F, BNA0045-F, BNA0052-F, BNA0053-F, BNA0054-F, BNA0055-F, BNA0056-F, BNA0057-F, BNA0064-F, BNA0065-F, BNA0066-F, BNB0010-F, BNB0011-F, BNB0012-F, BNB0013-F, BNB0014-F, BNB0015-F, BNZ0004-F, BNZ0006-F, BNZ0007-F, BNZ0008-F, PB9RI-F, VTGB2-F, VTGB3-F, VTGB4A-F, VTGB4-F		

LEDs

elementos de señalización

diámetro de montaje 8mm



1

código	360744	referencia	963.015.00
descripción	lámpara de señalización LED montaje ø 8mm rojo 5-28VDC empalme F2,8x0,8 rosca de sujeción M8		
Para modelos:	VS9040INDT, VS9040INDWT, VS9080INDT		

barras de LED



1

código	357216	referencia	B00LA370
descripción	barra de LED L 1200mm An 20mm H 20mm aluminio longitud del cable 1000mm		
Para modelos:	BNA0065-F		



1

código	357217	referencia	B00LA470
descripción	barra de LED L 1600mm An 20mm H 20mm aluminio longitud del cable 750mm		
Para modelos:	BNA0066-F		

			
1			
código	357215	referencia	B00LA700
descripción	barra de LED L 500mm An 19mm H 7mm aluminio longitud del cable 900mm		
Para modelos:	BMB0035-F, BMB0037-F		

			
1			
código	357214	referencia	B00LA270
descripción	barra de LED L 690mm An 20mm H 20mm aluminio longitud del cable 850mm		
Para modelos:	BNA0064-F		

lámpade

lámparas halógenas

para portalámpara G4 / G6,35 / G9

			
1	500°C		
código	359596	referencia	12025123
descripción	lámpara halógena casquillo G4 12V 10W resis.a la temp. 500°C		
Para modelos:	AIC0037-F, AIC0038-F, AIC0039-F, AIC0040-F, AIC0041-F, AIC0042-F, AIC0043-F, AIC0044-F, AIC0045-F, AIC0046-F, AIC0071-F, AIC0072-F, AIC0073-F, AIC0074-F, AIC0075-F, AIC0076-F, AIC0077-F, AIC0078-F, AIC0079-F, AIC0080-F		

lámparas para hornos

lámparas

lámparas halógenas

para portalámpara G4 / G6,35 / G9

			
1	500°C		
código	359596	referencia	12025123
descripción	lámpara halógena casquillo G4 12V 10W resis.a la temp. 500°C		
Para modelos:	AIC0037-F, AIC0038-F, AIC0039-F, AIC0040-F, AIC0041-F, AIC0042-F, AIC0043-F, AIC0044-F, AIC0045-F, AIC0046-F, AIC0071-F, AIC0072-F, AIC0073-F, AIC0074-F, AIC0075-F, AIC0076-F, AIC0077-F, AIC0078-F, AIC0079-F, AIC0080-F		

contactores

GENERAL ELECTRIC (AEG)

contactores de potencia

			
1			
código	380237	referencia	12024011
descripción	contactor de potencia AC1 16A 230VAC (AC3/400V) 6A/3kW contactos principales 3NO contactos auxiliares 1NC empalme conector Faston 6,3mm tipo AEG LS0701F		
Para modelos:	AIC0037-F, AIC0038-F, AIC0039-F, AIC0040-F, AIC0041-F, AIC0042-F, AIC0043-F, AIC0044-F, AIC0045-F, AIC0046-F, AIC0071-F, AIC0072-F, AIC0073-F, AIC0074-F, AIC0075-F, AIC0076-F, AIC0077-F, AIC0078-F, AIC0079-F, AIC0080-F, GLB0067-F, GLB0069-F, GLB0071-F, GLB0080, GLB0081, GLB0082		

			
1			
código	380239	referencia	926040
descripción	contactor de potencia AC1 20A 230VAC (AC3/400V) 8,4A/4kW contactos principales 3NO contactos auxiliares 1NC empalme empalme atornillado tipo LS05 01A tipo AEG LS05 01A tipo GE MC1A 301A		
Para modelos:	GLB0047, GLB0048, GLB0050, GLB0051		

			
1			
código	381191	referencia	926282 DTC112NO
descripción	contactor de potencia AC1 25A 400VAC (AC3/400V) 12A/5,5kW contactos principales 3NO contactos auxiliares 1NO empalme empalme atornillado tipo AEG tipo GE CL01A310T6		
Para modelos:	GLB0041, GLB0042, GLB0044C		



ISKRA (FANAL)

contactores de potencia



1

código	380547	referencia	461.021.00
descripción	contactor de potencia AC1 20A 230VAC (AC3/400V) 5A/2,2kW contactos principales 3NO contactos auxiliares 1NC empalme empalme atornillado tipo FANAL DSL3 01 tipo ISKRA K03M 01		
Para modelos:	VS7040FRE10, VS7040FRE17X, VS7040FRE88, VS7080BREI, VS-7080BREIM, VS7080FRE10, VS7080FRE17X, VS7080PEI50, VS-9040FRE15, VS9040FRE17, VS9040FRE88, VS9080FRE15, VS9080FRE17		

LOVATO

contactores de potencia



1

código	380714	referencia	91310136
descripción	contactor de potencia AC1 25A 230VAC (AC3/400V) 9A/4,2kW contactos principales 3NO contactos auxiliares 1NO empalme empalme atornillado tipo BF0910A230		
Para modelos:	CBC0001, CBC0002, CBC0003, CBC0004		



1

código	380716	referencia	961.002.00
descripción	contactor de potencia AC1 28A 230VAC (AC3/400V) 12A/5,7kW contactos principales 3NO contactos auxiliares 1NO empalme empalme atornillado tipo BF1210A230		
Para modelos:	VS7040FRE17X, VS7080FRE17X, VS9040FRE17, VS9080BREI, VS-9080BREIM, VS9080FRE17		

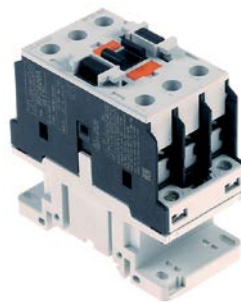

1

código	380721	referencia	961.043.00
descripción	contactor de potencia AC1 45A 230VAC (AC3/400V) 26A/13kW contactos principales 3NO contactos auxiliares empalme empalme atornillado tipo BF2600A230		
Para modelos:	VS9080PEI150		

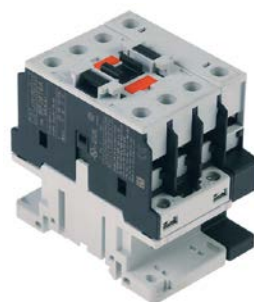

1

código	380787	referencia	961.005.00
descripción	contactor de potencia AC1 45A 230VAC (AC3/400V) 26A/13kW contactos principales 4NO empalme empalme atornillado tipo BF26T4A230		
Para modelos:	VS7040FRE17X, VS7080FRE17X, VS9040FRE17, VS9040FRE21, VS-9080FRE17, VS9080FRE21		

SIEMENS

contactores de potencia



1

código	381387	referencia	73350
descripción	contactor de potencia AC1 22A 230VAC (AC3/400V) 4kW contactos principales 3NO contactos auxiliares 1NO empalme empalme atornillado tipo 3RT2016-1AP01		
Para modelos:	GLB0041, GLB0043C-60Hz, GLB0047		



1

código	380389	referencia	229037
descripción	contactor de potencia AC1 22A 230VAC (AC3/400V) 9A/4kW contactos principales 3NO contactos auxiliares 1NO empalme empalme atornillado tipo 3RT10-16-1AP01		
Para modelos:	GLB0040, GLB0041, GLB0042, GLB0043C, GLB0044C		



1

código	380390	referencia	80351
descripción	contactor de potencia AC1 40A 230VAC (AC3/400V) 12A/5,5kW contactos principales 3NO contactos auxiliares empalme empalme atornillado tipo 3RT10-24-1AL20 50/60Hz		
Para modelos:	GLB0045, GLB0047, GLB0048		



1

código	380614	referencia	12024040
descripción	contactor de potencia AC1 22A 230VAC (AC3/400V) 9A/4kW contactos principales 3NO contactos auxiliares 1NO empalme grapas elásticas tipo 3RT2016-2AP01		
Para modelos:	AIC0037-F, AIC0039-F, AIC0071-F, AIC0072-F, GLB0071-F, GLB0080, GLB0082		



1

código	381543	referencia	12041014
descripción	contactor de potencia AC1 40A 230VAC (AC3/400V) 5.5kW contactos principales 3NO contactos auxiliares 1NO/1NC empalme conexión enchufable tipo 3RT2024-2AL20		
Para modelos:	AIC0041-F, AIC0043-F, AIC0073-F, AIC0074-F		



1

código	380957	referencia	927160
descripción	contactor de potencia AC1 22A 24VAC (AC3/400V) 12A/5,5kW contactos principales 3NO contactos auxiliares 1NO empalme empalme atornillado tipo 3RT10-17-1AB01 50/60Hz		
Para modelos:	GLB0049, GLB0050, GLB0051		

contactores pequeños



1

código	380696	referencia	12024012
descripción	contactor pequeño aliment. 230V (AC3/400V) 9A/4kW contactos principales 3NO contactos auxiliares 1NC empalme conector Faston 6,3mm AC1 16A		
Para modelos:	GLB0071-F		



1

código	381393	referencia	73351
descripción	contactor de potencia AC1 40A 230VAC (AC3/400V) 12A/5,5kW contactos principales 3NO contactos auxiliares 1NC/1NO empalme atornillado tipo 3RT2024-1AL20		
Para modelos:	GLB0043C-60Hz, GLB0047		



guardamotores



1

código	380541	referencia	927368 DEI35
descripción	guardamotor tipo 3RV1011-0JA10 margen de ajuste 0.7-1A (AC3/400V) 0.25kW		
Para modelos:	GLB0045, GLB0047, GLB0048, GLB0049, GLB0050, GLB0051		

relés

relés de potencia

con sujeción riel DIN

arriba



1

código	380809	referencia	12023706 12034668
descripción	relé de potencia FINDER 230VAC 16A 2NO empalme conector Faston 6,3mm lengüeta de sujeción N° fabricante 62.82.8.230.0307		
Para modelos:	BKZ0027-F, BKZ0040, GLB0067-F, GLB0069-F		

lateral



1

código	380313	referencia	229036
descripción	relé de potencia FINDER 230VAC 16A 3CO empalme conector Faston riel DIN N° fabricante 62.83.8.230.0008		
Para modelos:	GLB0045, GLB0047, GLB0048		

con lengüeta de sujeción



1

código	380139	referencia	929115
descripción	relé de potencia FINDER 230VAC 16A 2CO empalme F6,3 lengüeta de sujeción medidas 68x38,2x35,8mm N° fabricante 62.82.8.230.0000		
Para modelos:	GLB0040, GLB0041, GLB0042, GLB0043C, GLB0044C, GLB0047, GLB0048		



1

código	380808	referencia	461.063.00
descripción	relé de potencia FINDER 230VAC 16A 3CO empalme conector Faston 6,3mm lengüeta de sujeción N° fabricante 62.83.8.230.0000		
Para modelos:	VS7080BREIM, VS7080BRGIM, VS9080BREIM, VS9080BRGIM		



1

código	380185	referencia	229029 DER111
descripción	relé de potencia Italiana Relè 230VAC 30A 1NO empalme F6,3 lengüeta de sujeción medidas 36,5x32,2x51,8mm N° fabricante A10-230AC-FA		
Para modelos:	GLB0040, GLB0047, GLB0048		

con contactos enchufables

conectores redondos, 8 contactos



1

código	380951	referencia	961.036.00
descripción	relé de potencia FINDER 230VAC 10A 2CO empalme empalme enchufable redondo 8 polos N° fabricante 60.12.4.101.0040 90.26/ ZVE8 250V		
Para modelos:	VS7080PEI50, VS7080PGI50, VS9080PEI150, VS9080PGI150		



portarelés



1

código	380638	referencia	961.037.00
descripción	zócalo de relé 8 polos medidas 51x41x23mm 250V 10A FINDER N° fabricante 90.26		
Para modelos:	VS7080PEI50, VS7080PGI50, VS9080PEI150, VS9080PGI150		

transformadores

transformadores abiertos

con borne de empalme



1

código	400887	referencia	12024173
descripción	transformador primaria 230VAC secundaria 12/24VAC 65VA empalme atornillado 50-60Hz		
Para modelos:	AIC0037-F, AIC0038-F, AIC0039-F, AIC0040-F, AIC0041-F, AIC0042-F, AIC0043-F, AIC0044-F, AIC0045-F, AIC0046-F, AIC0071-F, AIC0072-F, AIC0073-F, AIC0074-F, AIC0075-F, AIC0076-F, AIC0077-F, AIC0078-F, AIC0079-F, AIC0080-F		

alimentadores



1

código	378362	referencia	B00LA111
descripción	alimentador primaria 100-240VAC secundaria 12VDC 50VA secundaria 4.2A H 40mm L 130mm An 100mm empalme atornillado 50-60Hz tipo NES-50-12		
Para modelos:	BMB0037-F, BNA0064-F, BNA0065-F, BNA0066-F		

controladores electrónicos



DIXELL

controladores de punto de refrigeración

accesorios



1

código	381247	referencia	A00DJ108
descripción	cable de datos DIXELL		
Para modelos:	BMA0008-F, BMA0010-F, BMA0021-F, BMA0022-F, BMA0024-F, BMA0025-F, BMA0026-F, BMA0027-F, BMA0028-F, BMA0032-F, BMA0035-F, BMA0036-F, BMB0028-F, BMB0029-F, BMB0033-F, BMB0034-F, BNA0030-F, BNA0031-F, BNA0036-F, BNA0037-F, BNA0044-F, BNA0045-F, BNA0056-F, BNZ0001-F, BNZ0002-F, BNZ0003-F, BNZ0004-F, BNZ0005-F, BNZ0006-F, BNZ0007-F, BNZ0008-F, CCZ0036-F, CCZ0037-F, PB9RI-F, VTGB2A-F, VTGB2-F, VTGB3A-F, VTGB3-F, VTGB4A-F, VTGB4-F		
accesorios para	381247		
	código	381245	referencia —
	display DIXELL DX60 medida de montaje 157x28mm profundidad de montaje 20mm aliment.V tensión salidas de relé protección IP00°C display 3½ dígitos		
	código	381246	referencia —
	controlador de punto de refrigeración DIXELL XW60K-5L1CO medida de montaje 140x110mm profundidad de montaje 60mm aliment. 230V tensión AC NTC salidas de relé 4 NO-20A(8) NO-16A(5) NO-8A(3) NO-16A(5) NTC NTC DI DI presente protección -40 a 110°C display DX60		

EVCO - EVERY CONTROL

controladores de punto de refrigeración

versión empotrada 2 piezas



1

código	403412	referencia	A00DJ120
descripción	placa de teclado barra fría BGL2-VT incl. panel de mando pos. de montaje horizontal tazas 6		
Para modelos:	BMA0026-F, BMA0032-F, BMA0035-F, BMB0028-F, BMB0029-F, BMB0033-F, BMB0034-F, BMB0035-F, BMC0012-F, BMC0015-F, BNA0030-F, BNA0031-F, BNA0036-F, BNA0037-F, BNA0044-F, BNA0045-F, BNZ0001-F, BNZ0002-F, BNZ0003-F, BNZ0005-F, BNZ0006-F, BNZ0007-F, CCZ0036-F, CCZ0037-F, VTGB2A-F, VTGB3A-F, VTGB4A-F		
accesorios para	403412		
	código	381249	referencia A00DJ109
	sensor de temperatura NTC 10kOhm cable PVC sonda -40 a +110°C cable -10 a 100°C empalme de dos hilos rosca bulbo ø6x14mm longitud de cable 3m		



sensores

sensores universales

sondas de temperatura



código	379160	referencia	A00DJ102
descripción	sensor de temperatura NTC 10kOhm cable termoplástico sonda -40 a +110°C cable -40 a +110°C bulbo ø6x14mm longitud de cable 1.5m sin racor de dos hilos		
Para modelos:	BMA0008-F, BMA0010-F, BMA0029-F, BMB0030-F, BMB0035-F, BMB0036-F, BMB0037-F, BMC0012-F, BMC0014-F, BMC0016-F, BNA0036-F, BNA0037-F, BNA0045-F, BNA0052-F, BNA0053-F, BNA0054-F, BNA0055-F, BNA0057-F, BNA0064-F, BNA0065-F, BNA0066-F, BNB0010-F, BNB0011-F, BNB0012-F, BNB0013-F, BNB0014-F, BNB0015-F, BNZ0007-F, CCZ0036-F, CCZ0037-F, PB9RI-F, VTGB4A-F		

sensores específicos del fabricante

sensores



código	403942	referencia	231016
descripción	sensor de temperatura		
Para modelos:	GLB0041, GLB0043C-60Hz, GLB0047, GLB0049		



código	381544	referencia	12039678
descripción	sensor de temperatura empalme conector bulbo 4x540mm longitud de cable 2m		
Para modelos:	AIC0041-F, AIC0042-F, AIC0045-F, AIC0046-F, AIC0075-F, AIC0080-F		



código	403925	referencia	12041634
descripción	sensor de temperatura empalme conector bulbo ø4x362 longitud de cable 2m		
Para modelos:	AIC0071-F, AIC0072-F, AIC0073-F, AIC0074-F, AIC0076-F, AIC0077-F, AIC0078-F, AIC0079-F		



código	403924	referencia	12044609
descripción	sensor de temperatura empalme conector bulbo ø4x425mm longitud de cable 2m		
Para modelos:	AIC0037-F, AIC0038-F, AIC0039-F, AIC0040-F, AIC0043-F, AIC0044-F		



código	403929	referencia	12047675
descripción	sensor de temperatura empalme conector bulbo ø4x627 longitud de cable 2m		
Para modelos:	AIC0075-F, AIC0080-F		



código	381249	referencia	A00DJ109
descripción	sensor de temperatura NTC 10kOhm cable PVC sonda -40 a +110°C cable -10 a 100°C empalme de dos hilos rosca bulbo ø6x14mm longitud de cable 3m		
Para modelos:	BMA0008-F, BMA0010-F, BMA0021-F, BMA0022-F, BMA0024-F, BMA0025-F, BMA0027-F, BMA0028-F, BMA0029-F, BMA0032-F, BMB0028-F, BMB0029-F, BMB0030-F, BMB0033-F, BMB0035-F, BMB0036-F, BMB0037-F, BMC0012-F, BMC0014-F, BMC0015-F, BMC0016-F, BNA0030-F, BNA0031-F, BNA0036-F, BNA0037-F, BNA0044-F, BNA0045-F, BNA0052-F, BNA0053-F, BNA0054-F, BNA0055-F, BNA0056-F, BNA0057-F, BNA0064-F, BNA0065-F, BNA0066-F, BNB0010-F, BNB0011-F, BNB0012-F, BNB0013-F, BNB0014-F, BNB0015-F, BNZ0001-F, BNZ0002-F, BNZ0003-F, BNZ0004-F, BNZ0005-F, BNZ0006-F, BNZ0007-F, BNZ0008-F...(Otros modelos se puede ver en la tienda web)		



código	400910	referencia	231014
descripción	sensor de temperatura NTC 10kOhm cable silicona sonda -40 a +110°C cable -50 a +180°C empalme conector codificado rosca bulbo ø4,5x30mm longitud de cable 0.35m		
Para modelos:	GLB0040, GLB0041, GLB0042, GLB0043C, GLB0044C, GLB0045, GLB0047, GLB0048		



código	378339	referencia	12025036
descripción	sensor de temperatura NTC 64kOhm cable silicona sonda -40 a +110°C cable -50 a +180°C empalme conector rosca bulbo ø6x14mm longitud de cable 2.5m		
Para modelos:	GLB0067-F, GLB0069-F, GLB0071-F, GLB0080, GLB0081, GLB0082		



código	379525	referencia	12024642
descripción	sensor de temperatura termopar K (NiCr-Ni) cable PTFE sonda -50 a 1150°C cable -40 a +250°C empalme conector Faston 6,3mm rosca bulbo ø3x70mm longitud de cable 1m		
Para modelos:	AIC0037-F, AIC0038-F, AIC0039-F, AIC0040-F, AIC0041-F, AIC0042-F, AIC0043-F, AIC0044-F, AIC0045-F, AIC0046-F, AIC0071-F, AIC0072-F, AIC0073-F, AIC0074-F, AIC0075-F, AIC0076-F, AIC0077-F, AIC0078-F, AIC0079-F, AIC0080-F		



código	379528	referencia	12023901
descripción	sensor de temperatura termopar K (NiCr-Ni) cable PTFE sonda -50 a 1150°C cable -40 a +250°C empalme conector Faston rosca bulbo ø3x70mm longitud de cable 1.6m		
Para modelos:	AIC0037-F, AIC0038-F, AIC0039-F, AIC0040-F, AIC0041-F, AIC0042-F, AIC0043-F, AIC0044-F, AIC0045-F, AIC0046-F		



sondas al corazón

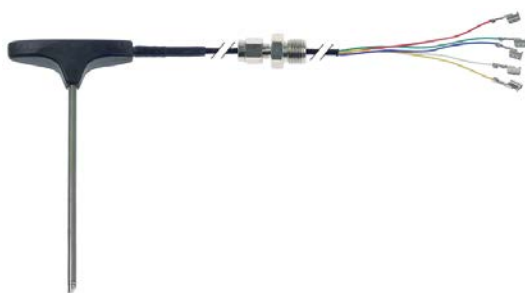

1

código	378670	referencia	12039548
descripción	sensor al corazón termopar K (NiCr-Ni) cable PTFE sonda -40 a +250°C cable -40 a +250°C empalme de cinco hilos bulbo ø4x100mm rosca 1/4" longitud de cable 2m asidero ømm longitud de asidero 55mm sensor multipunto		
Para modelos:	AIC0037-F, AIC0038-F, AIC0039-F, AIC0040-F, AIC0041-F, AIC0042-F, AIC0043-F, AIC0044-F, AIC0045-F, AIC0046-F, AIC0071-F, AIC0072-F, AIC0073-F, AIC0074-F, AIC0075-F, AIC0076-F, AIC0077-F, AIC0078-F, AIC0079-F, AIC0080-F		

accesorios

uniones roscadas



1

código	691086	referencia	12023581
descripción	tornillo de racor		
Para modelos:	AIC0037-F, AIC0038-F, AIC0039-F, AIC0040-F, AIC0041-F, AIC0042-F, AIC0043-F, AIC0044-F, AIC0045-F, AIC0046-F, AIC0071-F, AIC0072-F, AIC0073-F, AIC0074-F, AIC0075-F, AIC0076-F, AIC0077-F, AIC0078-F, AIC0079-F, AIC0080-F		

otros



1

código	691085	referencia	12024247
descripción	junta anular para sonda		
Para modelos:	AIC0037-F, AIC0038-F, AIC0039-F, AIC0040-F, AIC0041-F, AIC0042-F, AIC0043-F, AIC0044-F, AIC0045-F, AIC0046-F, AIC0071-F, AIC0072-F, AIC0073-F, AIC0074-F, AIC0075-F, AIC0076-F, AIC0077-F, AIC0078-F, AIC0079-F, AIC0080-F		

electrónicas

EPROMs



1

código	403244	referencia	81008
descripción	EPROM para lavavajillas CODE 81008		
Para modelos:	GLB0045, GLB0047, GLB0048		



1

código	403241	referencia	81001
descripción	EPROM tipo U61E para lavavajillas CODE 81001-3		
Para modelos:	GLB0040, GLB0041, GLB0042, GLB0043C, GLB0044C		

convertidores de frecuencia



1

código	403922	referencia	12048794
descripción	convertidor de frecuencia con disipador para horno a vapor combinado 200-240V 47-63 Hz L 150mm An 115mm H 90mm frecuencia output 0-550Hz 6.2A corriente de salida 2.3A SIEMENS SINAMICS G110 CPM110 AIN 6SL3211-0AB13-7UA1		
Para modelos:	AIC0037-F, AIC0071-F		



1

código	403935	referencia	12048798
descripción	convertidor de frecuencia con disipador para horno a vapor combinado 200-240V L 150mm An 115mm H 90mm frecuencia output 0-550Hz 6.2A corriente de salida 2.3A		
Para modelos:	AIC0038-F, AIC0039-F, AIC0040-F, AIC0041-F, AIC0042-F, AIC0043-F, AIC0044-F, AIC0045-F, AIC0046-F, AIC0072-F, AIC0073-F, AIC0074-F, AIC0075-F, AIC0076-F, AIC0077-F, AIC0078-F, AIC0079-F, AIC0080-F		

placas electrónicas



1

código	403076	referencia	12046671
descripción	placa de display horno a vapor combinado COE061 L 160mm An 110mm con potenciómetro		
Para modelos:	AIC0071-F, AIC0072-F, AIC0073-F, AIC0074-F, AIC0075-F, AIC0076-F, AIC0077-F, AIC0078-F, AIC0079-F, AIC0080-F		
accesorios para	403076		
	código	referencia	—
			placa electrónica para horno a vapor combinado



1

código	403237	referencia	12024028
descripción	placa de display lavavajillas AD15/21/48 L 100mm An 35mm		
Para modelos:	GLB0067-F, GLB0069-F, GLB0071-F		

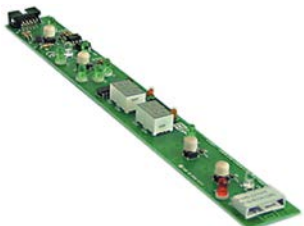





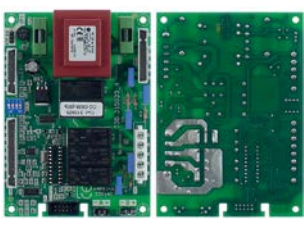

1

código	400897	referencia	227059
descripción	placa de display lavavajillas GS 60		
Para modelos:	GLB0040		
accesorios para	400897		
	código	referencia	926272
			cable de cinta plana 10 polos L 3000mm tipo de conector cifrado 2 filas número de polos de conector 10



1

código	400899	referencia	215023
descripción	placa de potencia lavavajillas LP10/20/30 sin EPROM		
Para modelos:	GLB0040, GLB0041, GLB0042, GLB0043C, GLB0044C, GLB0045, GLB0047, GLB0048		
accesorios para	400899		
	código	referencia	—
			conector enchufable 5 polos
	código	referencia	—
			EPROM CODE 225029-3
	código	referencia	—
			EPROM CODE 81000-1
	código	referencia	81001
			EPROM tipo U61E para lavavajillas CODE 81001-3
	código	referencia	—
			casquillo redondo



1

código	400898	referencia	80889 80900
descripción	placa de teclado lavavajillas LP10/20/30 con indicación		
Para modelos:	GLB0041, GLB0042, GLB0043C, GLB0043C-60Hz, GLB0044C, GLB0045, GLB0047, GLB0048		
accesorios para	400898		
	código	referencia	41523
			cable de cinta plana 10 polos L 1200mm tipo de conector 2 filas codificado UE 1m



1

código	401451	referencia	663.048.00
descripción	placa electrónica cocina vitrocerámica serie 110/920		
Para modelos:	VS9040PVET, VS9080CFVE, VS9080PVET		

1

código	402225	referencia	12046670
descripción	placa electrónica horno a vapor combinado VE101/202		
Para modelos:	AIC0037-F, AIC0038-F, AIC0039-F, AIC0040-F, AIC0041-F, AIC0042-F, AIC0043-F, AIC0044-F, AIC0045-F, AIC0046-F		

1

código	361978	referencia	91310260
descripción	placa electrónica horno para pizzas/formadora de pizzas L 125mm An 108mm con Display tazas 6		
Para modelos:	CBC0001, CBC0002, CBC0003, CBC0004		

1

código	403308	referencia	12008750
descripción	placa electrónica lavavajillas AD-72/48/64 L 128mm An 118mm apto para FAGOR con carcasa H 55mm para lavavajillas UE 1 pzs		
Para modelos:	GLB0067-F, GLB0069-F, GLB0082		

1

código	401049	referencia	215022
descripción	placa electrónica lavavajillas LP10/20/30		
Para modelos:	GLB0040, GLB0041, GLB0042, GLB0043C, GLB0044C, GLB0045, GLB0047, GLB0048		

1

código	403572	referencia	215032-1
descripción	placa electrónica lavavajillas Protech 1113/611 TR10 L 178mm An 125mm		
Para modelos:	GLB0043C-60Hz, GLB0047		

1

código	403923	referencia	12046673
descripción	placa electrónica para horno a vapor combinado 61/101 L 150mm An 100mm para FAGOR		
Para modelos:	AIC0038-F, AIC0040-F, AIC0042-F, AIC0044-F, AIC0046-F, AIC0076-F, AIC0077-F, AIC0078-F, AIC0079-F, AIC0080-F		

1

código	403934	referencia	12046659
descripción	placa electrónica para horno a vapor combinado L 155mm An 100mm		
Para modelos:	AIC0037-F, AIC0038-F, AIC0039-F, AIC0040-F, AIC0041-F, AIC0042-F, AIC0043-F, AIC0044-F, AIC0045-F, AIC0046-F, AIC0071-F, AIC0072-F, AIC0073-F, AIC0074-F, AIC0075-F, AIC0076-F, AIC0077-F, AIC0078-F, AIC0079-F, AIC0080-F		



teclados

membranas de teclado



1

código	403710	referencia	A00DJ105
descripción	membrana de teclado para frigorífico para FRENEX		
Para modelos:	BMA0008-F, BMA0010-F, BMA0021-F, BMA0022-F, BMA0024-F, BMA0025-F, BMA0026-F, BMA0027-F, BMA0028-F, BMA0029-F, BMA0032-F, BMA0035-F, BMA0036-F, BMB0028-F, BMB0029-F, BMB0030-F, BMB0033-F, BMB0034-F, BMB0035-F, BMB0036-F, BMB0037-F, BMC0012-F, BMC0014-F, BMC0015-F, BMC0016-F, BNA0030-F, BNA0031-F, BNA0036-F, BNA0037-F, BNA0044-F, BNA0045-F, BNA0056-F, BNA0064-F, BNA0065-F, BNA0066-F, BNZ0001-F, BNZ0002-F, BNZ0003-F, BNZ0004-F, BNZ0005-F, BNZ0006-F, BNZ0007-F, BNZ0008-F, CCZ0036-F, CCZ0037-F, PB9RI-F, VTGB2A-F, VTGB2-F, VTGB3A-F, VTGB3-F...(Otros modelos se puede ver en la tienda web)		



1

código	403927	referencia	12044109
descripción	membrana de teclado para horno a vapor combinado negro L 540mm An 173mm		
Para modelos:	AIC0071-F, AIC0072-F, AIC0073-F, AIC0074-F, AIC0075-F		



1

código	403928	referencia	12044176
descripción	membrana de teclado para horno a vapor combinado negro L 540mm An 173mm		
Para modelos:	AIC0076-F, AIC0077-F, AIC0078-F, AIC0079-F, AIC0080-F		

válvulas magnéticas

válvulas magnéticas agua

ELBI

recto



1

código	373025	referencia	12023921
descripción	válvula magnética triple recto 230VAC entrada 3/4" salida 11,5mm DN10 ELBI		
Para modelos:	AIC0037-F, AIC0038-F, AIC0039-F, AIC0040-F, AIC0041-F, AIC0042-F, AIC0043-F, AIC0044-F, AIC0045-F, AIC0046-F		

repuestos para	373025	código	370467	referencia	—
			filtro de válvula magnética apto para ELBI		



1

código	370315	referencia	929172
descripción	válvula magnética doble recto 230VAC entrada 3/4" salida 11,5mm reducción entrada A 16l/min T máx 90°C ELBI plástico reducción entrada A negro		
Para modelos:	GLB0041, GLB0043C, GLB0044C, GLB0045, GLB0047, GLB0048		



1

código	370849	referencia	12115418
descripción	válvula magnética triple recto 220-240V/50-60Hz entrada 3/4" salida 10.5 T máx 90°C ciclo de trabajo 100% ELBI 369 plástico reducción entrada A negro		
Para modelos:	AIC0037-F, AIC0038-F, AIC0039-F, AIC0040-F, AIC0041-F, AIC0042-F, AIC0044-F, AIC0045-F, AIC0046-F		

recambios y accesorios

reducciones

salida



1





código	371260	referencia	12008692
descripción	reducción tipo ELBI velocidad de flujo 0.5l/min margen de presión 0 a 10bar tolerancia ±15/25% rojo		
Para modelos:	AIC0078-F, AIC0079-F, AIC0080-F		















TP



1

código	370017	referencia	12025161 240018
descripción	válvula magnética simple recto 230VAC entrada 3/4" salida 11,5mm DN10 TP p máx. 10bar		
Para modelos:	AIC0037-F, AIC0038-F, AIC0039-F, AIC0040-F, AIC0041-F, AIC0042-F, AIC0043-F, AIC0044-F, AIC0045-F, AIC0046-F, AIC0071-F, AIC0072-F, AIC0073-F, AIC0074-F, AIC0075-F, AIC0076-F, AIC0077-F, AIC0078-F, AIC0079-F, AIC0080-F, GLB0040, GLB0043C-60Hz		
repuestos para	370017		
	código	371013	referencia —
		bobina magnética TP 230VAC 50/60Hz	
accesorios para	370017		

	código	371220	referencia	—
		reducción TP velocidad de flujo 3l/min rojo tolerancia ±15%		
	código	371221	referencia	—
		reducción TP velocidad de flujo 5.5l/min amarillo tolerancia ±15%		
	código	371222	referencia	—
		reducción TP velocidad de flujo 6l/min gris tolerancia ±15%		
	código	371223	referencia	—
		reducción TP velocidad de flujo 10l/min blanco tolerancia ±15%		

accesorios para	370017		
	código	371224	referencia —
		reducción TP velocidad de flujo 12l/min bronce tolerancia ±15%	
	código	371225	referencia —
		reducción TP velocidad de flujo 16l/min marrón claro tolerancia ±15%	
	código	371226	referencia —
		reducción TP velocidad de flujo 20l/min rojo tolerancia ±15%	
	código	371230	referencia —
		reducción TP velocidad de flujo 0.25l/min rojo tolerancia ±25%	
	código	371231	referencia —
		reducción TP velocidad de flujo 0.35l/min violeta tolerancia ±25%	
	código	371232	referencia —
		reducción TP velocidad de flujo 0.5l/min naranja tolerancia ±25%	
	código	371233	referencia —
		reducción TP velocidad de flujo 0.8l/min blanco tolerancia ±25%	
	código	371234	referencia 12025263
		reducción TP velocidad de flujo 1l/min azul claro tolerancia ±25%	
	código	371235	referencia —
		reducción TP velocidad de flujo 1.2l/min marrón tolerancia ±25%	
	código	371236	referencia —
		reducción TP velocidad de flujo 1.5l/min marrón claro tolerancia ±25%	
	código	371237	referencia —
		reducción TP velocidad de flujo 2.5l/min amarillo tolerancia ±25%	
	código	371238	referencia —
		reducción TP velocidad de flujo 3.4l/min verde oscuro tolerancia ±25%	
	código	371239	referencia —
		reducción TP velocidad de flujo 5l/min negro tolerancia ±25%	
	código	371240	referencia —
		reducción TP velocidad de flujo 8l/min azul tolerancia ±20%	



1

código	370860	referencia	256.347.00
descripción	válvula magnética simple acodado 230VAC entrada 3/4" salida 11,5mm DN10 TP		
Para modelos:	VS7080BREI, VS7080BREIM, VS7080BRGI, VS7080BRGIM, VS7080PEI50, VS7080PG50, VS7080PGI50, VS9080BREI, VS9080BREIM, VS9080BRGI, VS9080BRGIM, VS9080PEI150, VS9080PGI150		



recambios y accesorios

reducciones

salida



1

código	371234	referencia	12025263
descripción	reducción TP velocidad de flujo 1l/min azul claro tolerancia ±25%		
Para modelos:	AIC0037-F, AIC0038-F, AIC0039-F, AIC0040-F, AIC0041-F, AIC0042-F, AIC0043-F, AIC0044-F, AIC0045-F, AIC0046-F, AIC0071-F, AIC0072-F, AIC0073-F, AIC0074-F, AIC0075-F		



1

código	691081	referencia	12024509
descripción	reducción velocidad de flujo 0.25l/min verde tolerancia ±25%		
Para modelos:	AIC0037-F, AIC0038-F, AIC0039-F, AIC0040-F, AIC0041-F, AIC0042-F, AIC0043-F, AIC0044-F, AIC0046-F, AIC0071-F, AIC0072-F, AIC0073-F, AIC0074-F, AIC0076-F, AIC0077-F		



1

código	691082	referencia	12024045
descripción	reducción velocidad de flujo 8l/min violeta tolerancia ±25%		
Para modelos:	AIC0037-F, AIC0038-F, AIC0039-F, AIC0040-F, AIC0041-F, AIC0042-F, AIC0044-F, AIC0045-F, AIC0046-F		

metal

PARKER

2 vías

serie VE-123



1

código	370727	referencia	927142
descripción	válvula magnética latón 2vías 24VAC entrada 1/2" H salida 1/2" H empalme 1/2" L 72mm DN 13mm T máx 140°C -10 a 140°C PARKER serie VE123 tipo de bobina ZB09 membrana Viton p máx. 5bar 50/60Hz 24V tensión AC		
Para modelos:	GLB0049, GLB0050, GLB0051		

válvulas magnéticas refrigeración

CASTEL

válvulas



1

código	370402	referencia	A00SL100
descripción	válvula magnética CASTEL tipo 1028/2 230V p máx. 45bar 1/4" empalme 1/4" -35 a 110°C refrigeración cobre/latón DN 6.35mm		
Para modelos:	BMA0021-F, BMA0022-F, BMA0024-F, BMA0025-F, BMA0026-F, BMA0027-F, BMA0028-F, BMA0029-F, BMA0032-F, BMB0028-F, BMB0029-F, BMB0033-F, BMB0034-F, BMC0014-F, BMC0016-F, BNA0030-F, BNA0031-F, BNA0036-F, BNA0044-F, CCZ0036-F, CCZ0037-F		

SANHUA

válvulas



1

código	370837	referencia	A00SL101
descripción	válvula magnética SANHUA tipo MDF-A03-3H003 230V p máx. 45bar L 112mm -35 a 110°C refrigeración cobre/latón		
Para modelos:	BMA0035-F, BMA0036-F, BMB0030-F, BMC0012-F, BMC0014-F, BMC0015-F, BMC0016-F, BNZ0004-F, BNZ0008-F, VTGB2A-F, VTGB2-F, VTGB3A-F, VTGB3-F, VTGB4-F		

presostatos

para sistemas de lavado

ø58mm con conector Faston 6,3mm

con empalme horizontal



1

código	541002	referencia	224002
descripción	presostato margen de presión 110/60mbar empalme 6mm ø 58mm conexión de presión horizontal sistemas de lavado empalme presión ø 6mm		
Para modelos:	GLB0040, GLB0043C-60Hz		



1

código	541105	referencia	926049
descripción	presostato margen de presión 180/70mbar empalme 6mm ø 58mm conexión de presión horizontal sistemas de lavado		
Para modelos:	GLB0041, GLB0042, GLB0043C, GLB0043C-60Hz, GLB0044C, GLB0045, GLB0047, GLB0048, GLB0049, GLB0050, GLB0051		



1

código	541001	referencia	224004
descripción	presostato margen de presión 35/17mbar empalme 6mm ø 58mm conexión de presión horizontal sistemas de lavado		
Para modelos:	GLB0040, GLB0041, GLB0042, GLB0043C, GLB0044C		

accesorios



1

código	541109	referencia	12023510
descripción	pieza Y plástico tubo ø 8-6-8mm para presóstato		
Para modelos:	GLB0067-F, GLB0069-F		

para regulación vapor



1

código	542406	referencia	962.001.00
descripción	presostato ø 45mm marmita margen de presión 0,45/0,4bar empalme 1/4" p máx. 1/1bar		
Para modelos:	VS70120CFGG, VS7080PEI50, VS7080PGI50, VS90120CFGG, VS9080PEI150, VS9080PGI150		

accesorios



1

código	542440	referencia	931.217.00
descripción	unión roscada para presóstatos ø 6mm 3/8"		
Para modelos:	VS9080PEI150, VS9080PGI150		

electródos



1

código	400884	referencia	12023573
descripción	electrodo de nivel a presión longitud total 105mm sonda L 95mm largo del bulbo asiladomm empalme M4		
Para modelos:	AIC0037-F, AIC0038-F, AIC0039-F, AIC0040-F, AIC0041-F, AIC0042-F, AIC0043-F, AIC0044-F, AIC0045-F, AIC0046-F		



1

código	400885	referencia	12023574
descripción	electrodo de nivel a presión longitud total 120mm sonda L 110mm largo del bulbo asiladomm empalme M4		
Para modelos:	AIC0037-F, AIC0038-F, AIC0039-F, AIC0040-F, AIC0041-F, AIC0042-F, AIC0043-F, AIC0044-F, AIC0045-F, AIC0046-F		



1

código	400886	referencia	12023575
descripción	electrodo de nivel a presión longitud total 130mm sonda L 120mm largo del bulbo asiladomm empalme M4		
Para modelos:	AIC0037-F, AIC0038-F, AIC0039-F, AIC0040-F, AIC0041-F, AIC0042-F, AIC0043-F, AIC0044-F, AIC0045-F, AIC0046-F		



1

código	694804	referencia	12024460
descripción	orificio de paso para electrodos de nivel fijación atornillada longitud total 49mm plástico ø 8mm		
Para modelos:	AIC0037-F, AIC0038-F, AIC0039-F, AIC0040-F, AIC0041-F, AIC0042-F, AIC0043-F, AIC0044-F, AIC0045-F, AIC0046-F		



flujómetros y sensores de caudal

flujómetros

otros



código	402680	referencia	240998
descripción	flujómetro margen de presión 0,2-10bar empalme 10mm L 69mm		
Para modelos:	GLB0049, GLB0050, GLB0051		

unidades condensadoras

código	379304***	referencia	123456
descripción			
Para modelos:			

código	379304***	referencia	123456
descripción			
Para modelos:			

código	379304***	referencia	123456
descripción			
Para modelos:			

compresores

EMBRACO / ASPERA

R134A

HBP monofásico

Temperatura alta de evaporación superior a -15°C



código	605189	referencia	A00KO110
descripción	compresor refrigerante R134a tipo EMT6160Z 220-240V 50Hz HBP 7.8kg 1/4HP capacidad cilindro 6.76 cm ³ CSIR H 166mmWWW 325W 412W 513W 630W 762W 910W temperatura ambiente máx. 45°C		
Para modelos:	CCZ0036-F		



código	605135	referencia	A00KO101
descripción	compresor refrigerante R134a tipo EMT6170Z 220-240V 50Hz HBP completamente hermético 8.1kg 1/6HP capacidad cilindro 7.69 cm ³ CSIR H 166mmWWW 281W 358W 448W 550W 663W 982W		
Para modelos:	BMA0008-F, BMA0010-F, BMA0021-F, BMA0022-F, BMA0024-F, BMA0025-F, BMA0027-F, BMA0029-F, BMA0035-F, BMC0014-F, BMC0016-F, BNA0036-F, BNA0037-F, BNA0044-F, BNA0045-F, BNA0054-F, BNA0055-F, BNA0056-F, BNA0057-F, BNA0065-F, BNA0066-F, BNZ0005-F, BNZ0006-F, CCZ0037-F		



código	605208	referencia	A00KO109
descripción	compresor refrigerante R134a tipo NEK6210Z-A 220-240V 50Hz HBP 11kg 1/3HP capacidad cilindro 12.1 cm ³ CSIR H 200mmWWW 364W 485W 636W 818W 1030W 1273W metodo de test EN 12900 temperatura ambiente máx. 55°C		
Para modelos:	BMA0028-F, BMA0036-F		

HMBP monofásico

Temperatura alta/media de evaporación superior a -20/-15 °C



código	605016	referencia	A00KO100
descripción	compresor refrigerante R134a tipo EM65HHR 220-240V 50Hz HBP completamente hermético 7.62kg 1/6HP capacidad cilindro 5.54 cm ³ CSIRWWW 287W 389W 499W 617W 742W metodo de test ASHRAE 842W		
Para modelos:	BMC0012-F, BMC0016-F, BNA0030-F, BNA0031-F, BNA0052-F, BNA0053-F, BNA0064-F, BNZ0001-F, BNZ0002-F, CCZ0036-F		



R404a/R507

LBP monofásico

Temperatura baja de evaporación inferior a -20°C



código	605256	referencia	A00KO105
descripción	compresor refrigerante R404A tipo NEU2140GK 220-240V 50Hz LBP 10.6kg 1/2HP capacidad cilindro 8.77 cm ³ CSIR H 206mm 326W 421W 531W 658W 801W 1123W metodo de test EN 12900		
Para modelos:	BMB0030-F, BMC0012-F, BMC0016-F		



código	605144	referencia	A00KO102
descripción	compresor refrigerante R404a/R507 tipo NEK2168GK 220-240V 50Hz LBP 22.9kg 3/4HP capacidad cilindro 14.28 cm ³ CSR H 200mm 345W 454W 587W 742W 921W 1123W 1123W		
Para modelos:	BMA0026-F, BMA0032-F, BMB0033-F, BMC0014-F, BMC0015-F, PB9RI-F		



código	605174	referencia	A00KO103
descripción	compresor refrigerante R404a/R507 tipo NJ2192GK 220-240V 50Hz LBP 20.4kg 1 1/4HP capacidad cilindro 26.2 cm ³ CSR H 265mm 685W 989W 1342W 1745W 2196W 2196W		
Para modelos:	BMB0028-F, BMB0029-F, BMB0034-F, BMB0035-F, BMB0036-F, BMB0037-F, BMC0015-F, BNB0010-F, BNB0011-F, BNB0012-F, BNB0013-F, BNB0014-F, BNB0015-F, BNZ0004-F, BNZ0007-F, BNZ0008-F, VTGB2A-F, VTGB2-F, VTGB3A-F, VTGB3-F, VTGB4A-F, VTGB4-F		

ventiladores

ventilador axial

importación



código	602165	referencia	764.055.00
descripción	ventilador axial L 119mm An 119mm H 38mm 230VAC 50/60Hz 15/14W N° fabricante 4715MS-23T-B5A empalme conector Faston 2,8mm NMB rodete ventilador ø 110mm		
Para modelos:	VS7080TPET, VS7080TPFE, VS9080TPET, VS9080TPFE		



código	601080 ¹	referencia	12023862	
descripción	ventilador axial L 119mm An 119mm H 38mm 230VAC 50/60Hz 23/20W cojinete rodamiento de bolas empalme conector Faston 2,8mm metal ADDA rodete ventilador ø 110mm resis.a la temp. 70°C			
Para modelos:	AIC0037-F, AIC0038-F, AIC0039-F, AIC0040-F, AIC0041-F, AIC0042-F, AIC0071-F, AIC0072-F, AIC0073-F, AIC0076-F, AIC0077-F, AIC0078-F			
accesorios para	601080			
	código	550898	referencia	—
	cable de conexión longitud del cable 2000mm empalme F 2,8 distancia de empalme 7.9mm para ventilador axial			
	código	692519	referencia	—
	rejilla de protección L 120mm An 120mm plástico			

¹con rodamiento de bolas

ventiladores para frigoríficos

motores refrigeración universales

ELCO

serie N - estándar

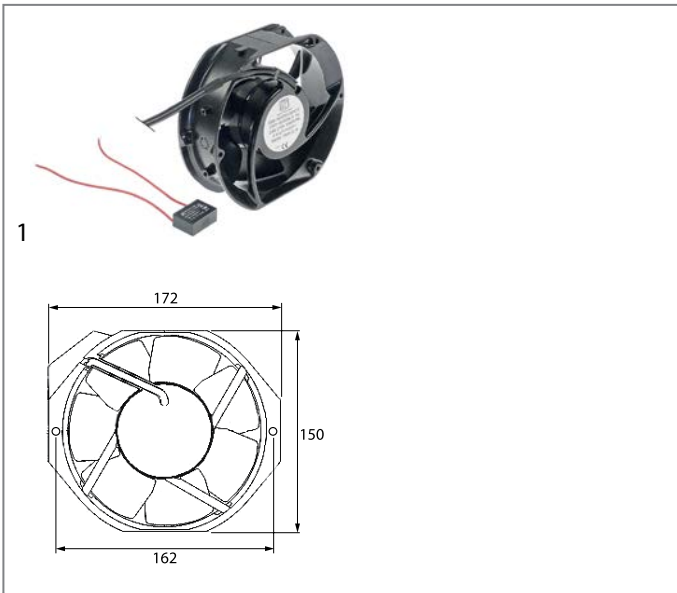

código	601932	referencia	A00FA107
descripción	ventilador axial L 172mm An 150mm H 51mm 230 50/60Hz 23W cojinete rodamiento de bolas N° fabricante AC17251CU7C1Y empalme cable 1000mm MA-VIB caudal 336/390m³/h		
Para modelos:	BMA0008-F, BMA0010-F, BMA0026-F, BMA0027-F, BMA0028-F, BMB0034-F, BMB0035-F, BMB0036-F, BMB0037-F, BMC0015-F, PB9RI-F		

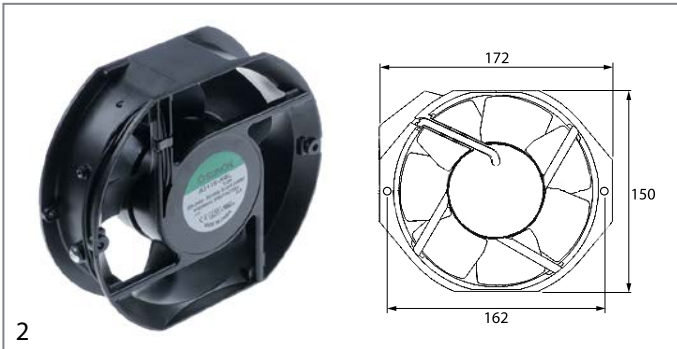

código	601654 ¹	referencia	12024106
descripción	ventilador axial L 172mm An 150mm H 51mm 230VAC 50/60Hz 28/24W cojinete rodamiento de bolas N° fabricante A2175-HBL T.GN empalme cable longitud del cable 280mm metal SUNON rodete ventilador ø 142mm resis.a la temp. -10 a +80°C distancia de sujeción 162mm		
Para modelos:	AIC0043-F, AIC0044-F, AIC0045-F, AIC0046-F, AIC0074-F, AIC0075-F, AIC0079-F, AIC0080-F		

¹con rodamiento de bolas





código	601930	referencia	A00FA109 A00KN100-A A00KN101-A A00KN700-A
descripción	motor de ventilador ELCO 10W 230V 50/60Hz cojinete cojinete de fricción L1 55.5mm L2 91.5mm L3 119mm An 83mm longitud del cable 2000mm 1300/1550rev/min 5 opciones de montaje VN10-20/929		
Para modelos:	BMA0008-F, BMA0010-F, BMA0029-F, BMC0012-F, BMC0014-F, BMC0016-F, BNA0036-F, BNA0037-F, BNA0045-F, BNA0064-F, BNA0065-F, BNA0066-F, CCZ0036-F, CCZ0037-F		

repuestos para	601930	código	601284	referencia	—
	rodete ventilador aspirante ø 254mm fijación asta 25.4mm inclinación de la pala 28° An 42mm aluminio				



código	601928	referencia	A00FA104 A00KN102-A A00KN153-A A00KN701-A
descripción	motor de ventilador ELCO 16W 230V 50Hz cojinete cojinete de fricción L1 55.5mm L2 91.5mm L3 119mm An 83mm longitud del cable 2000mm 1300/1550rev/min 5 opciones de montaje VNT16-25/1774		
Para modelos:	BMB0030-F, BMB0035-F, BMB0036-F, BMB0037-F, BMC0012-F, BMC0016-F, BNZ0007-F, PB9RI-F, VTGB4A-F		

repuestos para	601928	código	601284	referencia	—
	rodete ventilador aspirante ø 254mm fijación asta 25.4mm inclinación de la pala 28° An 42mm aluminio				
	código	601413	referencia	—	
	placa de sujeción apto para rodete ventilador ø ext. 32mm eje ø 7 distancia de sujeción 26mm				

motores de refrigeración completos



1

código	601511	referencia	12038161
descripción	ventilador 230V 10W 50Hz rodete ventilador ø 195mm inclinación de la pala 22° empalme cable 500mm		
Para modelos:	BKZ0022-F		

ventiladores de refrigeración

HIDRIA

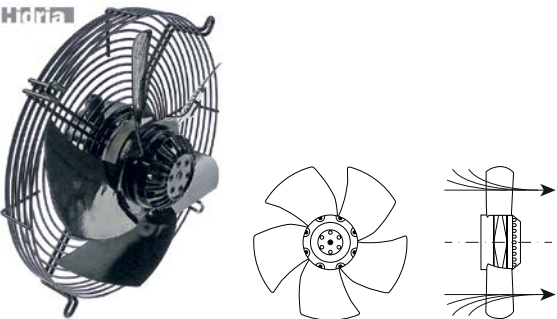

1

código	601811	referencia	12026785
descripción	ventilador tipo R09R-3030HP-4M-2543 rodete ventilador ø 300mm 230V 50/60Hz 65/90W condensador apropiado 2.5µF HIDRIA apto para abatidor de temperatura para FRIULINOX 1400/1500rev/min soplado H 138mm longitud del cable mm distancia de sujeción 265mm		
Para modelos:	BKZ0022-F, BKZ0023-F		

ventiladores de refrigeración



1

código	601919	referencia	A00FA102 A00SHP009-A
descripción	motor de ventilador 220-230V 50-60Hz 5W eje ø 6mm eje L 14mm L 73mm An 62mm H 62mm longitud del cable 2900mm consumo de corriente 2A		
Para modelos:	BMB0030-F, BMC0014-F, BMC0016-F, BNA0030-F, BNA0031-F, BNA0036-F, BNA0037-F, BNA0044-F, BNA0045-F, BNA0052-F, BNA0053-F, BNA0054-F, BNA0055-F, BNA0056-F, BNA0057-F, BNA0064-F, BNA0065-F, BNA0066-F, BNB0010-F, BNB0011-F, BNB0012-F, BNB0013-F, BNB0014-F, BNB0015-F, BNZ0002-F, BNZ0004-F, BNZ0006-F, BNZ0007-F, BNZ0008-F, CCZ0036-F, CCZ0037-F, VTGB2A-F, VTGB2-F, VTGB3A-F, VTGB3-F, VTGB4A-F, VTGB4-F		
repuestos para	601919		
	código	601568	referencia —
	rodete ventilador soplado ø 154mm fijación asta 25.4mm inclinación de la pala 28° An 34mm aluminio		

ventiladores tangenciales

ebm-papst



1

código	601936	referencia	A00FA103
descripción	ventilador tangencial QLZ06/1800A265-2524 rodillo ø 60mm L rodillo 180mm espesor de núcleo laminado 28mm posición del motor derecho 230V/50Hz 31W refrigeración cojinete goma empalme conector Faston 6,3mm caudal 160m³/h 0 a +60°C 230V 150m³/h 50Hz		
Para modelos:	BMA0021-F, BMA0022-F, BMA0024-F, BMA0025-F, BMA0032-F, BMA0035-F, BMA0036-F, BMB0028-F, BMB0029-F, BMB0033-F, BMC0016-F		

motores de aire caliente



1

código	691049	referencia	12024510
descripción	junta radial int.ø 17mm ø ext. 28mm espesor 7mm		
Para modelos:	AIC0037-F, AIC0038-F, AIC0039-F, AIC0040-F, AIC0041-F, AIC0042-F, AIC0043-F, AIC0044-F, AIC0045-F, AIC0046-F, AIC0071-F, AIC0072-F, AIC0073-F, AIC0074-F, AIC0075-F, AIC0076-F, AIC0077-F, AIC0078-F, AIC0079-F, AIC0080-F		





1

código	602143	referencia	12024325
descripción	motor de ventilador fases 3 50Hz 0.75kW 1400rev/min L1 150mm L2 45mm L3 37mm D1 ø 17mm D2 ø 14mm 3.2A tipo 3036AB2350		
Para modelos:	AIC0037-F, AIC0038-F, AIC0039-F, AIC0040-F, AIC0041-F, AIC0042-F, AIC0043-F, AIC0044-F, AIC0045-F, AIC0046-F, AIC0071-F, AIC0072-F, AIC0073-F, AIC0074-F, AIC0075-F, AIC0076-F, AIC0077-F, AIC0078-F, AIC0079-F, AIC0080-F		



1

código	601795	referencia	12024306
descripción	rodete ventilador D1 ø 350mm H1 125mm palas 12 D2 ø 13mm D3 ø 16mm H2 15mm		
Para modelos:	AIC0037-F, AIC0039-F, AIC0040-F, AIC0041-F, AIC0042-F, AIC0043-F, AIC0044-F, AIC0045-F, AIC0046-F, AIC0071-F, AIC0072-F, AIC0073-F, AIC0074-F, AIC0075-F, AIC0077-F, AIC0078-F, AIC0079-F, AIC0080-F		



1

código	602182	referencia	12024786
descripción	rodete ventilador palas 12 D1 ø 280mm D2 ø 13mm D3 ø 16.5mm H1 128mm H2 20.5mm H3 80mm		
Para modelos:	AIC0038-F, AIC0076-F		

ventiladores radiales



1

código	602181	referencia	12039373
descripción	ventilador radial 230V tensión AC 50/60Hz 135W H1 193mm L1 182mm D1 ø 90mm B1 145mm B2 28mm H2 50mm B3 83mm H3 80mm horno a vapor combinado		
Para modelos:	AIC0046-F		



1

código	602183	referencia	12044607
descripción	ventilador radial 230V tensión AC 50Hz 55W H1 156mm L1 160mm D1 ø 126mm B1 90mm H2 50mm B3 83mm horno a vapor combinado		
Para modelos:	AIC0038-F, AIC0040-F, AIC0042-F, AIC0044-F, AIC0046-F, AIC0076-F, AIC0077-F, AIC0078-F, AIC0079-F, AIC0080-F		

accesorios en general



1

código	601933	referencia	A00EP100
descripción	cubierta de rondete de ventilador An 180mm para rodete de ventilador H 50mm distancia de sujeción 160mm		
Para modelos:	BNA0030-F, BNA0031-F, BNA0036-F, BNA0037-F, BNA0044-F, BNA0045-F, BNA0052-F, BNA0053-F, BNA0054-F, BNA0055-F, BNA0056-F, BNA0057-F, BNA0064-F, BNA0065-F, BNA0066-F, BNB0010-F, BNB0011-F, BNB0012-F, BNB0013-F, BNB0014-F, BNB0015-F, BNZ0002-F, BNZ0004-F, BNZ0006-F, BNZ0007-F, BNZ0008-F, CCZ0036-F, CCZ0037-F, VTGB2A-F, VTGB2-F, VTGB3A-F, VTGB3-F, VTGB4A-F, VTGB4-F		

			
1			
código	521073	referencia	A00EP101
descripción	cubierta de rondete de ventilador ø 290mm para ventilador de evaporador dist. del agujero 210mm plástico negro H 50mm		
Para modelos:	BMC0012-F, CCZ0036-F, CCZ0037-F		

motores



motorreductores

para sartén basculante

			
1			
código	501582	referencia	964.003.00
descripción	motorreductor tipo AO-4/M 24V para sartén basculante		
Para modelos:	VS7080BREIM, VS7080BRGIM, VS9080BREIM, VS9080BRGIM		

para hornos

para chimeneas

			
1			
código	530008	referencia	12024638
descripción	motorreductor MECHTEX tipo SOE-40 3.5W 230V tensión AC 50/60Hz 10rev/min árbol ø 6x5mm L 65mm An 51mm H 40mm motor chimenea		
Para modelos:	AIC0037-F, AIC0038-F, AIC0039-F, AIC0040-F, AIC0041-F, AIC0042-F, AIC0043-F, AIC0044-F, AIC0045-F, AIC0046-F, AIC0071-F, AIC0072-F, AIC0073-F, AIC0074-F, AIC0075-F, AIC0076-F, AIC0077-F, AIC0078-F, AIC0079-F, AIC0080-F		
repuestos para	530008		
	código	360673	referencia —
	 kit de motor piñón ø 6.8mm dientes 15 aliment. 230V tensión AC 50/60Hz sentido de rotación en sentido horario ø motor 48mm H 18.5mm tipo motor UDS40NE1RNZ165 longitud del cable 150mm con soporte		

para lavavajillas

			
1			
código	601861	referencia	927105
descripción	motorreductor FIR tipo 71-B5 180W 400V tensión AC 50/60Hz fases 3 900/1100rev/min árbol ø 14mm L 227mm para sistema de transporte sin mecanismo		
Para modelos:	GLB0045, GLB0047, GLB0048, GLB0049, GLB0050, GLB0051		

otros

			
1			
código	501518	referencia	12024754
descripción	motorreductor 230V 50/60Hz		
Para modelos:	AIC0037-F, AIC0038-F, AIC0039-F, AIC0040-F, AIC0041-F, AIC0042-F, AIC0043-F, AIC0044-F, AIC0045-F, AIC0046-F		

bombas



bombas de lavado y aclarado

FIR

bombas

			
1			
código	500037	referencia	929167
descripción	bomba entrada ø 28mm salida ø 26mm tipo 2211.1410 230V 50Hz fases 1 0,074kW 0.1PS L 190mm dirección de rodadura izquierdo condensador 5µF FIR		
Para modelos:	GLB0040, GLB0041, GLB0042, GLB0044C		
repuestos para	500037		
	código	365017	referencia 206010
	 condensador de servicio capacidad 5µF 450V tolerancia 5% 50/60Hz temperatura ambiente máx. -25 a +85°C ø 28mm L 54mm M8 plástico empalme conector Faston 6,3mm 16.10.08 protección		
	código	510384	referencia —
	 cubierta de bomba entrada ø 28mm salida ø 26mm ø 100mm int. ø 76mm		

Continúa en la página siguiente

repuestos para	500037		
	código	510695	referencia —
sello mecánico altura contraarandela 5.5mm int.ø 11mm			
	código	521203	referencia —
rotor ø 72mm H 18mm rosca M7 árbol ø 11mm longitud árbol 32mm palas 3			
	código	521703	referencia —
junta de tapa de bomba EPDM espesor 2.5mm int.ø 75mm UE 1 pzs			



1	código	502287	referencia	77047
descripción bomba entrada ø 30mm salida ø 26mm tipo 5213.4050 230/400V 50Hz fases 3 0.11kW 0.15PS L 200mm dirección de rodadura izquierdo				
Para modelos: GLB0049, GLB0050, GLB0051				
repuestos para 502287				
	código	699372	referencia	80814
brida para bomba con cubierta tipo 5213 L 103mm An 103mm H 69mm				





1	código	499353	referencia	12024782
descripción bomba entrada ø 30mm salida ø 26mm tipo 5213E2451 230V 50Hz fases 1 0.22kW 0.1PS L 190mm dirección de rodadura izquierdo condensador 5µF FIR				
Para modelos: AIC0043-F, AIC0044-F, AIC0045-F, AIC0046-F				





1	código	499336	referencia	929175
descripción bomba entrada ø 62 salida ø 62 tipo 2250.2732 230/400V 50Hz 2.95kW 4PS				
Para modelos: GLB0044C				
repuestos para 499336				
	código	510687	referencia	929179
sello mecánico para árbol ø 18mm altura contraarandela 8mm int.ø 17mm ø ext. 39mm H 15mm montaje ø 42mm ø int. 1 21mm				
	código	521026	referencia	—
junta de tapa de bomba int.ø 182.5mm espesor 5x4,5mm				
	código	521028	referencia	—
cubierta de bomba FIR entrada ø 62mm salida ø 62mm sentido de rotación derecho ø 215mm int.ø 175mm altura interior 40mm				
	código	521277	referencia	929181
rotor ø 135mm H 39mm tipo bomba Fir 2275 - 3,7PS rosca M14I				



1	código	499334	referencia	929174
descripción bomba entrada ø 62mm salida ø 62mm tipo 2250.2731 230/400V 50Hz fases 1 3kW FIR				
Para modelos: GLB0043C, GLB0044C				
repuestos para 499334				
	código	510687	referencia	929179
sello mecánico para árbol ø 18mm altura contraarandela 8mm int.ø 17mm ø ext. 39mm H 15mm montaje ø 42mm ø int. 1 21mm				
	código	512455	referencia	929189
rodete ventilador ø 155mm H 18mm soporte de eje ø 18mm plástico palas 12				





Continúa en la página siguiente

repuestos para	499334		
	código	521026	referencia —
	junta de tapa de bomba int.ø 182.5mm espesor 5x4,5mm		
	código	521028	referencia —
	cubierta de bomba FIR entrada ø 62mm salida ø 62mm sentido de rotación derecho ø 215mm int.ø 175mm altura interior 40mm		
	código	521277	referencia 929181
	rotor ø 135mm H 39mm tipo bomba Fir 2275 - 3,7PS rosca M14I		



código	500117	referencia	926150
descripción	bomba entrada ø 63mm salida ø 47mm tipo 4225.22725 230/400V 50Hz fases 3 1.4kW 2PS L 280mm dirección de rodadura derecho FIR		
Para modelos:	GLB0049, GLB0050, GLB0051		
repuestos para	500117		
	código	510602	referencia 124002
	rotor ø 110mm H 34mm dirección de rodadura derecho rosca M8L árbol ø 28mm soporte ø 12.2mm palas 6		
	código	510693	referencia 141002
	sello mecánico para árbol ø 12mm anillo deslizante ø ext. 24mm anillo deslizante H 15.5mm anillo deslizante ø int. 11mm contraarandela montaje ø 24mm altura contraarandela 8mm contraarandela ø int. 13.5mm		
	código	521513	referencia 116002
	cubierta de bomba FIR entrada ø 63mm salida ø 47mm sentido de rotación derecho int.ø 150mm altura interior 32mm		
	código	524416	referencia —
	junta de tapa de bomba espesor 4x4mm UE 1 pzs		



código	500570	referencia	75175
descripción	bomba entrada ø 63mm salida ø 47mm tipo 422512725 230/400V 50Hz fases 3 1.1kW 1.5PS L 285mm dirección de rodadura derecho FIR		
Para modelos:	GLB0045, GLB0047, GLB0048		
repuestos para	500570		
	código	510693	referencia 141002
	sello mecánico para árbol ø 12mm anillo deslizante ø ext. 24mm anillo deslizante H 15.5mm anillo deslizante ø int. 11mm contraarandela montaje ø 24mm altura contraarandela 8mm contraarandela ø int. 13.5mm		
	código	521082	referencia 80881
	rotor ø 96mm H 32mm dirección de rodadura derecho rosca M8L		
	código	521513	referencia 116002
	cubierta de bomba FIR entrada ø 63mm salida ø 47mm sentido de rotación derecho int.ø 150mm altura interior 32mm		
	código	524416	referencia —
	junta de tapa de bomba espesor 4x4mm UE 1 pzs		



código	499283	referencia	75175HZ
descripción	bomba entrada ø 63mm salida ø 47mm tipo 422512760 230/400V 60Hz fases 3 1.1kW L 290mm dirección de rodadura derecho FIR		
Para modelos:	GLB0047		



1

código	501540	referencia	929123
descripción	bomba entrada \varnothing 63mm salida \varnothing 47mm tipo 422522726 230/400V 50Hz fases 3 1.4kW 2PS L 280mm dirección de rodadura derecho FIR		
Para modelos:	GLB0041		
repuestos para	501540		
	código	510602	referencia 124002
	rotor \varnothing 110mm H 34mm dirección de rodadura derecho rosca M8L árbol \varnothing 28mm soporte \varnothing 12.2mm palas 6		
	código	510693	referencia 141002
	sello mecánico para árbol \varnothing 12mm anillo deslizante \varnothing ext. 24mm anillo deslizante H 15.5mm anillo deslizante \varnothing int. 11mm contraarandela montaje \varnothing 24mm altura contraarandela 8mm contraarandela \varnothing int. 13.5mm		
	código	521513	referencia 116002
	cubierta de bomba FIR entrada \varnothing 63mm salida \varnothing 47mm sentido de rotación derecho int. \varnothing 150mm altura interior 32mm		
	código	524416	referencia —
	junta de tapa de bomba espesor 4x4mm UE 1 pzs		

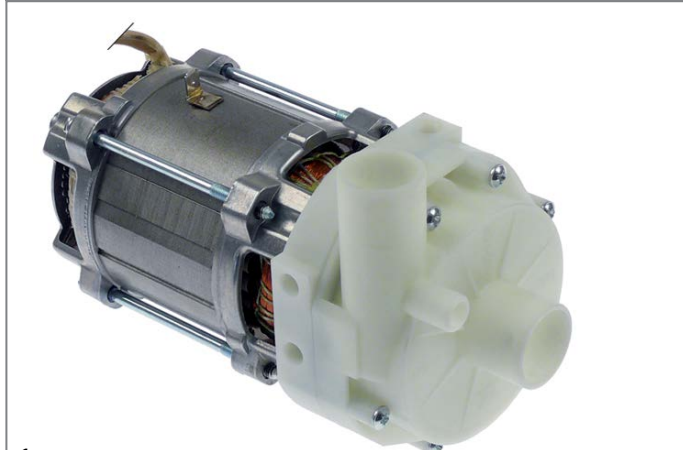

HANNING

bombas



1

código	499166	referencia	12024233
descripción	bomba entrada \varnothing 28mm salida \varnothing 26mm tipo UP60-414 220-240V 50/60Hz fases 1 0.25kW L 190mm dirección de rodadura derecho condensador 5 μ F HANNING p máx. 1bar Qmáx. 150l/min		
Para modelos:	GLB0067-F, GLB0069-F, GLB0071-F, GLB0080, GLB0081, GLB0082		
repuestos para	499166		
	código	365017	referencia 206010
	condensador de servicio capacidad 5 μ F 450V tolerancia 5% 50/60Hz temperatura ambiente máx. -25 a + 85°C \varnothing 28mm L 54mm M8 plástico empalme conector Faston 6,3mm 16.10.08 protección		

repuestos para	499166		
	código	507558	referencia —
	sello mecánico para árbol \varnothing 7mm altura contraarandela 5mm int. \varnothing 6.75mm \varnothing ext. 20mm montaje \varnothing contraarandela 18,5/arandela fricción 20mm		
	código	532644	referencia —
	junta tórica EPDM espesor 3mm int. \varnothing 78mm UE 1 pzs		

INSERT STAR

bombas





1

código	501562	referencia	12043287
descripción	bomba entrada \varnothing 38mm salida \varnothing 38mm tipo 2/123 FA-22 230V 50Hz fases 1 0.59kW 0.8PS dirección de rodadura derecho condensador 10 μ F INSERTSTAR		
Para modelos:	GLB0067-F, GLB0069-F, GLB0071-F, GLB0080, GLB0081		



LGB



1

código	501526	referencia	80629
descripción	bomba entrada \varnothing 28mm salida \varnothing 26mm tipo CRC-R DX 230V 60Hz fases 1 0.21kW L 175mm dirección de rodadura izquierdo condensador 4 μ F LGB		
Para modelos:	GLB0043C-60Hz		
repuestos para	501526		
	código	365031	referencia —
	condensador de servicio capacidad 4 μ F 450V tolerancia 5% 50/60Hz temperatura ambiente máx. -25 a + 85°C \varnothing 31mm L 58mm M8 plástico empalme conector Faston 6,3mm protección		
	código	509002	referencia —
	junta tórica EPDM espesor 2.62mm int. \varnothing 82.22mm UE 1 pzs		

Continúa en la página siguiente

repuestos para	501526			
	código	510703	referencia	—
	sello mecánico para árbol ø 13mm anillo deslizando H 13mm altura contraarandela 5.5mm ø ext. 26mm			
	código	521091	referencia	—
	cubierta de bomba LGB entrada ø 28mm salida ø 26mm tipo bomba CRC-R DX			
	código	521092	referencia	—
	rotor ø 80mm H 25mm tipo bomba CRC-R DX rosca M6R árbol ø 13mm longitud árbol 20mm			







1

código	499282	referencia	77553	
descripción	bomba entrada ø 60mm salida ø 49mm tipo ZF400VSX 220-230/380-400V 50Hz fases 3 0.7kW L 270mm dirección de rodadura derecho LGB			
Para modelos:	GLB0048, GLB0050, GLB0051			
repuestos para	499282			
	código	502279	referencia	—
	rotor H 31mm ø ext. 100mm palas 6			
	código	510702	referencia	—
	sello mecánico altura contraarandela 5.5mm int.ø 12mm			
	código	510709	referencia	926255
	sello mecánico			
	código	521058	referencia	—
	cubierta de rondete de ventilador apto para LGB int.ø 138mm ø ext. 142mm H 59mm plástico			
	código	521547	referencia	116013
	cubierta de bomba LGB entrada ø 60mm salida ø 50mm presión secundaria M8 sentido de rotación derecho ø 160mm int.ø 127mm altura interior 36mm			
	código	532623	referencia	—
	junta tórica EPDM espesor 2.62mm int.ø 120.32mm UE 1 pzs			



1

código	500360	referencia	80114	
descripción	bomba entrada ø 62mm salida ø 50mm tipo ZF522SX 230V 50Hz fases 1 1.1kW 1.5PS L 220mm dirección de rodadura derecho condensador 16µF LGB			
Para modelos:	GLB0040			
repuestos para	500360			
	código	365021	referencia	—
	condensador de servicio capacidad 16µF 425V tolerancia 5% 50/60Hz temperatura ambiente máx. -25 a + 85°C ø 35mm L 73mm simple M8 plástico empalme conector Faston 6,3mm 416.10.99 protección			
	código	510551	referencia	456023 926084
	junta de tapa de bomba int.ø 158.3mm tipo bomba 1214/1293/1225 /2243/1226/1204/3473/1241 espesor 3.53mm EPDM UE 1 pzs			
	código	510693	referencia	141002
	sello mecánico para árbol ø 12mm anillo deslizando ø ext. 24mm anillo deslizando H 15.5mm anillo deslizando ø int. 11mm contraarandela montaje ø 24mm altura contraarandela 8mm contraarandela ø int. 13.5mm			
	código	521280	referencia	—
	rotor ø 107mm H 26mm rosca M8L árbol ø 20mm longitud árbol 15mm soporte ø 8.2mm palas 6			
	código	521536	referencia	926086
	cubierta de bomba ALBA / LGB entrada ø 62mm salida ø 50mm presión secundaria 12mm presión secundaria cerrado sentido de rotación derecho ø 180mm int.ø 150mm altura interior 38mm			



bombas de aumento de presión I



1

código	500358	referencia	130120
descripción	bomba entrada \varnothing 3/8" salida \varnothing 3/8" tipo PS46 230V 50Hz 0.45kW \varnothing 100mm L 200mm condensador 10 μ F LGB		
Para modelos:	GLB0043C		
repuestos para	500358		
	código	510713	referencia —
		arandela fricción para árbol \varnothing 12mm \varnothing ext. 24mm H 16mm	
	código	510723	referencia —
		contraarandela H 8mm \varnothing ext. 26mm int. \varnothing 13.5mm per sello mecánico	
	código	698400	referencia —
		junta de tapa de bomba tipo bomba PS46 espesor 2mm int. \varnothing 66mm UE 1 pzs	
accesorios para	500358		
	código	365015	referencia 12024376 206002
		condensador de servicio capacidad 10 μ F 400V tolerancia 5%Hz temperatura ambiente máx. -25 a + 85°C \varnothing 35.5mm L 59mm M8 plástico empalme conector Faston 6,3mm protección	
	código	511279	referencia —
		empalme de tubo latón recto rosca 3/8" tubo \varnothing 12mm UE 1 pzs	
	código	520202	referencia 927015
		empalme de tubo latón niquelado recto rosca 3/8" tubo \varnothing 12mm UE 1 pzs	
	código	520677	referencia —
		empalme de tubo latón recto rosca 3/8" tubo \varnothing 13mm UE 1 pzs	



1

código	499073	referencia	12024708
descripción	bomba entrada \varnothing 31 salida \varnothing 27 tipo 887084885 230V 50Hz 0.75kW L 146mm condensador 2.5 μ F NIDEC		
Para modelos:	AIC0037-F, AIC0038-F, AIC0039-F, AIC0040-F, AIC0041-F, AIC0042-F		

bombas de salida

HANNING



1

código	501561	referencia	12094265
descripción	bomba de desagüe 38W 200-240V entrada \varnothing 30mm salida \varnothing 24mm 50/60Hz tipo DP25R-396 HANNING		
Para modelos:	GLB0069-F, GLB0081		



1

código	501595	referencia	12039546
descripción	bomba de desagüe 38W 200-240V entrada \varnothing 30mm salida \varnothing 24mm 50-60Hz tipo DPS25R-391 HANNING máx. 15min consumo de corriente 0.4A		
Para modelos:	AIC0037-F, AIC0038-F, AIC0039-F, AIC0040-F, AIC0041-F, AIC0042-F, AIC0043-F, AIC0044-F, AIC0045-F, AIC0046-F		



1

código	500363	referencia	80117
descripción	bomba de desagüe 40W 230V		
Para modelos:	GLB0040		



1

código	500737	referencia	12023456
descripción	bomba de desagüe 95W 230V entrada ø 24mm salida ø 24mm 50Hz tipo BE38B5-017 HANNING		
Para modelos:	GLB0071-F, GLB0080		

accesorios

cubiertas de bomba



1

código	521563	referencia	929191
descripción	cubierta de bomba		
Para modelos:	GLB0043C, GLB0043C-60Hz, GLB0044C		

bombas de aumento de presión II

accesorios



1

código	365015	referencia	12024376 206002
descripción	condensador de servicio capacidad 10µF 400V tolerancia 5%Hz temperatura ambiente máx. -25 a + 85°C ø 35.5mm L 59mm M8 plástico empalme conector Faston 6,3mm protección		
Para modelos:	GLB0043C, GLB0044C, GLB0067-F, GLB0069-F, GLB0071-F, GLB0080, GLB0081, GLB0082		

juntas para cubiertas de bomba



1

código	524535	referencia	929180
descripción	junta de tapa de bomba espesor 4,5x4,5mm int.ø 182mm UE 1 pzs		
Para modelos:	GLB0043C, GLB0043C-60Hz, GLB0044C		

condensadores y filtros antiparasitarios

condensadores de servicio

plástico



1

código	365017	referencia	206010
descripción	condensador de servicio capacidad 5µF 450V tolerancia 5% 50/60Hz temperatura ambiente máx. -25 a + 85°C ø 28mm L 54mm M8 plástico empalme conector Faston 6,3mm 16.10.08 protección		
Para modelos:	GLB0040, GLB0041, GLB0042		



1

código	365015	referencia	12024376 206002
descripción	condensador de servicio capacidad 10µF 400V tolerancia 5%Hz temperatura ambiente máx. -25 a + 85°C ø 35.5mm L 59mm M8 plástico empalme conector Faston 6,3mm protección		
Para modelos:	GLB0043C, GLB0044C, GLB0067-F, GLB0069-F, GLB0071-F, GLB0080, GLB0081, GLB0082		



1

código	365019	referencia	206005
descripción	condensador de servicio capacidad 20µF 400V tolerancia 5% 50/60Hz temperatura ambiente máx. -25 a + 85°C ø 39.5mm L 70mm M8 plástico empalme conector Faston 6,3mm 16.10.25. protección		
Para modelos:	GLB0040, GLB0047, GLB0048		



			
1			
código	365226	referencia	12025135
descripción	condensador de servicio capacidad 3µF 450V con revestimiento de plástico tolerancia 5% 50/60Hz ø 34mm L 64mm		
Para modelos:	AIC0037-F, AIC0038-F, AIC0039-F, AIC0040-F, AIC0041-F, AIC0042-F		

			
1			
código	365017	referencia	206010
descripción	condensador de servicio capacidad 5µF 450V tolerancia 5% 50/60Hz temperatura ambiente máx. -25 a + 85°C ø 28mm L 54mm M8 plástico empalme conector Faston 6,3mm 16.10.08 protección		
Para modelos:	GLB0040, GLB0041, GLB0042		

filtros

filtros antiparasitarios

			
1			
código	365221	referencia	661.120.00
descripción	filtro antiparasitario 250V 50/60Hz empalme 5 conector Faston 6,3mm M8 plástico capacidad 0,22µF(X2)+2x2mH+2X2,5nF(Y2)+1MOhmµF		
Para modelos:	VS7080PG50, VS7080PG150, VS9080PG1150		

fusibles

fusibles finos

			
1			
código	358530	referencia	926284
descripción	fusible fino medida ø5x20mm 0.8A rápido nominal 250V UE 10 pzs		
Para modelos:	GLB0040, GLB0041, GLB0042, GLB0043C, GLB0044C, GLB0045, GLB0047, GLB0048		

			
1			
código	358677	referencia	228004
descripción	fusible fino medida ø5x20mm 4A rápido nominal 250V UE 10 pzs		
Para modelos:	GLB0040, GLB0041, GLB0042, GLB0043C, GLB0043C-60Hz, GLB0044C, GLB0047, GLB0048		

			
1			
código	358594	referencia	228012
descripción	fusible fino medida ø5x20mm 0.16A retardado nominal 250V UE 10 pzs		
Para modelos:	GLB0043C-60Hz, GLB0047		

			
1			
código	358603	referencia	228011
descripción	fusible fino medida ø5x20mm 2A retardado nominal 250V UE 10 pzs		
Para modelos:	GLB0043C-60Hz, GLB0047		

			
1			
código	358760	referencia	926283
descripción	fusible fino medida ø6,3x32mm 0,315A semi retardado nominal 250V UE 10 pzs		
Para modelos:	GLB0040, GLB0041, GLB0042, GLB0043C, GLB0044C, GLB0045, GLB0047, GLB0048		

portafusibles

			
1			
código	550536	referencia	12025158
descripción	portafusibles fusible adaptable ø10x38mm 30A nominal 600V		
Para modelos:	AIC0037-F, AIC0038-F, AIC0039-F, AIC0040-F, AIC0041-F, AIC0042-F, AIC0043-F, AIC0045-F, AIC0071-F, AIC0072-F, AIC0073-F, AIC0074-F, AIC0075-F, AIC0076-F, AIC0077-F, AIC0078-F, AIC0079-F, AIC0080-F, GLB0071-F, GLB0080, GLB0082		



			
1			
código	550499	referencia	H.228047
descripción	portafusibles fusible adaptable ø5x20mm 6.3A nominal 500V		
Para modelos:	GLB0040, GLB0041, GLB0042, GLB0043C, GLB0044C, GLB0047, GLB0048, GLB0049		

			
1			
código	550519	referencia	H.228048
descripción	placa de cubierta fusible adaptableA nominalV empalme para portafusibles		
Para modelos:	GLB0040, GLB0041, GLB0042, GLB0043C, GLB0044C, GLB0047, GLB0048		

fusibles térmicos

			
1			
código	358193	referencia	663.078.00
descripción	fusible térmico temp. desconexión 110°C		
Para modelos:	VS7080TPET, VS7080TPFE		

			
1			
código	358190	referencia	663.077.00
descripción	fusible térmico temp. desconexión 98°C		
Para modelos:	VS9080TPET, VS9080TPFE		

accesorios eléctricos

cables

cables de alimentación aparatos

			
1			
código	551265	referencia	B00FK100
descripción	cable de alimentación CEE7/7 tipo E+F 3 polos contactos P+N+T 1.5mm ² máx. 16A máx. 230V 2m H05VVF aislam. PVC países D/F/B/I negro		
Para modelos:	BMA0008-F, BMA0010-F, BMA0021-F, BMA0022-F, BMA0024-F, BMA0025-F, BMA0026-F, BMA0027-F, BMA0028-F, BMA0029-F, BMA0032-F, BMA0035-F, BMA0036-F, BMB0028-F, BMB0029-F, BMB0030-F, BMB0033-F, BMB0034-F, BMB0035-F, BMB0036-F, BMB0037-F, BMC0012-F, BMC0014-F, BMC0015-F, BMC0016-F, BNA0030-F, BNA0031-F, BNA0036-F, BNA0037-F, BNA0044-F, BNA0045-F, BNA0052-F, BNA0053-F, BNA0054-F, BNA0055-F, BNA0056-F, BNA0057-F, BNA0064-F, BNA0065-F, BNA0066-F, BNB0010-F, BNB0011-F, BNB0012-F, BNB0013-F, BNB0014-F, BNB0015-F, BNZ0001-F, BNZ0002-F, BNZ0003-F, BNZ0004-F...(Otros modelos se puede ver en la tienda web)		

accesorios

pasacables

racores para cables

uniones roscadas

			
1			
código	550971	referencia	12009963
descripción	racor para cables rosca PG16 ø cable 14mm montaje ø 22.5mm UE 1 pzs plástico EC 27		
Para modelos:	AIC0037-F, AIC0071-F		

tuercas de fijación

			
1			
código	550974	referencia	12010063
descripción	tuerca rosca PG21 EC 34 plástico UE 1 pzs espesor 7.5mm montaje ømm ø cablemm		
Para modelos:	AIC0037-F, AIC0039-F, AIC0072-F		

cables de cinta plana

grupo 1

			
1			
código	402970	referencia	41523
descripción	cable de cinta plana 10 polos L 1200mm tipo de conector 2 filas codificado UE 1m		
Para modelos:	GLB0041, GLB0042, GLB0043C, GLB0044C, GLB0045, GLB0047, GLB0048		

			
1			
código	403250	referencia	926272
descripción	cable de cinta plana 10 polos L 3000mm tipo de conector cifrado 2 filas número de polos de conector 10		
Para modelos:	GLB0040		

			
1			
código	400902	referencia	80934
descripción	cable de cinta plana 10 polos L 750mm tipo de conector FC-10P medida reticular 2.54mm		
Para modelos:	GLB0043C-60Hz, GLB0047		



terminales

regletas de bornes a tornillo/con contactos de enchufe



1

código	505212	referencia	12024110
descripción	borne de conexión 2 polos máx. 20A máx. 600V empalme $\varnothing 2,5\text{mm}^2$ / F6,3 resis.a la temp. 150°C sección nominal 4mm ²		
Para modelos:	GLB0067-F, GLB0069-F, GLB0081		



1

código	550278	referencia	M566050000
descripción	borne de conexión 3 polos máx. 40A máx. 400V empalme $\varnothing 6\text{mm}^2$ / F6,3 resis.a la temp. 150°C sección nominal 6mm ²		
Para modelos:	VS7040BMET, VS7040BMFEP, VS7040CPES, VS7040FRG17VL, VS7040SPET, VS7080CPES, VS7080FRG17VL, VS9040BMET, VS9040BMFEP, VS9040CPES, VS9040FRG17VL, VS9040FRG21VL, VS9040SPET, VS9080CPES, VS9080FRG17VL, VS9080FRG21VL		



1

código	550411	referencia	12025183 220011 M566050500
descripción	borne de conexión 6 polos máx. 40A máx. 450V empalme $\varnothing 6\text{mm}^2$ / F6,3 resis.a la temp. 150°C sección nominal 6mm ²		
Para modelos:	GLB0040, GLB0041, GLB0042, GLB0043C, GLB0043C-60Hz, GLB0044C, GLB0067-F, GLB0069-F, GLB0081, V080FTREVCRT, V7040FTREVCRT, V9040FTREVCRT, V9080FTREVCRT, V9080FTRRECR, VS70120CFGE, VS7040FRE17X, VS7040FRE88, VS7040FTET, VS7040FTEVCRT, VS7040FTEVT, VS7040FTRET, VS7040FTREVT, VS7040GRACQE, VS7040PCEQT, VS7040PCET, VS7080BMET, VS7080BMFEP, VS7080CFE, VS7080CFEQ, VS7080CFGE, VS7080CFVE, VS7080FTET, VS7080FTEVCRT, VS7080FTEVT, VS7080FTRET, VS7080FTREVT, VS7080FTRRET, VS7080FTRREVC, VS7080FTRREVT, VS7080GRACQE, VS7080PCEQT, VS7080PCET, VS7080PVET, VS7080TPET, VS7080TPFE, VS90120CFGE, VS90160CFGE, VS9040FRE17, VS9040FRE21, VS9040FRE88...(Otros modelos se puede ver en la tienda web)		

regletas de bornes a tornillo



1

código	551402	referencia	463.026.00
descripción	borne de conexión 3 polos máx. 40A máx. 450V empalme M5 resis.a la temp. 150°C		
Para modelos:	VS7080BRGI, VS7080BRGIM, VS7080PG50, VS7080PGI50, VS9080BRGI, VS9080BRGIM, VS9080PGI150		



1

código	550507	referencia	663.036.00
descripción	borne de conexión 4 polos máx. 40A máx. 400V empalme M6/M6 resis.a la temp. 150°C		
Para modelos:	VS7040CPES, VS7080CPES		



1

código	550355	referencia	963.007.00
descripción	borne de conexión 6 polos máx. 40A máx. 400V empalme M6/M6 resis.a la temp. 150°C sección nominal 6mm ² dist. del agujero 122mm		
Para modelos:	VS7040FRE10, VS7080BREI, VS7080BREIM, VS7080CFVE, VS7080FRE10, VS7080PVET, VS9040FRE15, VS9040INDT, VS9040INDWT, VS9040PVET, VS9080BREI, VS9080BREIM, VS9080CFVE, VS9080FRE15, VS9080INDT, VS9080PVET		

bloques de bornes

SIEMENS

bornes de paso



1

código	551238	referencia	663.061.00
descripción	borne seccionable 16mm ² beige 1 polos		
Para modelos:	VS7040PCEQT, VS7040PCET, VS7080FRE17X, VS7080PCEQT, VS7080PCET, VS9040PCEST, VS9080FRE17, VS9080FRE21, VS9080PCEST		



1

código	551420	referencia	663.059.00
descripción	borne seccionable 16mm ² beige para grill		
Para modelos:	VS7040PCEQT, VS7040PCET, VS7080FRE17X, VS7080PCEQT, VS7080PCET, VS7080PEI50, VS9040PCEST, VS9080FRE17, VS9080FRE21, VS9080PCEST, VS9080PEI150		



1

código	551431	referencia	663.076.00
descripción	borne seccionable SIEMENS 16mm ² azul H 46mm An 41mm L 10mm		
Para modelos:	VS7040PCEQT, VS7040PCET, VS7080FRE17X, VS7080PCEQT, VS7080PCET, VS9040PCEST, VS9080FRE17, VS9080FRE21, VS9080PCEST		



1

código	551396	referencia	663.060.00
descripción	borne seccionable SIEMENS tipo 8WA1011-1PK00 16mm ² amarillo/verde para barra DIN 35mm H 40mm An 10mm L 53mm		
Para modelos:	VS7040PCEQT, VS7040PCET, VS7080FRE17X, VS7080PCEQT, VS7080PCET, VS9040PCEST, VS9080FRE17, VS9080FRE21, VS9080PCEST		

WEIDMÜLLER

bornes de paso



1

código	551230	referencia	12024942
descripción	borne seccionable 70mm ² para barra DIN 35mm gris 1 polos		
Para modelos:	AIC0045-F, AIC0075-F		

accesorios



1

código	550789	referencia	12024199
descripción	borne seccionable gris para barra DIN 35mm		
Para modelos:	AIC0038-F, AIC0040-F, AIC0042-F, AIC0044-F, AIC0046-F, AIC0076-F, AIC0077-F, AIC0078-F, AIC0079-F, AIC0080-F, GLB0071-F, GLB0080, GLB0082		

WIELAND

bloques de bornes tipo 9700A



1

código	550381	referencia	12023373
descripción	borne seccionable WIELAND tipo 9700A/8 S35 1,0-10mm ² riel de sombrero 35mm gris An 8mm L 46.6mm		
Para modelos:	AIC0037-F, AIC0071-F, GLB0071-F, GLB0080, GLB0082		

otros



1

código	550996	referencia	927115
descripción	borne seccionable 0,5-4mm ² verde/amarillo para TS 35 (plástico)		
Para modelos:	GLB0049		

accesorios en general

puntos de conexión



1

código	551457	referencia	663.056.00
descripción	puente de conexión para borne seccionable		
Para modelos:	VS7040PCEQT, VS7040PCET, VS7080FRE17X, VS7080PCEQT, VS7080PCET, VS9040PCEST, VS9080FRE17, VS9080FRE21, VS9080PCEST		

barras DIN



1

código	551018	referencia	12022528
descripción	carril DIN An 35mm L 72mm dist. del agujero 52mm		
Para modelos:	AIC0037-F, AIC0039-F, AIC0071-F, AIC0072-F		

grifos de gas

PEL

serie 21S



1

código	103342	referencia	671.090.00
descripción	brida PEL tipo 21S con tapón tubo ø 21mm		
Para modelos:	V70120TPPCFG2, V70120TPPCG2T, V90120TPPCFG2, V90120TPPCG2T, VS7080TPPCFG, VS7080TPPCGT, VS9080TPPCFG, VS9080TPPCGT		



1

código	109515	referencia	671.088.00
descripción	grifo de gas PEL tipo 21S entrada gas brida de tubo ø21mm boquilla bypass ø 0mm salida gas M16x1,5 (tubo ø 10/8mm) conexión termopar M8x1 conexión de piloto M10x1 eje ø 8x6,5mm eje L 22/15mm parte plana arriba		
Para modelos:	V70120TPPCFG2, V70120TPPCG2T, V7040FTRGVCRT, V7080FTRGVCRT, V90120TPPCFG2, V90120TPPCG2T, V9040FTRGVCRT, V9080FTRGVCRT, V9080FTRRGCR, VS70120CFG, VS70120CFGE, VS70120CFGG, VS70120PCGT, VS70120PPFG, VS7040CPGS, VS7040FTGT, VS7040FTGVCRT, VS7040FTGVT, VS7040FTRGT, VS7040FTRGVT, VS7040GRL, VS7040PCGT, VS7080CFG, VS7080CFGE, VS7080CPGS, VS7080FTGT, VS7080FTGVCRT, VS7080FTGVT, VS7080FTRGT, VS7080FTRGVT, VS7080FTRRGT, VS7080FTRRGVC, VS7080FTRRGVT, VS7080GRL, VS7080PCGT, VS7080TPPCFG, VS7080TPPCGT, VS90120CFG, VS90120CFGE, VS90120CFGG, VS90120PCGP, VS90120PCGT, VS90160CFG, VS90160CFGE, VS9040CPGS, VS9040FTGCR, VS9040FTGT, VS9040FTGVCRT, VS9040FTGVT, VS9040FTRGCR... (Otros modelos se puede ver en la tienda web)		
repuestos para	109515		
	código	101060	referencia —
	grupo magnético estándar L 39mm D1 ø 15.4mm D2 ø 11mm apto para PEL20-21/JUNKERS/EGA		
	código	101206	referencia —
	parte delantera de grifo de gas eje ø 8x6,5mm eje L 22/15mm parte plana arriba/abajo apto para PEL21		
	código	101230	referencia —
	tuerca de termopar G1: M8x1 G2: M18x1 aluminio		
accesorios para	109515		
	código	100908	referencia —
	tornillo de racor rosca M10x1 para tuboø 4mm UE 1 pzs		
	código	100909	referencia —
	tornillo de racor rosca M10x1 para tuboø 6mm UE 1 pzs		
	código	101246	referencia —
	anillo cortante para tuboø 4mm UE 1 pzs		

accesorios para	109515		
	código	101278	referencia —
	anillo cortante para tuboø 10mm UE 1 pzs		
	código	101286	referencia —
	anillo cortante int.ø 6mm UE 1 pzs		
	código	101300	referencia —
	tuerca de racor rosca M16x1,5 tubo ø 10mm		
	código	101450	referencia —
	anillo cortante para tuboø 8mm L 12.7mm UE 1 pzs ø ext. 10mm		
	código	101451	referencia —
	tuerca de racor rosca M16x1,5 tubo ø 8mm		
	código	110078	referencia —
	pomo sin símbolo ø 70mm eje ø 6x4,6mm parte plana universal		
	código	112206	referencia —
	símbolo para pomo plata grifo de gas PEL21/22/23 T máx°C ø ext. 63mm int.ø 45,5mm		

serie 22S/O



1

código	101086	referencia	671.031.00
descripción	grifo de gas PEL tipo 22S/O entrada gas M20x1,5 (tubo ø 12mm) boquilla bypass ø 0.35mm salida gas M20x1,5 (tubo ø 12/10mm) conexión termopar M9x1 conexión de piloto M10x1 eje ø 10x8mm eje L 25/17mm parte plana abajo		
Para modelos:	VS70120TPFG, VS7040GRACQG, VS7080GRACQG, VS7080TPFG, VS7080TPGT, VS90120TPFG, VS9040GRACQG, VS9080GRACQG, VS9080TPFG, VS9080TPGT		
repuestos para	101086		
	código	100259	referencia —
	boquilla bypass tipo PEL22 taladro ø 0.35mm rosca M6x0,5		
	código	101058	referencia —
	grupo magnético L 39mm D1 ø 15.4mm D2 ø 13.5mm apto para PEL22/EGA24197 estándar		
	código	101201	referencia —
	parte delantera de grifo de gas eje ø 10x8mm eje L 25/17mm parte plana arriba/abajo apto para PEL22		
	código	101231	referencia —
	tuerca de termopar G1: M9x1 G2: M18x1		
	código	101240	referencia —
	empalme de gas rosca M20x1.5 tubo ø 12/10mm para grifos de gas PEL con junta y tronillos horizontal		
	código	101460	referencia —
	junta tórica ø 12.37mm D1 ø 2.62mm apto para PEL22		
	código	101461	referencia —
	tornillo Kit apto para PEL22 UE 4 pzs		

Continúa en la página siguiente



accesorios para		101086		
imagen	código	referencia	—	
	100908	referencia	—	
tornillo de racor rosca M10x1 para tuboø 4mm UE 1 pzs				
	100909	referencia	—	
tornillo de racor rosca M10x1 para tuboø 6mm UE 1 pzs				
	101241	referencia	—	
empalme de gas rosca M20x1.5 tubo ø 12/10mm para grifos de gas PEL vertical				
	101246	referencia	—	
anillo cortante para tuboø 4mm UE 1 pzs				
	101248	referencia	—	
anillo cortante para tuboø 12mm UE 1 pzs apto para PEL				
	101249	referencia	—	
anillo cortante para tuboø 10mm UE 1 pzs				
	101250	referencia	—	
tuerca de racor rosca M20x1.5 para ø de tubo 10mm				
	101251	referencia	—	
tuerca de racor rosca M20x1.5 para ø de tubo 12mm				
	101286	referencia	—	
anillo cortante int.ø 6mm UE 1 pzs				
	110080	referencia	—	
pomo ø 70mm eje ø 10x8mm parte plana universal				
	112206	referencia	—	
símbolo para pomo plata grifo de gas PEL21/22/23 T máx°C ø ext. 63mm int.ø 45.5mm				

termostatos para gas

SIT

serie 630 Eurosit

1				
código	107688	referencia	256.277.00	
descripción	termostato de gas 100-340°C entrada gas 3/8" salida gas 3/8" conexión termopar M9x1 conexión de piloto M10x1 sonda ø 4mm sonda L 72mm capilar 1050mm			
Para modelos:	V70120TPPCFG2, V90120TPPCFG2, VS70120CFG, VS70120CFGG, VS70120TPFG, VS7080CFG, VS7080TPFG, VS7080TPPCFG, VS90120CFG, VS90120CFGG, VS90120TPFG, VS90160CFG, VS9080CFG, VS9080TPFG, VS9080TPPCFG			



1				
código	103076	referencia	256.408.00	
descripción	termostato de gas tipo serie 630 Eurosit T máx 190°C 110-190°C entrada gas 3/8" salida gas 3/8" conexión termopar M9x1 conexión de piloto M10x1 sonda ø 4mm sonda L 202mm capilar 1050mm SIT			
Para modelos:	VS7040FRGS13, VS7080FRGS13, VS9040FRGS13, VS9040FRGS20, VS9080FRGS13, VS9080FRGS20			

PEL

serie 25ST

1				
código	101441	referencia	971.000.00	
descripción	termostato de gas PEL tipo 25ST 30-90°C entrada gas M16x1,5 (tubo ø 10mm) boquilla bypass ø 0.35mm salida gas M16x1,5 (tubo ø 10/8mm) conexión termopar M9x1 conexión de piloto M10x1 capilar 1200mm sonda ø 6mm sonda L 160mm eje ø 8x6,5mm eje L 21/15mm parte plana arriba			
Para modelos:	VS7040BMGT, VS7080BMGT, VS9040BMGT, VS9080BMGT			
repuestos para	101441			
	código	100259	referencia	—
boquilla bypass tipo PEL22 taladro ø 0.35mm rosca M6x0,5				
	código	101060	referencia	—
grupo magnético estándar L 39mm D1 ø 15.4mm D2 ø 11mm apto para PEL20-21/JUNKERS/EGA				
	código	106200	referencia	—
tuerca rosca M9x1 apto para PEL24/25S				
accesorios para	101441			
	código	100908	referencia	—
tornillo de racor rosca M10x1 para tuboø 4mm UE 1 pzs				
	código	100909	referencia	—
tornillo de racor rosca M10x1 para tuboø 6mm UE 1 pzs				
	código	101246	referencia	—
anillo cortante para tuboø 4mm UE 1 pzs				
	código	101278	referencia	—
anillo cortante para tuboø 10mm UE 1 pzs				
	código	101286	referencia	—
anillo cortante int.ø 6mm UE 1 pzs				
	código	101300	referencia	—
tuerca de racor rosca M16x1,5 tubo ø 10mm				

Continúa en la página siguiente

accesorios para	101441			
	código	101450	referencia	—
	anillo cortante para tuboø 8mm L 12.7mm UE 1 pzs ø ext. 10mm			
	código	101451	referencia	—
	tuerca de racor rosca M16x1,5 tubo ø 8mm			

válvulas de gas y centralitas de gas automáticas

válvulas de control de gas





SIT

NOVASIT



1

código	101908	referencia	256.331.00 256.335.00	
descripción	válvula de gas SIT serie Novasit 820 aliment. 230V 50Hz entrada gas 1/2" salida gas 1/2" conexión termopar M9x1 conexión de piloto M10x1 presión de encendidobar conexión del presostato ciego núm. Ref. 0.820.018 salida quemador de encendido M10x1 presión entrada máx. 60bar margen de ajuste 3-30bar			
Para modelos:	VS7040FRG17VL, VS7080BRGI, VS7080BRGIM, VS7080FRG17VL, VS7080PG50, VS7080PGI50, VS9040FRG17VL, VS9040FRG21VL, VS9080BRGI, VS9080BRGIM, VS9080FRG17VL, VS9080FRG21VL, VS9080PGI150			
repuestos para	101908			
	código	101065	referencia	—
	grupo magnético con cable L 44mm D1 ø 30mm D2 ø 20mm apto para NOVASIT			
	código	101313	referencia	—
	bobina magnética 230V 50Hz			
accesorios para	101908			
	código	100006	referencia	—
	encendedor piezoeléctrico apto para ELETTROSIT cuerpo plástico soplado empalme ø2,4mm ø 14mm			
	código	101305	referencia	—
	empalme de gas recto 1/2" brida 45x45mm ELETTROSIT/V4400/4600/4605 para SIT/HONEYWELL dist. del agujero 36x36mm			
	código	101306	referencia	—
	empalme de gas acodado brida 45x45mm dist. del agujero 36x36mm 1/2" ELETTROSIT/V4400/4600/4605 atornillado con junta tórica para SIT/HONEYWELL			
	código	101307	referencia	—
	empalme de gas recto brida 45x45mm dist. del agujero 36x36mm 3/4" ELETTROSIT/V4400/4600/4605 atornillado con junta tórica para SIT/HONEYWELL			
	código	101308	referencia	—
	empalme de gas acodado brida 45x45mm dist. del agujero 36x36mm 3/4" ELETTROSIT/V4400/4600/4605 atornillado con junta tórica para SIT/HONEYWELL			

accesorios para	101908			
	código	101312	referencia	968.501.00
	microinterruptor			
	código	101314	referencia	—
	bobina magnética 24V 50Hz			
	código	101317	referencia	—
	conector con cable L 1000mm apto para NOVASIT			
	código	101318	referencia	—
	tapa para solenoide apto para NOVASIT			

accesorios



1

código	101312	referencia	968.501.00
descripción	microinterruptor		
Para modelos:	VS7040FRG17VL, VS7080BRGI, VS7080BRGIM, VS7080FRG17VL, VS7080PG50, VS7080PGI50, VS9040FRG17VL, VS9040FRG21VL, VS9080BRGI, VS9080BRGIM, VS9080FRG17VL, VS9080FRG21VL, VS9080PGI150		

SIGMA



1

código	107926	referencia	12046364
descripción	válvula de gas tipo 0848160 aliment. 230V 50Hz entrada gas 3/4" salida gas 3/4" margen de presión 0,5-12mbar SIT núm. Ref. 0848160		
Para modelos:	AIC0038-F, AIC0040-F, AIC0042-F, AIC0044-F, AIC0046-F, AIC0076-F, AIC0077-F, AIC0078-F, AIC0079-F, AIC0080-F		



encendidos y tempares

pilotos de encendido

SIT

serie 100



1

código	106901	referencia	672.080.00
descripción	piloto de encendido SIT tipo serie 100 1 llama boquilla ø 0.2mm empalme de gas 6mm		
Para modelos:	V70120TPPCFG2, V70120TPPCG2T, V90120TPPCFG2, V90120TPPCG2T, VS70120CFG, VS70120CFGE, VS70120CFGG, VS70120PCGT, VS70120TPFG, VS7040PCGT, VS7080CFG, VS7080CFGE, VS7080PCGT, VS7080TPPCFG, VS7080TPPCGT, VS90120CFG, VS90120CFGE, VS90120CFGG, VS90120PCGP, VS90120PCGT, VS90160CFG, VS90160CFGE, VS9040PCGP, VS9040PCGT, VS9080CFG, VS9080CFGE, VS9080PCGP, VS9080PCGT, VS9080TPPCFG, VS9080TPPCGT		
repuestos para	106901		
	código	100854	referencia —
	portapilotos doble		
	código	100916	referencia —
	resorte de compresión para quemador piloto UE 1 pzs		
	código	100917	referencia —
	junta para quemador piloto UE 1 pzs aluminio		
	código	100918	referencia —
	tornillo para quemador piloto		
accesorios para	106901		
	código	100904	referencia —
	tornillo de apriete M10x1 para tuboø 4mm UE 1 pzs		
	código	100905	referencia —
	tornillo de apriete M10x1 para tuboø 6mm UE 1 pzs		
	código	102110	referencia —
	tubo piloto cobre diámetro ø 4mm grosor de la pared 1mm L 3000mm		
	código	102111	referencia —
	tubo piloto cobre diámetro ø 6mm grosor de la pared 1mm L 3000mm		
	código	102742	referencia —
	boquilla de quemador piloto gas licuado código 25 taladro ø 0.25mm UE 1 pzs		



1

código	103344	referencia	672.184.00
descripción	piloto de encendido SIT tipo serie 100 3 llamas boquilla ø 0.35mm empalme de gas 4mm		
Para modelos:	VS7040FRGS13, VS7080FRGS13, VS9040FRGS13, VS9040FRGS20, VS9080FRGS13, VS9080FRGS20		
repuestos para	103344		
	código	100246	referencia —
	boquilla de quemador piloto gas natural taladro ø 0.35mm UE 1 pzs rosca M8x0,75		
	código	100855	referencia —
	portapilotos triple		
	código	100883	referencia —
	parte inferior de quemador piloto PRO-GAS serie 100 boquilla ø 0.35mm		
	código	100885	referencia —
	casquillo de mezcla de aire para quemador piloto UE 1 pzs		
	código	100904	referencia —
	tornillo de apriete M10x1 para tuboø 4mm UE 1 pzs		
	código	102664	referencia —
	parte superior de quemador piloto 3 llamas apto para serie 100 H 29mm L 40mm		



1





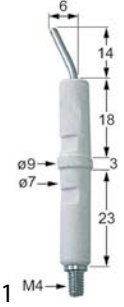

código	106907	referencia	672.057.00
descripción	piloto de encendido SIT tipo serie 100 3 llamas boquilla ø 0.35mm empalme de gas 6mm		
Para modelos:	VS70120TPFG, VS7040GRACQG, VS7080GRACQG, VS7080TPFG, VS7080TPGT, VS90120TPFG, VS9040GRACQG, VS9080GRACQG, VS9080TPFG, VS9080TPGT		
repuestos para	106907		
	código	100246	referencia —
	boquilla de quemador piloto gas natural taladro ø 0.35mm UE 1 pzs rosca M8x0,75		
	código	100855	referencia —
	portapilotos triple		
	código	100885	referencia —
	casquillo de mezcla de aire para quemador piloto UE 1 pzs		
	código	100916	referencia —
	resorte de compresión para quemador piloto UE 1 pzs		
	código	100917	referencia —
	junta para quemador piloto UE 1 pzs aluminio		

Continúa en la página siguiente

repuestos para 106907			
	código	100918	referencia —
tornillo para quemador piloto			
	código	107162	referencia —
parte superior de quemador piloto SIT 3 llamas Hmm Lmm UE 1 pzs			
	código	107702	referencia —
parte inferior de quemador piloto SIT serie 100 boquilla ø 0.35mm			
accesorios para 106907			
	código	100245	referencia —
boquilla de quemador piloto gas licuado código 20 taladro ø 0.2mm UE 1 pzs rosca M8x0,75			
	código	100904	referencia —
tornillo de apriete M10x1 para tubo ø 4mm UE 1 pzs			
	código	100905	referencia —
tornillo de apriete M10x1 para tubo ø 6mm UE 1 pzs			
	código	102110	referencia —
tubo piloto cobre diámetro ø 4mm grosor de la pared 1mm L 3000mm			
	código	102111	referencia —
tubo piloto cobre diámetro ø 6mm grosor de la pared 1mm L 3000mm			
	código	107171	referencia —
boquilla de quemador piloto SIT gas natural/licuado taladro ø 0.25mm UE 1 pzs			
	código	107700	referencia —
parte inferior de quemador piloto SIT serie 100 boquilla ø 0.25mm			
	código	107701	referencia —
parte inferior de quemador piloto SIT serie 100 boquilla ø 0.2mm			



			
código	107881	referencia	672.172.00
descripción	pilotaje de encendido SIT tipo serie 100 3 llamas boquilla ø 0.35mm empalme de gas 6mm con bujía		
Para modelos:	VS7040FRG17VL, VS7080FRG17VL, VS9040FRG17VL, VS9040FRG21VL, VS9080FRG17VL, VS9080FRG21VL		

accesorios			
electrodos de encendido			
			
código	100706	referencia	672.060.00
descripción	electrodo de encendido empalme M4 UE 1 pzs		
Para modelos:	VS70120TPFG, VS7040FRG17VL, VS7040FRGS13, VS7040GRACQG, VS7080FRG17VL, VS7080FRGS13, VS7080GRACQG, VS7080TPFG, VS7080TPGT, VS90120TPFG, VS9040FRG17VL, VS9040FRG21VL, VS9040FRGS13, VS9040FRGS20, VS9040GRACQG, VS9080FRG17VL, VS9080FRG21VL, VS9080FRGS13, VS9080FRGS20, VS9080GRACQG, VS9080TPFG, VS9080TPGT		

serie 140 - 145 -150			
			
código	107836	referencia	672.173.00
descripción	pilotaje de encendido SIT tipo serie 140 2 llamas boquilla ø 0,40/0,38mm completo		
Para modelos:	V70120TPPCFG2, V70120TPPCG2T, V7040FTRGVCRT, V7080FTRGVCRT, V90120TPPCFG2, V90120TPPCG2T, V9040FTRGVCRT, V9080FTRGVCRT, V9080FTRRGCR, VS7040BMGT, VS7040FTGT, VS7040FTGVCRT, VS7040FTGVT, VS7040FTRGT, VS7040FTRGVT, VS7080BMGT, VS7080BRGI, VS7080BRGIM, VS7080FTGT, VS7080FTGVCRT, VS7080FTGVT, VS7080FTRGT, VS7080FTRGVT, VS7080FTRRG, VS7080FTRRGVC, VS7080FTRRGVT, VS7080TPPCFG, VS7080TPPCGT, VS9040BMGT, VS9040FTGVCRT, VS9040FTGT, VS9040FTGVCRT, VS9040FTGVT, VS9040FTRGCR, VS9040FTRGT, VS9040FTRGVT, VS9080BMGT, VS9080BRGI, VS9080BRGIM, VS9080FTGCR, VS9080FTGT, VS9080FTGVCRT, VS9080FTGVT, VS9080FTRGT, VS9080FTRGVT, VS9080FTRRG, VS9080FTRRGVC, VS9080FTRRGVT, VS9080TPPCFG... (Otros modelos se puede ver en la tienda web)		
repuestos para 107836			
	código	100207	referencia —
boquilla de quemador piloto SIT gas natural código 27 taladro ø 0,40/0,38mm apto para SIT serie 140			
	código	100701	referencia 256.017.00 256.060.00
electrodo de encendido empalme M4 UE 1 pzs			
	código	100897	referencia —
anillo cortante para tubo ø 4mm UE 1 pzs para quemador piloto			
	código	100906	referencia —
unión roscada rosca M10x1 para electrodo de encendido latón UE 1 pzs EC 10			
	código	100909	referencia —
tornillo de racor rosca M10x1 para tubo ø 6mm UE 1 pzs			
accesorios para 107836			
	código	100801	referencia —
junta para quemador piloto UE 1 pzs			



Continúa en la página siguiente



accesorios para	107836			
	código	102110	referencia	—
	tubo piloto cobre diámetro ø 4mm grosor de la pared 1mm L 3000mm			
	código	102111	referencia	—
	tubo piloto cobre diámetro ø 6mm grosor de la pared 1mm L 3000mm			



código	103357	referencia	256.059.00
descripción	piloto de encendido SIT tipo serie 140 2 llamas gas natural/licuado		
Para modelos:	VS70120CFGG, VS7040CPGS, VS7040GRL, VS7080CPGS, VS7080GRL, VS90120CFGG, VS9040CPGS, VS9040GRL, VS9080CPGS, VS9080GRL		

repuestos para	103357			
	código	100205	referencia	—
	boquilla de quemador piloto SIT gas licuado código 19 taladro ø 0,23/0,26mm UE 1 pzs apto para SIT serie 150			
	código	100207	referencia	—
	boquilla de quemador piloto SIT gas natural código 27 taladro ø 0,40/0,38mm apto para SIT serie 140			
	código	100897	referencia	—
	anillo cortante para tuboø 4mm UE 1 pzs para quemador piloto			
	código	100906	referencia	—
	unión roscada rosca M10x1 para electrodo de encendido latón UE 1 pzs EC 10			
	código	100908	referencia	—
	tornillo de racor rosca M10x1 para tuboø 4mm UE 1 pzs			
	código	107114	referencia	—
	piloto de encendido SIT tipo serie 140 2 llamas boquilla ømm empalme de gasmm			

accesorios para	103357			
	código	100204	referencia	—
	boquilla de quemador piloto SIT gas licuado código 14 taladro ø 0,18/0,20mm UE 1 pzs apto para serie 140			
	código	100216	referencia	—
	boquilla de quemador piloto SIT gas natural código 38 taladro ø 0,45mm UE 1 pzs apto para SIT serie 150			
	código	100701	referencia	256.017.00 256.060.00
	electrodo de encendido empalme M4 UE 1 pzs			
	código	100801	referencia	—
	junta para quemador piloto UE 1 pzs			
	código	100898	referencia	—
	anillo cortante para tuboø 6mm UE 1 pzs para quemador piloto			
	código	100909	referencia	—
	tornillo de racor rosca M10x1 para tuboø 6mm UE 1 pzs			
	código	102110	referencia	—
	tubo piloto cobre diámetro ø 4mm grosor de la pared 1mm L 3000mm			
	código	102111	referencia	—
	tubo piloto cobre diámetro ø 6mm grosor de la pared 1mm L 3000mm			

serie 160















1

código	100056	referencia	672.042.00
---------------	--------	-------------------	------------

descripción	piloto de encendido SIT tipo serie 160 3 llamas boquilla ømm empalme de gasmm		
Para modelos:	V70120TPPCFG2, V90120TPPCFG2, VS70120CFG, VS70120TPFG, VS7080CFG, VS7080PG50, VS7080PGI50, VS7080TPFG, VS7080TPPCFG, VS90120CFG, VS90120TPFG, VS90160CFG, VS9080CFG, VS9080PGI150, VS9080TPFG, VS9080TPPCFG		

repuestos para	100056			
	código	100907	referencia	—
	unión roscada rosca M10x1 UE 1 pzs tipo SEF 1 ømm para termopar			

accesorios para	100056		
------------------------	--------	--	--

	código	100202	referencia	—
	boquilla de quemador piloto gas natural código 41 UE 1 pzs boquilla ø 0.41mm			
	código	100203	referencia	—
	boquilla de quemador piloto gas licuado código 25 UE 1 pzs boquilla ø 0.25mm			
	código	100701	referencia	256.017.00 256.060.00
	electrodo de encendido empalme M4 UE 1 pzs			
	código	100801	referencia	—
	junta para quemador piloto UE 1 pzs			
	código	100869	referencia	—
	boquilla de quemador piloto gas natural código 51 UE 1 pzs apto para serie 160 boquilla ø 0.51mm			
	código	100870	referencia	—
	anillo cortante para tuboø 4mm UE 1 pzs apto para serie 160 para quemador piloto			
	código	100906	referencia	—
	unión roscada rosca M10x1 para electrodo de encendido latón UE 1 pzs EC 10			
	código	100908	referencia	—
	tornillo de racor rosca M10x1 para tuboø 4mm UE 1 pzs			
	código	100909	referencia	—
	tornillo de racor rosca M10x1 para tuboø 6mm UE 1 pzs			
	código	101287	referencia	—
	anillo cortante para tuboø 6mm UE 1 pzs			
	código	102110	referencia	—
	tubo piloto cobre diámetro ø 4mm grosor de la pared 1mm L 3000mm			
	código	102111	referencia	—
	tubo piloto cobre diámetro ø 6mm grosor de la pared 1mm L 3000mm			
	código	107650	referencia	—
	boquilla de quemador piloto SIT gas licuado código 30 UE 1 pzs			

electródos

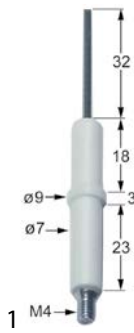

código	100701	referencia	256.017.00 256.060.00
descripción	electrodo de encendido empalme M4 UE 1 pzs		
Para modelos:	V70120TPPCFG2, V70120TPPCG2T, V7040FTRGVCRT, V7080FTRGVCRT, V90120TPPCFG2, V90120TPPCG2T, V9040FTRGVCRT, V9080FTRGVCRT, V9080FTRRGCR, VS70120CFG, VS70120CFGG, VS70120TPFG, VS7040BMGT, VS7040CPGS, VS7040FTGT, VS7040FTGVCRT, VS7040FTGVT, VS7040FTRGT, VS7040FTRGVT, VS7040GRL, VS7080BMGT, VS7080BRGI, VS7080BRGIM, VS7080CFG, VS7080CPGS, VS7080FTGT, VS7080FTGVCRT, VS7080FTGVT, VS7080FTRGT, VS7080FTRGVT, VS7080FTRRG, VS7080FTRRGV, VS7080FTRRGVT, VS7080GRL, VS7080PG50, VS7080PGI50, VS7080TPFG, VS7080TPPCFG, VS7080TPPCGT, VS90120CFG, VS90120CFGG, VS90120TPFG, VS90160CFG, VS9040BMGT, VS9040CPGS, VS9040FTGVCRT, VS9040FTGT, VS9040FTGVCRT, VS9040FTGVT, VS9040FTRGCR... (Otros modelos se puede ver en la tienda web)		

accesorios para	100701	código	100906	referencia	—
	unión roscada rosca M10x1 para electrodo de encendido latón UE 1 pzs EC 10				



código	100706	referencia	672.060.00
descripción	electrodo de encendido empalme M4 UE 1 pzs		
Para modelos:	VS70120TPFG, VS7040FRG17VL, VS7040FRGS13, VS7040GRACQG, VS7080FRG17VL, VS7080FRGS13, VS7080GRACQG, VS7080TPFG, VS7080TPGT, VS90120TPFG, VS9040FRG17VL, VS9040FRG21VL, VS9040FRGS13, VS9040FRGS20, VS9040GRACQG, VS9080FRG17VL, VS9080FRG21VL, VS9080FRGS13, VS9080FRGS20, VS9080GRACQG, VS9080TPFG, VS9080TPGT		



código	104806	referencia	12039586
descripción	electrodo de encendido longitud brida 23mm anchura brida 16mm D1 ø 9.4mm D2 ø 9.4mm L1 25mm LC1 17mm LC2 36mm		
Para modelos:	AIC0038-F, AIC0040-F		



código	104803	referencia	12039448
descripción	electrodo de encendido longitud brida 23mm anchura brida 16mm D1 ø 9.5mm D2 ø 9.5mm L1 10mm L2 79mm LC1 72.5mm LC2 24mm brida		
Para modelos:	AIC0042-F, AIC0046-F, AIC0078-F, AIC0080-F		



código	104804	referencia	12039685
descripción	electrodo de encendido longitud brida 23mm anchura brida 16mm D1 ø 9mm D2 ø 9mm L1 17mm L2 79mm LC1 80mm LC2 17mm empalme M4 brida		
Para modelos:	AIC0038-F, AIC0040-F, AIC0044-F, AIC0076-F, AIC0077-F, AIC0079-F		



código	104802	referencia	12039447
descripción	electrodo de encendido longitud brida 28mm anchura brida 16mm D1 ø 9.4mm D2 ø 9.4mm L1 9mm L2 73mm LC1 72.5mm LC2 26mm empalme F2,8 longitud del cable 260mm distancia de sujeción 20mm brida		
Para modelos:	AIC0042-F, AIC0046-F, AIC0078-F, AIC0080-F		



código	104805	referencia	12039684
descripción	electrodo de encendido longitud brida 28mm anchura brida 16mm D1 ø 9mm D2 ø 9mm L1 16.5mm L2 80mm LC1 81mm LC2 16.5mm empalme F2,8 longitud del cable 250mm distancia de sujeción 20mm brida		
Para modelos:	AIC0038-F, AIC0040-F, AIC0044-F, AIC0076-F, AIC0077-F, AIC0079-F		

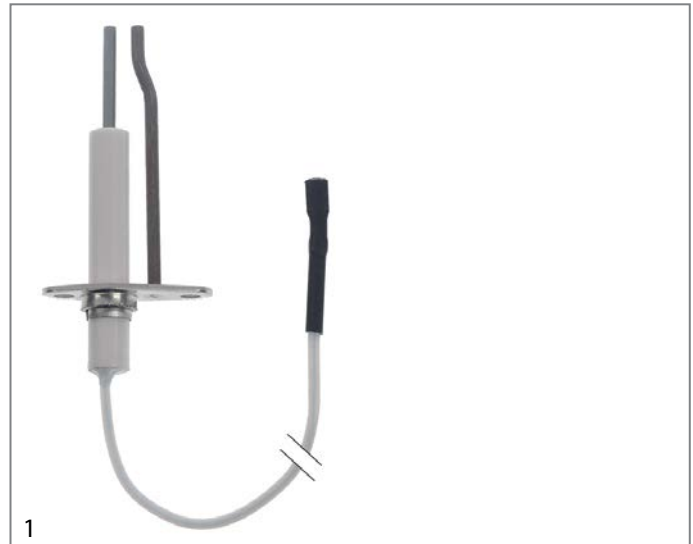

código	104807	referencia	12039585
descripción	electrodo de encendido longitud brida 38mm anchura brida 16mm D1 ø 9.4mm D2 ø 9.4mm L1 25mm LC1 17mm LC2 36mm empalme F2,8 longitud del cable 250mm medida de sujeción 4mm distancia de sujeción 28mm brida		
Para modelos:	AIC0038-F, AIC0040-F		

encendedores piezoeléctricos

diámetro de montaje 22mm



código	103341	referencia	912.091.00
descripción	encendedor piezoeléctrico cuerpo plástico soplado montaje ø 22mm empalme ø2,4mm		
Para modelos:	V70120TPPCFG2, V70120TPPCG2T, V7040FTRGVCRT, V7080FTRGVCRT, V90120TPPCFG2, V90120TPPCG2T, V9040FTRGVCRT, V9080FTRGVCRT, V9080FTRRGCR, VS70120CFG, VS70120CFGG, VS70120TPFG, VS7040BMGT, VS7040CPGS, VS7040FRGS13, VS7040FTGT, VS7040FTGVCRT, VS7040FTGVT, VS7040FTRGT, VS7040FTRGVT, VS7040GRACQG, VS7040GRL, VS7080BMGT, VS7080CFG, VS7080CPGS, VS7080FRGS13, VS7080FTGT, VS7080FTGVCRT, VS7080FTGVT, VS7080FTRGT, VS7080FTRGVT, VS7080FTRRG, VS7080FTRRGVC, VS7080FTRRGVT, VS7080GRACQG, VS7080GRL, VS7080TPFG, VS7080TPGT, VS7080TPPCFG, VS7080TPPCG, VS90120CFG, VS90120CFGG, VS90120TPFG, VS90160CFG, VS9040BMGT, VS9040CPGS, VS9040FRGS13, VS9040FRGS20, VS9040FTGVCRT, VS9040FTGT...(Otros modelos se puede ver en la tienda web)		

repuestos para	103341
-----------------------	--------

	código	100013	referencia	—
	descripción	encendedor piezoeléctrico cuerpo plástico soplado montaje ø 22mm empalme ø2,4mm longitud del cable mm		

	código	101339	referencia	951.047.00
	descripción	tapa para piezoencendedor		

accesorios



código	101339	referencia	951.047.00
descripción	tapa para piezoencendedor		
Para modelos:	V70120TPPCFG2, V70120TPPCG2T, V7040FTRGVCRT, V7080FTRGVCRT, V90120TPPCFG2, V90120TPPCG2T, V9040FTRGVCRT, V9080FTRGVCRT, V9080FTRRGCR, VS70120CFG, VS70120CFGG, VS70120TPFG, VS7040BMGT, VS7040CPGS, VS7040FRGS13, VS7040FTGT, VS7040FTGVCRT, VS7040FTGVT, VS7040FTRGT, VS7040FTRGVT, VS7040GRACQG, VS7040GRL, VS7080BMGT, VS7080CFG, VS7080CPGS, VS7080FRGS13, VS7080FTGT, VS7080FTGVCRT, VS7080FTGVT, VS7080FTRGT, VS7080FTRGVT, VS7080FTRRG, VS7080FTRRGVC, VS7080FTRRGVT, VS7080GRACQG, VS7080GRL, VS7080TPFG, VS7080TPGT, VS7080TPPCFG, VS7080TPPCGT, VS90120CFG, VS90120CFGG, VS90120TPFG, VS90160CFG, VS9040BMGT, VS9040CPGS, VS9040FRGS13, VS9040FRGS20, VS9040FTGCRT, VS9040FTGT...(Otros modelos se puede ver en la tienda web)		

unidades de encendido

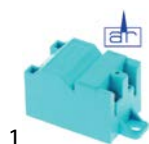

código	101012	referencia	961.030.00
descripción	grupo de encendido salidas 2 230VAC medidas 48x32x32mm distancia de sujeción 56mm entrada F2,8x0,8 salida F2,8x0,8 tipo ZIG2 50-60Hz		
Para modelos:	VS7080BRGI, VS7080BRGIM, VS7080PG50, VS7080PGI50, VS9080BRGI, VS9080BRGIM, VS9080PGI150		



código	101002	referencia	661.118.00
descripción	grupo de encendido salidas 2 230VAC medidas 88x23x34mm distancia de sujeción 73mm entrada F6,3x0,8 salida F2,8x0,8 0.6VA 50/60Hz		
Para modelos:	VS7040FRG17VL, VS7080FRG17VL, VS9040FRG17VL, VS9040FRG21VL, VS9080FRG17VL, VS9080FRG21VL		

interruptores de encendido



código	348219	referencia	961.048.00
descripción	pulsador montaje ø 25mm negro 1NO 250V 16A empalme conector Faston 6,3mm temperatura ambiente máx. 120°C		
Para modelos:	VS7080BREI, VS7080BREIM, VS7080BRGI, VS7080BRGIM, VS9080BREI, VS9080BREIM, VS9080BRGI, VS9080BRGIM		

termopares

termopares insertables

termopares insertables estándar

con casquillo de enchufe ø6(6,5)mm

termopares SIT

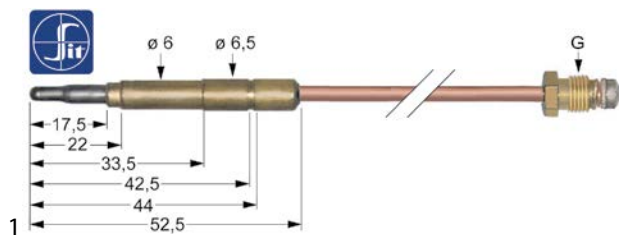

código	107613	referencia	672.154.00
descripción	termopar SIT M9x1 L 1200mm conexión para conector ø6,0(6,5)mm		
Para modelos:	V70120TPPCFG2, V90120TPPCFG2, VS70120CFG, VS7080CFG, VS7080TPPCFG, VS90120CFG, VS90160CFG, VS9080CFG, VS9080TPPCFG		

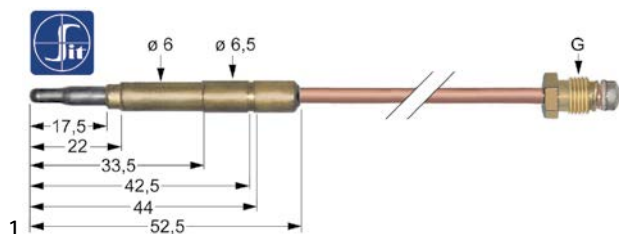

código	107614	referencia	672.104.00 672.179.00
descripción	termopar SIT M9x1 L 1500mm conexión para conector ø6,0(6,5)mm		
Para modelos:	VS70120CFGG, VS70120TPFG, VS7080TPFG, VS90120CFGG, VS90120TPFG, VS9080TPFG		

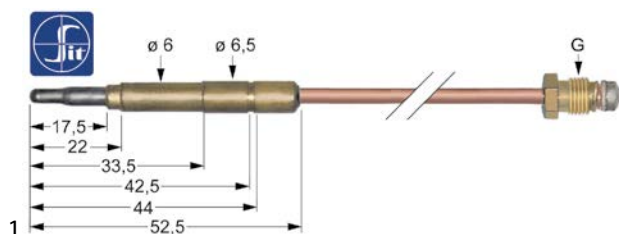

código	107608	referencia	672.001.00 672.025.00
descripción	termopar SIT M9x1 L 500mm conexión para conector ø6,0(6,5)mm		
Para modelos:	V70120TPPCFG2, V70120TPPCG2T, V90120TPPCFG2, V90120TPPCG2T, VS70120CFG, VS70120CFGE, VS70120CFGG, VS70120PCGT, VS70120TPFG, VS7040CPGS, VS7040GRL, VS7040PCGT, VS7080CFG, VS7080CFGE, VS7080CPGS, VS7080GRL, VS7080PCGT, VS7080PG50, VS7080PGI50, VS7080TPFG, VS7080TPGT, VS7080TPPCFG, VS7080TPPCGT, VS90120CFG, VS90120CFGE, VS90120CFGG, VS90120PCGP, VS90120PCGT, VS90120TPFG, VS90160CFG, VS90160CFGE, VS9040GRL, VS9040PCGP, VS9040PCGT, VS9080CFG, VS9080CFGE, VS9080GRL, VS9080PCGP, VS9080PCGT, VS9080PGI150, VS9080TPFG, VS9080TPGT, VS9080TPPCFG, VS9080TPPCGT		

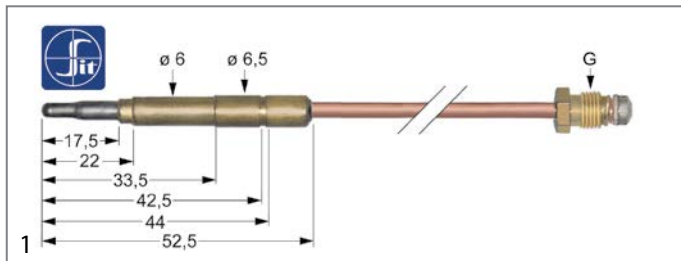

código	107611	referencia	672.083.00 672.099.00
descripción	termopar SIT M9x1 L 850mm conexión para conector ø6,0(6,5)mm		
Para modelos:	V70120TPPCFG2, V70120TPPCG2T, V90120TPPCFG2, V90120TPPCG2T, VS70120CFG, VS70120CFGE, VS70120CFGG, VS70120PCGT, VS70120TPFG, VS7040BMGT, VS7040GRACQG, VS7040PCGT, VS7080BMGT, VS7080BRGI, VS7080BRGIM, VS7080CFG, VS7080CFGE, VS7080GRACQG, VS7080PCGT, VS7080TPPCFG, VS7080TPPCGT, VS90120CFG, VS90120CFGE, VS90120CFGG, VS90120PCGP, VS90120PCGT, VS90160CFG, VS90160CFGE, VS9040BMGT, VS9040PCGS, VS9040GRACQG, VS9040PCGT, VS9040PCGT, VS9080BMGT, VS9080BRGI, VS9080BRGIM, VS9080CFG, VS9080CFGE, VS9080PCGS, VS9080GRACQG, VS9080PCGP, VS9080PCGT, VS9080TPPCFG, VS9080TPPCGT		

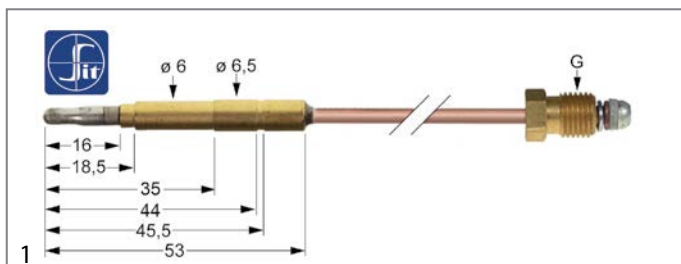

código	107876	referencia	672.168.00
descripción	termopar SIT M9x1 L 850mm conexión para conector ø6,0(6,5)mm		
Para modelos:	V7040FTRGVCR, V7080FTRGVCR, V9040FTRGVCR, V9080FTRGVCR, V9080FTRRGCR, VS7040FTGT, VS7040FTGVCR, VS7040FTGVT, VS7040FTRGT, VS7040FTRGVT, VS7080FTGT, VS7080FTGVCR, VS7080FTGVT, VS7080FTRGT, VS7080FTRGVT, VS7080FTRRGVC, VS7080FTRRGVT, VS9040FTGCR, VS9040FTGVT, VS9040FTGVCR, VS9040FTGVT, VS9040FTRGCR, VS9040FTRGT, VS9040FTRGVT, VS9080FTGCR, VS9080FTGT, VS9080FTGVCR, VS9080FTGVT, VS9080FTRGCR, VS9080FTRGT, VS9080FTRGVT, VS9080FTRRG, VS9080FTRRGVC, VS9080FTRRGVT		

termopares insertables con interrupción

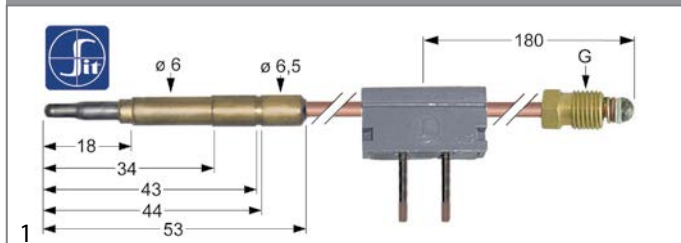

código	107864	referencia	672.167.00
descripción	termopar SIT con interruptor M9x1 L 600mm conexión para conector ø6,0(6,5)mm conexión para soldadura		
Para modelos:	VS7040FRG17VL, VS7080FRG17VL, VS9040FRG17VL, VS9040FRG21VL, VS9080FRG17VL, VS9080FRG21VL		

quemadores de gas

quemadores de cocina

accesorios

parrillas de quemador



código	210132	referencia	681.008.14
descripción	rejilla de quemador An 340mm L 570mm apto para serie 700		
Para modelos:	V70120TPPCFG2, V70120TPPCG2T, VS70120CFG, VS70120CFGE, VS70120CFGG, VS70120PCGT, VS70120TPFG, VS7040PCGT, VS7080CFG, VS7080CFGE, VS7080PCGT, VS7080TPPCFG, VS7080TPPCGT		
accesorios para	210132		
	código	210050	referencia —
	estrella reductora L 260mm An 260mm acero cromado apto para universal		



código	210060	referencia	681.019.14
descripción	rejilla de quemador An 400mm L 400mm esmaltado		
Para modelos:	V90120TPPCFG2, V90120TPPCG2T, VS90120CFG, VS90120CFGE, VS90120CFGG, VS90120PCGP, VS90120PCGT, VS90120TPFG, VS90160CFG, VS90160CFGE, VS9040PCGP, VS9040PCGT, VS9080CFG, VS9080CFGE, VS9080PCGP, VS9080PCGT, VS9080TPPCFG, VS9080TPPCGT		

mezcladores de aire



código	103127	referencia	672.016.00
descripción	casquillo de mezcla de aire L 36mm ø ext. 40mm int.ø 36mm aluminio		
Para modelos:	V70120TPPCFG2, V70120TPPCG2T, V90120TPPCFG2, V90120TPPCG2T, VS70120CFG, VS70120CFGE, VS70120CFGG, VS70120PCGT, VS70120TPFG, VS7040PCGT, VS7080CFG, VS7080CFGE, VS7080PCGT, VS7080TPPCFG, VS7080TPPCGT, VS90120CFG, VS90120CFGE, VS90120CFGG, VS90120PCGP, VS90120PCGT, VS90160CFG, VS90160CFGE, VS9040PCGP, VS9040PCGT, VS9080CFG, VS9080CFGE, VS9080PCGP, VS9080PCGT, VS9080TPPCFG, VS9080TPPCGT		

accesorios para	103127		
	código	103118	referencia —
	tapa de quemador ø 61mm		
	código	103119	referencia —
	anillo de quemador para ø de tapa de quemador 61mm		

Continúa en la página siguiente



accesorios para	103127			
	código	103120	referencia	—
	cabezal de quemador para ø de tapa de quemador 61mm			
	código	103121	referencia	672.010.00
	venturi			
	código	103122	referencia	673.020.00
	soporte de quemador ø 35mm H 82mm soporte de boquilla M10x1 distancia de sujeción 55mm empalme M16x1,5mm con portaboquillas			
	código	103124	referencia	672.101.00
	cabezal de quemador E ø 150mm para ø de tapa de quemador 110mm 7.5kW código 672.077 A			
	código	103125	referencia	672.079.00
	tapa de quemador D ø 110mm 5.5kW taladro ø 2.6mm con orificio central			
	código	103126	referencia	672.093.00
	tapa de quemador E ø 110mm 7.5kW taladro ø 3mm con orificio central			
	código	105067	referencia	672.078.00
	tapa de quemador C ø 84mm 3.5kW			
	código	105069	referencia	672.076.00
	cabezal de quemador C para ø de tapa de quemador 84mm 3.5kW			
	código	105070	referencia	672.077.00
	cabezal de quemador D ø 150mm para ø de tapa de quemador 110mm 5.5kW código 672.077 E			

	1			
código	104693	referencia	941.124.00	
descripción	mezclador de aire H 6mm ø ext. 31mm int.ø 10mm agujero ø 6.5 6 orificiosmm			
Para modelos:	V70120TPPCFG2, V70120TPPCG2T, V90120TPPCFG2, V90120TPPCG2T, VS70120CFG, VS70120TPFG, VS7080CFG, VS7080TPFG, VS7080TPPCFG, VS7080TPPCGT, VS90120CFG, VS90120TPFG, VS90160CFG, VS9080CFG, VS9080TPFG, VS9080TPPCFG, VS9080TPPCGT			

	1			
código	104696	referencia	923.271.00	
descripción	mezclador de aire ø ext. 95mm espesor 0.75mm agujero ø 10mm quemador circular			
Para modelos:	VS70120TPFG, VS7080TPFG, VS7080TPGT, VS90120TPFG, VS9080TPFG, VS9080TPGT			

	1			
código	105711	referencia	672.133.00	
descripción	tubo de mezcla de aire L 42mm ø ext. 20mm latón			
Para modelos:	VS7040FRGS13, VS7040GRL, VS7080FRGS13, VS7080GRL, VS9040FRGS13, VS9040FRGS20, VS9040GRL, VS9080FRGS13, VS9080FRGS20, VS9080GRL			

quemadores tubulares

quemadores tubulares



código	106846	referencia	972.017.00	
descripción	quemador tubular 2 filas L 610mm An 220mm ømm H 47mm grill de piedra volcánica			
Para modelos:	VS9040GRL, VS9080GRL			



código	107880	referencia	672.174.00	
descripción	quemador tubular 3 filas L 450mm An 245mm ø 25mm para grill			
Para modelos:	VS7040GRACQG, VS7080GRACQG			



código	104689	referencia	972.043.00	
descripción	quemador tubular 3 filas L 620mm An 250mm ø 27mm para grill			
Para modelos:	VS9040GRACQG, VS9080GRACQG			



código	104691	referencia	672.153.00	
descripción	quemador tubular L 520mm An 200mm ø 25mm H 60mm para sartén basculante			
Para modelos:	V7040FTRGVCRT, V7080FTRGVCRT, V9040FTRGVCRT, V9080FTRGVCRT, V9080FTRRGCR, VS7040FTGT, VS7040FTGVCRT, VS7040FTGV, VS7040FTRGT, VS7040FTRGVT, VS7080FTGT, VS7080FTGVCRT, VS7080FTGV, VS7080FTRGT, VS7080FTRGVT, VS7080FTRRG, VS7080FTRRGVC, VS7080FTRRGVT, VS9040FTGCRT, VS9040FTGT, VS9040FTGVCRT, VS9040FTGV, VS9080FTGCRT, VS9080FTGT, VS9080FTGVCRT, VS9080FTGV, VS9080FTRGCRT, VS9080FTRGT, VS9080FTRGVT, VS9080FTRRG, VS9080FTRRGVC, VS9080FTRRGVT			





código	104690	referencia	672.183.00	
descripción	quemador tubular L 590mm An 585mm ø 25mm H 170mm sartén basculante para modelo 70/80 BRG			
Para modelos:	VS7080BRGI, VS7080BRGIM			





			
1			
código	104797	referencia	972.051.00
descripción	quemador tubular L 590mm An 585mm ø 25mm H 170mm sartén basculante para modelo 90/80 BRG		
Para modelos:	VS9080BRGI, VS9080BRGIM		

			
1			
código	104694	referencia	672.053.00
descripción	quemador tubular ø 29/32/29mm para horno de GAS		
Para modelos:	VS70120CFGG, VS90120CFGG		

			
1			
código	105515	referencia	972.041.00
descripción	quemador tubular ø 40mm Anmm Hmm L 250mm brida ø 61mm baño maría		
Para modelos:	VS7040BMGT, VS9040BMGT		

			
1			
código	103360	referencia	972.042.00
descripción	quemador tubular ø 40mm L 600mm anchura brida 25mm longitud brida 48mm		
Para modelos:	VS7080BMGT, VS9080BMGT		

			
1			
código	105160	referencia	672.072.15
descripción	quemador tubular ø 50mm Anmm Hmm L 428mm anchura brida 71mm marmita brida ø 75mm		
Para modelos:	VS9040CPGS, VS9080CPGS		
repuestos para	105160		
	código	105159	referencia
			—
	 tapa terminal apto para quemador para cocedora de pasta		

			
1			
código	105523	referencia	972.040.00
descripción	quemador tubular ø 50mm Anmm Hmm L 475mm brida ø 75mm		
Para modelos:	VS9080PGI150		

			
1			
código	103358	referencia	672.145.00
descripción	quemador tubular ø 50mm L 343mm anchura brida 25mm longitud brida 60mm cocedora de pasta		
Para modelos:	VS7040CPGS, VS7080CPGS		

			
1			
código	103359	referencia	672.175.00
descripción	quemador tubular ø 50mm L 365mm anchura brida 25mm longitud brida 60mm		
Para modelos:	VS7040FRG17VL, VS7080FRG17VL, VS9040FRG17VL, VS9080FRG17VL		

			
1			
código	103343	referencia	972.045.00
descripción	quemador tubular ø 52mm L 490mm anchura brida 24mm longitud brida 60mm freidora		
Para modelos:	VS9040FRG21VL, VS9080FRG21VL		

parrillas para grill de piedra volcánica

			
1			
código	211053	referencia	9111068.00
descripción	parrilla de piedra volcánica L 625mm An 325mm H 36mm acero inoxidable		
Para modelos:	VS9040GRL, VS9080GRL		

quemadores tubulares



1

código	105401	referencia	672.181.00
descripción	quemador L 300mm An 75mm H 42mm para freidora		
Para modelos:	VS7040FRGS13, VS7080FRGS13, VS9040FRGS13, VS9040FRGS20, VS9080FRGS13, VS9080FRGS20		

quemadores para placas radiantes



1

código	105485	referencia	972.044.00
descripción	quemador para placas radiantes ø 65mm H 102mm L 284mm		
Para modelos:	V70120TPPCFG2, V70120TPPCG2T, V90120TPPCFG2, V90120TPPCG2T, VS7080TPPCFG, VS7080TPPCGT, VS9080TPPCFG, VS9080TPPCGT		

sopletes



1

código	107930	referencia	12039680
descripción	quemador L 250mm ø 38mm horno a vapor combinado FAGOR		
Para modelos:	AIC0038-F, AIC0076-F		



1

código	107929	referencia	12039583
descripción	quemador L 260mm ø 37.5mm para horno a vapor combinado FAGOR		
Para modelos:	AIC0038-F, AIC0040-F		



1

código	107927	referencia	12039556
descripción	quemador L 270mm ø 38mm para horno a vapor combinado		
Para modelos:	AIC0040-F, AIC0044-F, AIC0077-F, AIC0079-F		



1

código	107925	referencia	12039442
descripción	quemador L 300mm ø 44mm para horno a vapor combinado FAGOR		
Para modelos:	AIC0042-F, AIC0046-F, AIC0078-F, AIC0080-F		



1

código	107899	referencia	12044424
descripción	quemador L 435mm ø 52mm para horno a vapor combinado FAGOR		
Para modelos:	AIC0044-F		

accesorios

portaboquillas



1





código	104699	referencia	675.511.00
descripción	portaboquillas L 153mm racor tubular 1/2" M M14x1		
Para modelos:	VS7040FRGS13, VS7080FRGS13, VS9040FRGS13, VS9080FRGS13		



1

código	104697	referencia	675.512.00
descripción	portaboquillas L 225mm racor tubular 1/2" M M14x1		
Para modelos:	VS9040FRGS20, VS9080FRGS20		



			
1			
código	104108	referencia	673.023.00
descripción	portabojas soporte de boquilla M10x1 tubo ø 10mm entrada gas M16x1,5 salida gas M14x1		
Para modelos:	VS7080BRGI, VS7080BRGIM, VS9080BRGI, VS9080BRGIM		
accesorios para	104108		
	código	referencia	673.024.00
	 tuerca rosca M14x1 H 3.5mm EC 18 latón UE 1 pzs		
	código	referencia	—
	 parte inferior de quemador para ø de tapa de quemador 80mm 3.5kW		
	código	referencia	—
	 parte inferior de quemador para ø de tapa de quemador 100mm 6.4kW		

boquillas de gas

juegos de boquillas de gas

			
1			
código	103346	referencia	265.034.13
descripción	juego de boquillas de gas gas natural/licuado 70/80 BRG		
Para modelos:	VS7080BRGI, VS7080BRGIM		

			
1			
código	103356	referencia	265.035.13
descripción	juego de boquillas de gas gas natural/licuado BRG90/80EM		
Para modelos:	VS9080BRGI, VS9080BRGIM		

materiales auxiliares de gas

uniones roscadas

anillos cortantes

			
1			
código	101000	referencia	12008775
descripción	anillo cortante para tubo ø 16mm L 10.5mm latón UE 1 pzs		
Para modelos:	AIC0038-F, AIC0040-F, AIC0042-F, AIC0044-F, AIC0046-F, AIC0078-F, AIC0079-F, AIC0080-F		

tuercas de racor

			
1			
código	106331	referencia	12008085
descripción	tuerca de racor rosca M26x1,5 EC 30 L 17.5mm latón para ø de tubo 17mm		
Para modelos:	AIC0038-F, AIC0040-F, AIC0042-F, AIC0044-F, AIC0046-F, AIC0079-F, AIC0080-F		

tuberías de gas

tuberías de gas principales

específico del fabricante

			
1			
código	109204	referencia	631.196.00
descripción	línea de gas tubo ø 6mm L 255mm An 70mm empalme con racor para marmita para presostato		
Para modelos:	VS7080PEI50, VS7080PGI50		

tubos flexibles de gas

racores de tubo

			
1			
código	107879	referencia	678.084.00
descripción	pieza T pieza T rosca 1/4" para tubo ø 6mm L 55mm latón gas		
Para modelos:	VS7080PEI50, VS7080PGI50, VS9080PEI150, VS9080PGI150		

componentes específicos

para frigoríficos

cajas y paneles frontales

rieles guía



código	701389	referencia	17000226
descripción	cremallera L 530mm An 20mm H 14mm inox forma U pos. de montaje ambos lados par		
Para modelos:	BNA0030-F, BNA0031-F, BNA0036-F, BNA0044-F, BNA0056-F, VTGB2A-F, VTGB2-F, VTGB3A-F, VTGB3-F, VTGB4-F		

puertas

puertas



código	694689	referencia	01A01KA108
descripción	puerta An 700mm H 1600mm espesor 47mm FRENOX tope derecho/izquierdo		
Para modelos:	BMA0021-F, BMA0024-F, BMA0026-F, BMA0028-F, BMA0032-F, BMA0035-F, BMA0036-F, BMB0028-F, BMB0034-F, BMB0036-F, BMC0015-F, BMC0016-F		

para mesas frías

puertas



código	694687	referencia	01A01KA100
descripción	puerta tope derecho/izquierdo apto para FRENOX An 450mm H 660mm espesor 45mm FRENOX sin bisagra		
Para modelos:	BNA0030-F, BNA0031-F, BNA0036-F, BNA0037-F, BNA0044-F, BNA0045-F, BNA0052-F, BNA0053-F, BNA0054-F, BNA0055-F, BNA0056-F, BNA0057-F, BNB0010-F, BNB0011-F, BNB0012-F, BNB0013-F, BNB0014-F, BNB0015-F, CCZ0036-F, CCZ0037-F, VTGB2A-F, VTGB2-F, VTGB3A-F, VTGB3-F, VTGB4A-F, VTGB4-F		

para baño-maría

recambios y accesorios



código	692889	referencia	984.006.00
descripción	imán de puerta H 6mm ø 20mm M5 rosca L 15mm		
Para modelos:	V70120TPPCFG2, V90120TPPCFG2, VS70120B, VS70120CFG, VS70120CFGE, VS70120TPFG, VS7040B, VS7040CPES, VS7040CPGS, VS7040FRE10, VS7040FRE17X, VS7040FRE88, VS7040FRG17VL, VS7040FRGS13, VS7040GRL, VS7080B, VS7080CPES, VS7080CPGS, VS7080FRE10, VS7080FRE17X, VS7080FRG17VL, VS7080FRGS13, VS7080GRL, VS90120B, VS90120CFG, VS90120CFGE, VS90120PCGP, VS90120TPFG, VS9040B, VS9040CPES, VS9040CPGS, VS9040FRE15, VS9040FRE17, VS9040FRE21, VS9040FRE88, VS9040FRG17VL, VS9040FRG21VL, VS9040FRGS13, VS9040FRGS20, VS9040GRL, VS9040PCGP, VS9080B, VS9080CPES, VS9080CPGS, VS9080FRE15, VS9080FRE17, VS9080FRE21, VS9080FRG17VL, VS9080FRG21VL, VS9080FRGS13... (Otros modelos se puede ver en la tienda web)		



1

código	692796	referencia	256.431.00
descripción	kit de sujeción hexagonal L 31mm rosca M5		
Para modelos:	VS70120B, VS7040B, VS7040CPES, VS7040CPGS, VS7040FRE10, VS7040FRE17X, VS7040FRE88, VS7040FRG17VL, VS7040FRGS13, VS7040GRL, VS7080B, VS7080CPES, VS7080CPGS, VS7080FRE10, VS7080FRE17X, VS7080FRG17VL, VS7080FRGS13, VS7080GRL, VS90120B, VS90120PCGP, VS9040B, VS9040CPES, VS9040CPGS, VS9040FRE15, VS9040FRE17, VS9040FRE21, VS9040FRE88, VS9040FRG17VL, VS9040FRG21VL, VS9040FRGS13, VS9040FRGS20, VS9040GRL, VS9040PCGP, VS9080B, VS9080CPES, VS9080CPGS, VS9080FRE15, VS9080FRE17, VS9080FRE21, VS9080FRG17VL, VS9080FRG21VL, VS9080FRGS13, VS9080FRGS20, VS9080GRL, VS9080PCGP		



1

código	705023	referencia	610.272.00
descripción	rasqueta An 100mm L 420mm		
Para modelos:	VS7040GRACQE, VS7040GRACQG, VS7080GRACQE, VS7080GRACQG, VS9040GRACQE, VS9040GRACQG, VS9080GRACQE, VS9080GRACQG		

para cocina vitrocerámica

recambios y accesorios



1

código	694978	referencia	256.424.00
descripción	kit de sujeción		
Para modelos:	VS7080CFVE, VS7080PVET, VS9040PVET, VS9080CFVE, VS9080PVET		

para freidoras

recambios y accesorios



1

código	692886	referencia	6211992.00
descripción	chapa protectora cubierta para freidora L 210mm An 60mm H 38mm pos. de montaje resistencia		
Para modelos:	VS7040FRE10, VS7080FRE10		



1

código	692778	referencia	611.042.00
descripción	cubierta para soporte resistencia para freidora L 64mm An 56mm H 80mm pos. de montaje derecho		
Para modelos:	VS7040FRE10, VS7080FRE10, VS9040FRE15, VS9080FRE15		



1

código	692810	referencia	256.420.00
descripción	cubierta para soporte resistencia para freidora L 64mm An 56mm H 80mm pos. de montaje izquierdo		
Para modelos:	VS7040FRE10, VS7080FRE10, VS9040FRE15, VS9080FRE15		



1

código	692796	referencia	256.431.00
descripción	kit de sujeción hexagonal L 31mm rosca M5		
Para modelos:	VS70120B, VS7040B, VS7040CPES, VS7040CPGS, VS7040FRE10, VS7040FRE17X, VS7040FRE88, VS7040FRG17VL, VS7040FRGS13, VS7040GRL, VS7080B, VS7080CPES, VS7080CPGS, VS7080FRE10, VS7080FRE17X, VS7080FRG17VL, VS7080FRGS13, VS7080GRL, VS90120B, VS90120PCGP, VS9040B, VS9040CPES, VS9040CPGS, VS9040FRE15, VS9040FRE17, VS9040FRE21, VS9040FRE88, VS9040FRG17VL, VS9040FRG21VL, VS9040FRGS13, VS9040FRGS20, VS9040GRL, VS9040PCGP, VS9080B, VS9080CPES, VS9080CPGS, VS9080FRE15, VS9080FRE17, VS9080FRE21, VS9080FRG17VL, VS9080FRG21VL, VS9080FRGS13, VS9080FRGS20, VS9080GRL, VS9080PCGP		

			
1			
código	692795	referencia	941.130.00
descripción	placa de sujeción L 35mm An 10mm H 8mm M5 distancia de sujeción 17mm		
Para modelos:	V080FTREVCRT, V70120TPPCFG2, V70120TPPCG2T, V7040FTREVCRT, V7040FTRGVCRT, V7080FTRGVCRT, V90120TPPCFG2, V90120TPPCG2T, V9040FTREVCRT, V9040FTRGVCRT, V9080FTREVCRT, V9080FTRGVCRT, V9080FTRRECRT, V9080FTRRGCRRT, VS70120CFG, VS70120CFGE, VS70120CFGG, VS70120PCGT, VS70120TPFG, VS7040BMET, VS7040BMFEP, VS7040BMGT, VS7040CPES, VS7040CPGS, VS7040FRE10, VS7040FRE17X, VS7040FRE88, VS7040FRG17VL, VS7040FRGS13, VS7040FTET, VS7040FTEVCRT, VS7040FTEVT, VS7040FTGT, VS7040FTGVCRT, VS7040FTGVT, VS7040FTRET, VS7040FTREVT, VS7040FTRGT, VS7040FTRGVT, VS7040GRACQE, VS7040GRACQG, VS7040GRL, VS7040PCEQT, VS7040PCET, VS7040PCGT, VS7040SPET, VS7080BMET, VS7080BMFEP, VS7080BMGT, VS7080BREI... (Otros modelos se puede ver en la tienda web)		

imanes de puerta

			
1			
código	692889	referencia	984.006.00
descripción	imán de puerta H 6mm ø 20mm M5 rosca L 15mm		
Para modelos:	V70120TPPCFG2, V90120TPPCFG2, VS70120B, VS70120CFG, VS70120CFGE, VS70120TPFG, VS7040B, VS7040CPES, VS7040CPGS, VS7040FRE10, VS7040FRE17X, VS7040FRE88, VS7040FRG17VL, VS7040FRGS13, VS7040GRL, VS7080B, VS7080CPES, VS7080CPGS, VS7080FRE10, VS7080FRE17X, VS7080FRG17VL, VS7080FRGS13, VS7080GRL, VS90120B, VS90120CFG, VS90120CFGE, VS90120PCGP, VS90120TPFG, VS9040B, VS9040CPES, VS9040CPGS, VS9040FRE15, VS9040FRE17, VS9040FRE21, VS9040FRE88, VS9040FRG17VL, VS9040FRG21VL, VS9040FRGS13, VS9040FRGS20, VS9040GRL, VS9040PCGP, VS9080B, VS9080CPES, VS9080CPGS, VS9080FRE15, VS9080FRE17, VS9080FRE21, VS9080FRG17VL, VS9080FRG21VL, VS9080FRGS13... (Otros modelos se puede ver en la tienda web)		

otros

			
1			
código	692776	referencia	983.009.00
descripción	estribo de retención para resistencia		
Para modelos:	VS9040FRE15, VS9080FRE15		

para planchas grill

recambios y accesorios

			
1			
código	692779	referencia	631.175.00
descripción	empalme de desagüe para plancha grill ø 45mm L 60mm An 85mm distancia de sujeción 65mm		
Para modelos:	V9080FTRRECRT, V9080FTRRGCRRT, VS7040FTET, VS7040FTGT, VS7040FTRET, VS7040FTRGT, VS7080FTET, VS7080FTGT, VS7080FTRET, VS7080FTRGT, VS7080FTRRET, VS7080FTRRG, VS9040FTECRT, VS9040FTET, VS9040FTGCRT, VS9040FTGT, VS9040FTRECRT, VS9040FTRET, VS9040FTRGCRRT, VS9040FTRGT, VS9080FTECRT, VS9080FTET, VS9080FTGCRT, VS9080FTGT, VS9080FTRECRT, VS9080FTRET, VS9080FTRGCRRT, VS9080FTRGT, VS9080FTRRET, VS9080FTRRG		

			
1			
código	692805	referencia	683.028.00
descripción	gancho para placa radiante L 360mm		
Para modelos:	V70120TPPCFG2, V70120TPPCG2T, V90120TPPCFG2, V90120TPPCG2T, VS70120TPFG, VS7080TPFG, VS7080TPGT, VS7080TPPCFG, VS7080TPPCGT, VS90120TPFG, VS9080TPFG, VS9080TPGT, VS9080TPPCFG, VS9080TPPCGT		

			
1			
código	692889	referencia	984.006.00
descripción	imán de puerta H 6mm ø 20mm M5 rosca L 15mm		
Para modelos:	V70120TPPCFG2, V90120TPPCFG2, VS70120B, VS70120CFG, VS70120CFGE, VS70120TPFG, VS7040B, VS7040CPES, VS7040CPGS, VS7040FRE10, VS7040FRE17X, VS7040FRE88, VS7040FRG17VL, VS7040FRGS13, VS7040GRL, VS7080B, VS7080CPES, VS7080CPGS, VS7080FRE10, VS7080FRE17X, VS7080FRG17VL, VS7080FRGS13, VS7080GRL, VS90120B, VS90120CFG, VS90120CFGE, VS90120PCGP, VS90120TPFG, VS9040B, VS9040CPES, VS9040CPGS, VS9040FRE15, VS9040FRE17, VS9040FRE21, VS9040FRE88, VS9040FRG17VL, VS9040FRG21VL, VS9040FRGS13, VS9040FRGS20, VS9040GRL, VS9040PCGP, VS9080B, VS9080CPES, VS9080CPGS, VS9080FRE15, VS9080FRE17, VS9080FRE21, VS9080FRG17VL, VS9080FRG21VL, VS9080FRGS13... (Otros modelos se puede ver en la tienda web)		

 <p>1</p>			
código	692795	referencia	941.130.00
descripción	placa de sujeción L 35mm An 10mm H 8mm M5 distancia de sujeción 17mm		
Para modelos:	V080FTREVCRT, V70120TPPCFG2, V70120TPPCG2T, V7040FTREVCRT, V7040FTRGVCRT, V7080FTRGVCRT, V90120TPPCFG2, V90120TPPCG2T, V9040FTREVCRT, V9040FTRGVCRT, V9080FTREVCRT, V9080FTRGVCRT, V9080FTRREVCRT, V9080FTRRGVCRT, VS70120CFG, VS70120CFGE, VS70120CFGG, VS70120PCGT, VS70120TPFG, VS7040BMET, VS7040BMFEP, VS7040BMGT, VS7040CPES, VS7040CPGS, VS7040FRE10, VS7040FRE17X, VS7040FRE88, VS7040FRG17VL, VS7040FRGS13, VS7040FTET, VS7040FTEVCRT, VS7040FTEVT, VS7040FTGT, VS7040FTGVCRT, VS7040FTGVT, VS7040FTRET, VS7040FTREVT, VS7040FTRGT, VS7040FTRGVT, VS7040GRACQE, VS7040GRACQG, VS7040GRL, VS7040PCEQT, VS7040PCET, VS7040PCGT, VS7040SPET, VS7080BMET, VS7080BMFEP, VS7080BMGT, VS7080BREI...(Otros modelos se puede ver en la tienda web)		

<p>cubetas</p>  <p>1</p>			
código	696805	referencia	6111127.13
descripción	bandeja colectora de grasa para plancha grill L 175mm An 185mm H 110mm		
Para modelos:	VS7040FTET, VS7040FTRET, VS9040FTECRT, VS9040FTET, VS9040FTRECRT, VS9040FTRET		

 <p>1</p>			
código	696811	referencia	6111249.00
descripción	bandeja colectora de grasa para plancha grill L 270mm An 205mm H 110mm		
Para modelos:	V080FTREVCRT, V7080FTRGVCRT, V9080FTREVCRT, V9080FTRGVCRT, V9080FTRRGVCRT, VS7080FTEVCRT, VS7080FTEVT, VS7080FTGT, VS7080FTGVCRT, VS7080FTGVT, VS7080FTREVT, VS7080FTRGT, VS7080FTRGVT, VS7080FTRREVC, VS7080FTRREVT, VS7080FTRRG, VS7080FTRRGVC, VS7080FTRRGVT, VS9080FTEVCRT, VS9080FTEVT, VS9080FTGCRT, VS9080FTGT, VS9080FTGVCRT, VS9080FTGVT, VS9080FTREVT, VS9080FTRGVCRT, VS9080FTRGT, VS9080FTRGVT, VS9080FTRREVC, VS9080FTRREVT, VS9080FTRRG, VS9080FTRRGVC, VS9080FTRRGVT		

<p>para hornos a convección/combinados</p> <p>unidades de salida</p> <p>bandejas recogegotas</p>  <p>1</p>			
código	696855	referencia	12039485
descripción	bandeja recogegotas L 540mm plástico An 44.5mm		
Para modelos:	AIC0037-F, AIC0038-F, AIC0039-F, AIC0040-F, AIC0071-F, AIC0072-F, AIC0076-F, AIC0077-F		

<p>válvulas de desagüe</p>  <p>1</p>			
código	696854	referencia	12126816
descripción	pileta de desagüe para horno a vapor combinado		
Para modelos:	AIC0044-F, AIC0045-F, AIC0046-F		

 <p>1</p>			
código	696858	referencia	12043409
descripción	casquillo int.ø 4mm ø ext. 8mm L 5.5mm		
Para modelos:	AIC0037-F, AIC0038-F, AIC0039-F, AIC0040-F, AIC0041-F, AIC0043-F, AIC0044-F, AIC0045-F, AIC0046-F, AIC0071-F, AIC0072-F, AIC0073-F, AIC0074-F, AIC0075-F, AIC0076-F, AIC0077-F, AIC0079-F, AIC0080-F		

 <p>1</p>			
código	696856	referencia	12023506
descripción	casquillo int.ø 7mm ø ext. 11mm L 8mm		
Para modelos:	AIC0043-F, AIC0044-F, AIC0045-F, AIC0046-F, AIC0074-F, AIC0075-F, AIC0079-F, AIC0080-F		

generadores de vapor

generadores de vapor



1

código	692897	referencia	12046049
descripción	generador de vapor L 290mm An 120mm H 300mm		
Para modelos:	AIC0039-F		



1

código	692906	referencia	12046048
descripción	generador de vapor L 300mm An 120mm H 420mm		
Para modelos:	AIC0037-F		



1

código	696836	referencia	12046053
descripción	generador de vapor L 310mm An 120mm H 530mm		
Para modelos:	AIC0041-F, AIC0043-F		

tuberías de vapor



1

código	521283	referencia	12047930
descripción	tubo de vapor L 200mm An 85mm ø 53mm para horno a vapor combinado generador de vapor		
Para modelos:	AIC0037-F, AIC0039-F, AIC0041-F, AIC0043-F		

recambios y accesorios



1

código	551460	referencia	12023647
descripción	tapa con rosca hembra ø 38mm		
Para modelos:	AIC0037-F, AIC0038-F, AIC0039-F, AIC0040-F, AIC0041-F, AIC0042-F, AIC0043-F, AIC0044-F, AIC0045-F, AIC0046-F		

tubos flexibles



1

código	696852	referencia	12024425
descripción	tubo flexible int.ø 30/23mm ø ext. 36/30mm L 177mm para horno a vapor combinado		
Para modelos:	AIC0041-F, AIC0042-F, AIC0045-F, AIC0046-F		



1

código	530918	referencia	12039649
descripción	tubo flexible int.ø 30mm ø ext. 40mm L 110mm para generador de vapor		
Para modelos:	AIC0038-F, AIC0040-F, AIC0041-F, AIC0042-F, AIC0043-F, AIC0044-F, AIC0045-F, AIC0046-F		



1

código	530919	referencia	12044832
descripción	tubo flexible int.ø 73mm ø ext. 85mm L 150mm para generador de vapor		
Para modelos:	AIC0046-F		

macánica de puertas

accesorios



1			
código	696851	referencia	12022138
descripción	placa de asiento An 40mm chapa de acero tincado L 44mm		
Para modelos:	AIC0043-F, AIC0044-F, AIC0045-F, AIC0046-F, AIC0074-F, AIC0075-F, AIC0079-F, AIC0080-F		

otros



1			
código	692330	referencia	12022242
descripción	atomizador para horno a vapor combinado L 97mm ø 43mm agujero ø 10mm		
Para modelos:	AIC0074-F		



1			
código	698491	referencia	12024419 12113061
descripción	contenedor de nivel regulación de nivel taladro ø 17mm L 205mm rosca M12 An 28mm ø 20.5mm H 80mm		
Para modelos:	AIC0037-F, AIC0038-F, AIC0039-F, AIC0040-F, AIC0041-F, AIC0042-F, AIC0043-F, AIC0044-F, AIC0045-F, AIC0046-F		



1			
código	542288	referencia	12024796
descripción	cuerpo de ventilador para horno a vapor combinado tubo ø 24mm		
Para modelos:	AIC0037-F, AIC0038-F, AIC0039-F, AIC0040-F, AIC0041-F, AIC0042-F, AIC0043-F, AIC0044-F, AIC0045-F, AIC0046-F		



1			
código	691695	referencia	12024231
descripción	orificio de paso para chimenea D1 ø 80mm D2 ø 55mm goma		
Para modelos:	AIC0037-F, AIC0038-F, AIC0039-F, AIC0040-F, AIC0041-F, AIC0042-F, AIC0043-F, AIC0044-F, AIC0071-F, AIC0072-F, AIC0073-F, AIC0074-F, AIC0076-F, AIC0077-F, AIC0078-F, AIC0079-F		



1			
código	696427	referencia	12009970
descripción	tuerca de remache rosca M5 DN 4mm L 12mm inox UE 1 pzs ø 7mm EC 6		
Para modelos:	AIC0037-F, AIC0038-F, AIC0039-F, AIC0040-F, AIC0041-F, AIC0042-F, AIC0043-F, AIC0044-F, AIC0045-F, AIC0046-F, AIC0071-F, AIC0072-F, AIC0073-F, AIC0074-F, AIC0075-F, AIC0076-F, AIC0077-F, AIC0078-F, AIC0079-F, AIC0080-F		

para sartén basculante

recambios y accesorios



1			
código	514518	referencia	951.069.00
descripción	arandela ø 17.5mm plástico		
Para modelos:	VS7080BREI, VS7080BRGI, VS9080BREI, VS9080BRGI		



1			
código	692777	referencia	941.165.00
descripción	casquillo distanciador espesor 2.3mm int.ø 10mm ø ext. 15mm H 19mm		
Para modelos:	VS7080BREIM, VS7080BRGIM, VS9080BREIM, VS9080BRGIM		



1			
código	551432	referencia	561.012.00
descripción	clema plástico		
Para modelos:	VS7080BREIM, VS7080BRGIM, VS9080BREIM, VS9080BRGIM		





1

código	699450	referencia	256.460.00
descripción	kit de sujeción para bisagra		
Para modelos:	VS7080BREI, VS7080BREIM, VS7080BRGI, VS7080BRGIM, VS9080BREI, VS9080BREIM, VS9080BRGI, VS9080BRGIM		



1

código	694976	referencia	9111769.00
descripción	soporte para árbol acero zincado pos. de montaje centrado		
Para modelos:	VS7080BREI, VS7080BREIM, VS7080BRGI, VS7080BRGIM, VS9080BREI, VS9080BREIM, VS9080BRGI, VS9080BRGIM		



1

código	699597	referencia	256.461.00
descripción	kit de sujeción para bisagra para tapa EC 13		
Para modelos:	VS7080BREI, VS7080BREIM, VS7080BRGI, VS7080BRGIM, VS9080BREI, VS9080BREIM, VS9080BRGI, VS9080BRGIM		



1

código	542394	referencia	256.466.00
descripción	tubo de entrada empalme 1/2" tubo ø 25mm altura total 150mm ángulo de rotación°		
Para modelos:	VS7080BREI, VS7080BREIM, VS7080BRGI, VS7080BRGIM, VS9080BREI, VS9080BREIM, VS9080BRGI, VS9080BRGIM		



1

código	699598	referencia	941.154.00
descripción	perno L 24mm ø 14mm para sartén basculante		
Para modelos:	VS7080BREI, VS7080BREIM, VS7080BRGI, VS7080BRGIM, VS9080BREI, VS9080BREIM, VS9080BRGI, VS9080BRGIM		



1

código	694964	referencia	941.164.00
descripción	perno L 78mm ø 10mm acero inoxidable		
Para modelos:	VS7080BREIM, VS7080BRGIM, VS9080BREIM, VS9080BRGIM		

cajas y paneles frontales



1

código	692799	referencia	256.304.00
descripción	protección ø 108mm plástico		
Para modelos:	VS7080BRGI, VS7080BRGIM, VS7080PG50, VS7080PGI50, VS9080BRGI, VS9080BRGIM, VS9080PGI150		



1

código	542390	referencia	0777.10073.8 M538003000
descripción	perno roscado rosca M10x1,5		
Para modelos:	VS7080BREI, VS7080BREIM, VS7080BRGI, VS7080BRGIM, VS9080BREI, VS9080BREIM, VS9080BRGI, VS9080BRGIM		

tornillos sin fin



1

código	692891	referencia	910.732.00
descripción	barra roscada para sartén basculante int.ø 25mm ø ext. 30mm L 670mm		
Para modelos:	VS7080BREI, VS7080BRGI, VS9080BREI, VS9080BRGI		



1

código	692773	referencia	941.157.00
descripción	placa de sujeción L 60mm An 40mm H 15mm		
Para modelos:	VS7080BREI, VS7080BREIM, VS7080BRGI, VS7080BRGIM, VS9080BREI, VS9080BREIM, VS9080BRGI, VS9080BRGIM		



1 

código	530900	referencia	941.162.00
descripción	barra roscada rosca M12x1,5 acero zincado rosca L 80mm		
Para modelos:	VS7080BREIM, VS7080BRGIM, VS9080BREIM, VS9080BRGIM		

1 

código	692887	referencia	941.163.00
descripción	soporte de rodamiento bisagra para sartén basculante ø 20mm int.ø 15.5mm L 54mm		
Para modelos:	VS7080BREIM, VS7080BRGIM, VS9080BREIM, VS9080BRGIM		

otros



1

código	692798	referencia	256.471.00
descripción	espárrago de fijación L 35mm ø 12mm con tuerca con disco sartén basculante EC 19		
Para modelos:	VS7080BREI, VS7080BRGI, VS9080BREI, VS9080BRGI		
repuestos para	692798		



código	692888	referencia	941.181.00
descripción	espárrago de fijación L 35mm ø 12mm para sartén basculante EC 19		



código	692888	referencia	941.181.00
descripción	espárrago de fijación L 35mm ø 12mm para sartén basculante EC 19		
Para modelos:	VS7080BREI, VS7080BRGI, VS9080BREI, VS9080BRGI		



código	692798	referencia	256.471.00
descripción	espárrago de fijación L 35mm ø 12mm con tuerca con disco sartén basculante EC 19		

para marmitas

recambios y accesorios

1 

código	692782	referencia	641.150.00
descripción	árbol para marmita L 285mm ø ext. 16mm		
Para modelos:	VS7080PEI50, VS7080PG50, VS7080PGI50		

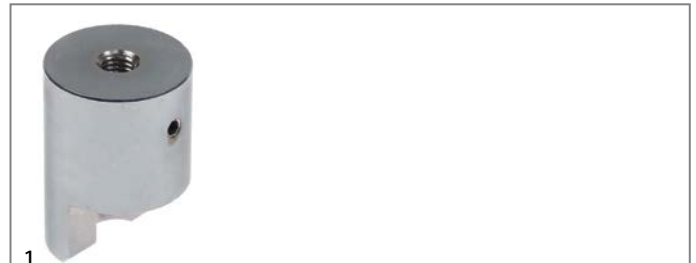

código	692797	referencia	941.138.00
descripción	casquillo para marmita ø 39mm L 55mm		
Para modelos:	VS7080PEI50, VS7080PG50, VS7080PGI50, VS9080PEI150, VS9080PGI150		



código	514528	referencia	941.137.00
descripción	casquillo para marmita tapa ø 39mm int.ø 16mm H 12mm		
Para modelos:	VS7080PEI50, VS7080PG50, VS7080PGI50, VS9080PEI150, VS9080PGI150		



código	692783	referencia	941.139.15
descripción	cojinete de ajuste para marmita ø 40/20mm L 80mm		
Para modelos:	VS7080PEI50, VS7080PG50, VS7080PGI50		

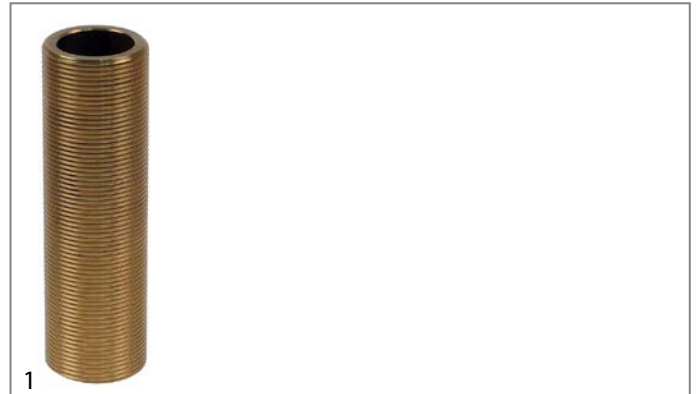

código	692787	referencia	631.195.00
descripción	pieza roscada latón L 160mm int.ø 34mm 1 1/2"		
Para modelos:	VS7080PEI50, VS7080PG50, VS7080PGI50		



1

código	692801	referencia	931.213.00
descripción	pieza roscada para grifo de vaciado L 140mm rosca 2"		
Para modelos:	VS9080PEI150, VS9080PGI150		



1

código	514517	referencia	641.149.00
descripción	soporte para marmita		
Para modelos:	VS7080PEI50, VS7080PG50, VS7080PGI50		

filtros



1

código	514521	referencia	611.373.00
descripción	filtro de desagüe para marmita L 145mm An 75mm		
Para modelos:	VS7080PEI50, VS7080PG50, VS7080PGI50, VS9080PEI150, VS9080PGI150		

otros



1

código	542398	referencia	678.082.00
descripción	entrada agua para marmita fijado		
Para modelos:	VS7080PEI50, VS7080PG50, VS7080PGI50, VS9080PEI150, VS9080PGI150		

para grill piedra volcánica



1

código	692892	referencia	9221341.00
descripción	bandeja colectora de grasa L 750mm An 157mm H 22mm		
Para modelos:	VS9040GRL, VS9080GRL		



1

código	692889	referencia	984.006.00
descripción	imán de puerta H 6mm ø 20mm M5 rosca L 15mm		
Para modelos:	V70120TPPCFG2, V90120TPPCFG2, VS70120B, VS70120CFG, VS70120CFGE, VS70120TPFG, VS7040B, VS7040CPES, VS7040CPGS, VS7040FRE10, VS7040FRE17X, VS7040FRE88, VS7040FRG17VL, VS7040FRGS13, VS7040GRL, VS7080B, VS7080CPES, VS7080CPGS, VS7080FRE10, VS7080FRE17X, VS7080FRG17VL, VS7080FRGS13, VS7080GRL, VS90120B, VS90120CFG, VS90120CFGE, VS90120PCGP, VS90120TPFG, VS9040B, VS9040CPES, VS9040CPGS, VS9040FRE15, VS9040FRE17, VS9040FRE21, VS9040FRE88, VS9040FRG17VL, VS9040FRG21VL, VS9040FRGS13, VS9040FRGS20, VS9040GRL, VS9040PCGP, VS9080B, VS9080CPES, VS9080CPGS, VS9080FRE15, VS9080FRE17, VS9080FRE21, VS9080FRG17VL, VS9080FRG21VL, VS9080FRGS13... (Otros modelos se puede ver en la tienda web)		



1

código	692809	referencia	512.002.00
descripción	mirilla medida 35x35 2 lengüeta de sujeción para grill de piedra volcánica		
Para modelos:	VS7040GRL, VS7080GRL, VS9040GRL, VS9080GRL		

para elementos neutros

puertas



1

código	692889	referencia	984.006.00
descripción	imán de puerta H 6mm ø 20mm M5 rosca L 15mm		
Para modelos:	V70120TPPCFG2, V90120TPPCFG2, VS70120B, VS70120CFG, VS70120CFGE, VS70120TPFG, VS7040B, VS7040CPES, VS7040CPGS, VS7040FRE10, VS7040FRE17X, VS7040FRE88, VS7040FRG17VL, VS7040FRGS13, VS7040GRL, VS7080B, VS7080CPES, VS7080CPGS, VS7080FRE10, VS7080FRE17X, VS7080FRG17VL, VS7080FRGS13, VS7080GRL, VS90120B, VS90120CFG, VS90120CFGE, VS90120PCGP, VS90120TPFG, VS9040B, VS9040CPES, VS9040CPGS, VS9040FRE15, VS9040FRE17, VS9040FRE21, VS9040FRE88, VS9040FRG17VL, VS9040FRG21VL, VS9040FRGS13, VS9040FRGS20, VS9040GRL, VS9040PCGP, VS9080B, VS9080CPES, VS9080CPGS, VS9080FRE15, VS9080FRE17, VS9080FRE21, VS9080FRG17VL, VS9080FRG21VL, VS9080FRGS13... (Otros modelos se puede ver en la tienda web)		



1

código	692889	referencia	984.006.00
descripción	imán de puerta H 6mm ø 20mm M5 rosca L 15mm		
Para modelos:	V70120TPPCFG2, V90120TPPCFG2, VS70120B, VS70120CFG, VS70120CFGE, VS70120TPFG, VS7040B, VS7040CPES, VS7040CPGS, VS7040FRE10, VS7040FRE17X, VS7040FRE88, VS7040FRG17VL, VS7040FRGS13, VS7040GRL, VS7080B, VS7080CPES, VS7080CPGS, VS7080FRE10, VS7080FRE17X, VS7080FRG17VL, VS7080FRGS13, VS7080GRL, VS90120B, VS90120CFG, VS90120CFGE, VS90120PCGP, VS90120TPFG, VS9040B, VS9040CPES, VS9040CPGS, VS9040FRE15, VS9040FRE17, VS9040FRE21, VS9040FRE88, VS9040FRG17VL, VS9040FRG21VL, VS9040FRGS13, VS9040FRGS20, VS9040GRL, VS9040PCGP, VS9080B, VS9080CPES, VS9080CPGS, VS9080FRE15, VS9080FRE17, VS9080FRE21, VS9080FRG17VL, VS9080FRG21VL, VS9080FRGS13... (Otros modelos se puede ver en la tienda web)		

para cuecepastas

recambios y accesorios



1

código	699392	referencia	256.216.00
descripción	bisagra 1 par para puerta		
Para modelos:	V70120TPPCFG2, V90120TPPCFG2, VS70120B, VS70120CFG, VS70120CFGE, VS70120TPFG, VS7040B, VS7040CPES, VS7040CPGS, VS7040FRE10, VS7040FRE17X, VS7040FRE88, VS7040FRG17VL, VS7040FRGS13, VS7040GRL, VS7080B, VS7080CPES, VS7080CPGS, VS7080FRE10, VS7080FRE17X, VS7080FRG17VL, VS7080FRGS13, VS7080GRL, VS90120B, VS90120CFG, VS90120CFGE, VS90120PCGP, VS90120TPFG, VS9040B, VS9040CPES, VS9040CPGS, VS9040FRE15, VS9040FRE17, VS9040FRE21, VS9040FRE88, VS9040FRG17VL, VS9040FRG21VL, VS9040FRGS13, VS9040FRGS20, VS9040GRL, VS9040PCGP, VS9080B, VS9080CPES, VS9080CPGS, VS9080FRE15, VS9080FRE17, VS9080FRE21, VS9080FRG17VL, VS9080FRG21VL, VS9080FRGS13... (Otros modelos se puede ver en la tienda web)		



1

código	692796	referencia	256.431.00
descripción	kit de sujeción hexagonal L 31mm rosca M5		
Para modelos:	VS70120B, VS7040B, VS7040CPES, VS7040CPGS, VS7040FRE10, VS7040FRE17X, VS7040FRE88, VS7040FRG17VL, VS7040FRGS13, VS7040GRL, VS7080B, VS7080CPES, VS7080CPGS, VS7080FRE10, VS7080FRE17X, VS7080FRG17VL, VS7080FRGS13, VS7080GRL, VS90120B, VS90120PCGP, VS9040B, VS9040CPES, VS9040CPGS, VS9040FRE15, VS9040FRE17, VS9040FRE21, VS9040FRE88, VS9040FRG17VL, VS9040FRG21VL, VS9040FRGS13, VS9040FRGS20, VS9040GRL, VS9040PCGP, VS9080B, VS9080CPES, VS9080CPGS, VS9080FRE15, VS9080FRE17, VS9080FRE21, VS9080FRG17VL, VS9080FRG21VL, VS9080FRGS13, VS9080FRGS20, VS9080GRL, VS9080PCGP		



1

código	692795	referencia	941.130.00
descripción	placa de sujeción L 35mm An 10mm H 8mm M5 distancia de sujeción 17mm		
Para modelos:	V080FTREVCRT, V70120TPPCFG2, V70120TPPCG2T, V7040FTREVCRT, V7040FTRGVCRT, V7080FTRGVCRT, V90120TPPCFG2, V90120TPPCG2T, V9040FTREVCRT, V9040FTRGVCRT, V9080FTREVCRT, V9080FTRGVCRT, V9080FTRRECRT, V9080FTRRGCR, VS70120CFG, VS70120CFGE, VS70120CFGG, VS70120PCGT, VS70120TPFG, VS7040BMET, VS7040BMFEP, VS7040BMGT, VS7040CPES, VS7040CPGS, VS7040FRE10, VS7040FRE17X, VS7040FRE88, VS7040FRG17VL, VS7040FRGS13, VS7040FTET, VS7040FTEVCRT, VS7040FTEVT, VS7040FTGT, VS7040FTGVCRT, VS7040FTGVT, VS7040FTRET, VS7040FTREVT, VS7040FTRGT, VS7040FTRGVT, VS7040GRACQE, VS7040GRACQG, VS7040GRL, VS7040PCEQT, VS7040PCET, VS7040PCGT, VS7040SPET, VS7080BMET, VS7080BMFEP, VS7080BMGT, VS7080BREI... (Otros modelos se puede ver en la tienda web)		



1

código	542393	referencia	256.313.00
descripción	tubo de entrada empalme 3/8" tubo ø 12mm altura total 67mm ángulo de rotación°		
Para modelos:	VS7040CPES, VS7040CPGS, VS7080CPES, VS7080CPGS, VS9040CPES, VS9040CPGS, VS9080CPES, VS9080CPGS		

para hornos

recambios y accesorios



1

código	692805	referencia	683.028.00
descripción	gancho para placa radiante L 360mm		
Para modelos:	V70120TPPCFG2, V70120TPPCG2T, V90120TPPCFG2, V90120TPPCG2T, VS70120TPFG, VS7080TPFG, VS7080TPGT, VS7080TPPCFG, VS7080TPPCGT, VS90120TPFG, VS9080TPFG, VS9080TPGT, VS9080TPPCFG, VS9080TPPCGT		



1

código	692889	referencia	984.006.00
descripción	imán de puerta H 6mm ø 20mm M5 rosca L 15mm		
Para modelos:	V70120TPPCFG2, V90120TPPCFG2, VS70120B, VS70120CFG, VS70120CFGE, VS70120TPFG, VS7040B, VS7040CPES, VS7040CPGS, VS7040FRE10, VS7040FRE17X, VS7040FRE88, VS7040FRG17VL, VS7040FRGS13, VS7040GRL, VS7080B, VS7080CPES, VS7080CPGS, VS7080FRE10, VS7080FRE17X, VS7080FRG17VL, VS7080FRGS13, VS7080GRL, VS90120B, VS90120CFG, VS90120CFGE, VS90120PCGP, VS90120TPFG, VS9040B, VS9040CPES, VS9040CPGS, VS9040FRE15, VS9040FRE17, VS9040FRE21, VS9040FRE88, VS9040FRG17VL, VS9040FRG21VL, VS9040FRGS13, VS9040FRGS20, VS9040GRL, VS9040PCGP, VS9080B, VS9080CPES, VS9080CPGS, VS9080FRE15, VS9080FRE17, VS9080FRE21, VS9080FRG17VL, VS9080FRG21VL, VS9080FRGS13... (Otros modelos se puede ver en la tienda web)		



1

código	692796	referencia	256.431.00
descripción	kit de sujeción hexagonal L 31mm rosca M5		
Para modelos:	VS70120B, VS7040B, VS7040CPES, VS7040CPGS, VS7040FRE10, VS7040FRE17X, VS7040FRE88, VS7040FRG17VL, VS7040FRGS13, VS7040GRL, VS7080B, VS7080CPES, VS7080CPGS, VS7080FRE10, VS7080FRE17X, VS7080FRG17VL, VS7080FRGS13, VS7080GRL, VS90120B, VS90120PCGP, VS9040B, VS9040CPES, VS9040CPGS, VS9040FRE15, VS9040FRE17, VS9040FRE21, VS9040FRE88, VS9040FRG17VL, VS9040FRG21VL, VS9040FRGS13, VS9040FRGS20, VS9040GRL, VS9040PCGP, VS9080B, VS9080CPES, VS9080CPGS, VS9080FRE15, VS9080FRE17, VS9080FRE21, VS9080FRG17VL, VS9080FRG21VL, VS9080FRGS13, VS9080FRGS20, VS9080GRL, VS9080PCGP		

			
1			
código	692795	referencia	941.130.00
descripción	placa de sujeción L 35mm An 10mm H 8mm M5 distancia de sujeción 17mm		
Para modelos:	V080FTREVCRT, V70120TPPCFG2, V70120TPPCG2T, V7040FTREVCRT, V7040FTRGVCRT, V7080FTRGVCRT, V90120TPPCFG2, V90120TPPCG2T, V9040FTREVCRT, V9040FTRGVCRT, V9080FTREVCRT, V9080FTRGVCRT, V9080FTRREVCRT, V9080FTRRGCRRT, VS70120CFG, VS70120CFGE, VS70120CFGG, VS70120PCGT, VS70120TPFG, VS7040BMET, VS7040BMFEP, VS7040BMGT, VS7040CPES, VS7040CPGS, VS7040FRE10, VS7040FRE17X, VS7040FRE88, VS7040FRG17VL, VS7040FRGS13, VS7040FTET, VS7040FTEVCRT, VS7040FTEVT, VS7040FTGT, VS7040FTGVCRT, VS7040FTGVT, VS7040FTRET, VS7040FTREVT, VS7040FTRGT, VS7040FTRGVT, VS7040GRACQE, VS7040GRACQG, VS7040GRL, VS7040PCEQT, VS7040PCET, VS7040PCGT, VS7040SPET, VS7080BMET, VS7080BMFEP, VS7080BMGT, VS7080BREI...(Otros modelos se puede ver en la tienda web)		

			
2			
código	692774	referencia	6221484.00
descripción	placa de sujeción L 60mm An 40mm H 1.5mm		
Para modelos:	VS7080CFVE, VS7080PVET, VS9040PVET, VS9080CFVE, VS9080PVET		

<p>otros</p> 			
1			
código	699368	referencia	935.045.13
descripción	placa inferior L 640mm An 425mm H 5mm inox		
Para modelos:	VS70120CFGG, VS90120CFGG		

para lavavajillas

calentadores de agua

calentadores de agua para lavavajillas

			
1			
código	501511	referencia	104061
descripción	calentador de agua ø 145mm L 420mm tubo ø 18/27mm		
Para modelos:	GLB0043C-60Hz		

<p>accesorios</p>			
			
1			
código	518348	referencia	468117
descripción	empalme de tubo		
Para modelos:	GLB0041, GLB0042, GLB0043C, GLB0044C		

			
1			
código	518671	referencia	12097453
descripción	empalme de tubo para calentador de agua L 54mm tubo ø 10mm		
Para modelos:	GLB0067-F, GLB0069-F, GLB0071-F, GLB0080, GLB0081, GLB0082		

<p>juntas</p>			
			
1			
código	699343	referencia	12048366
descripción	junta L 118mm An 73mm H 9mm espesor 9mm		
Para modelos:	GLB0071-F, GLB0080		

			
1			
código	698802	referencia	35510
descripción	junta L 65mm An 10mm H 4mm espesor 4mm		
Para modelos:	GLB0040		

<p>cajas y paneles frontales</p>			
<p>bridas</p>			
			
1			
código	699345	referencia	K75057
descripción	brida con junta anular H 35mm ø 130mm		
Para modelos:	GLB0047		

			
1			
código	699346	referencia	K75141
descripción	brida con junta anular H 35mm ø 130mm pos. de montaje arriba M6		
Para modelos:	GLB0047		



1

código	699252	referencia	75057
descripción	brida H 40mm ø 130mm pos. de montaje abajo		
Para modelos:	GLB0045, GLB0047, GLB0048, GLB0049, GLB0050, GLB0051		



1

código	699251	referencia	75141
descripción	brida H 65mm ø 130mm pos. de montaje arriba		
Para modelos:	GLB0045, GLB0047, GLB0048, GLB0049, GLB0050, GLB0051		

mecanismo



1

código	518634	referencia	927102
descripción	mecanismo ø árbol motor 14mm brida ø 160mm árbol motriz ø 25mm tipo VF49A60		
Para modelos:	GLB0047, GLB0048		

mecanismos de capota para lavavajillas

casquillos



1

código	505272	referencia	12025255
descripción	casquillo ø ext. 22mm int. ø 10mm L 7mm plástico		
Para modelos:	GLB0071-F, GLB0080, GLB0082		

barras guía



1

código	698803	referencia	41038
descripción	raíl de deslizamiento L 458mm pos. de montaje atrás An 21mm H 20mm		
Para modelos:	GLB0041, GLB0042, GLB0043C, GLB0044C		

otros



1

código	508375	referencia	80105
descripción	soporte de fijacion		
Para modelos:	GLB0040		



1

código	698811	referencia	41100
descripción	tope de puerta ø ext. 20mm H 20mm		
Para modelos:	GLB0043C-60Hz		

guías para cestos

soportes para cestos



1

código	699344	referencia	75058
descripción	rollo para cesto H 35mm ø 45mm		
Para modelos:	GLB0045, GLB0047, GLB0048, GLB0049, GLB0050, GLB0051		



1

código	699347	referencia	75076
descripción	tope para transporte de cestos L 25m ø 17.5mm		
Para modelos:	GLB0045, GLB0047, GLB0048, GLB0049, GLB0050, GLB0051		

cámaras de aire			
cámaras de aire			
			
1			
código	524810	referencia	144032
descripción	cámara de aire An 95mm H 150mm tubo ø 6/8mm plástico		
Para modelos:	GLB0043C-60Hz		

			
1			
código	519499	referencia	107012
descripción	cámara de aire L 46mm An 35mm H 72mm rosca 3/4" tubo ø 5.5mm plástico		
Para modelos:	GLB0043C-60Hz		
accesorios para	519499		
	código	516261	referencia 437098
	junta plana goma ø ext. 33mm int.ø 25mm espesor 2.5mm para cámara de aire UE 1 pzs		
	código	519498	referencia 417120
	tuerca rosca 3/4" H 10mm EC 30 plástico UE 1 pzs		

			
1			
código	518200	referencia	984005
descripción	cámara de aire ø 34mm H 78mm tubo ø 6mm plástico		
Para modelos:	GLB0040, GLB0041, GLB0042, GLB0043C, GLB0044C, GLB0045, GLB0047, GLB0048, GLB0049, GLB0050, GLB0051		
repuestos para	518200		
	código	504618	referencia —
	junta tórica EPDM espesor 2.62mm int.ø 15.54mm UE 1 pzs		
	código	510075	referencia —
	junta plana goma ø ext. 22mm int.ø 13mm espesor 1.5mm UE 1 pzs		
	código	510106	referencia —
	empalme de tubo para cámara de aire		

mecánicas para lavajillas de cinta transportadora			
			
1			
código	699351	referencia	75231 K75649
descripción	cubierta para excéntrica plástico D1 ø 147mm D2 ø 32.6mm		
Para modelos:	GLB0045, GLB0047, GLB0048, GLB0049, GLB0050, GLB0051		

			
1			
código	504423	referencia	927048
descripción	protección L 230mm An 95mm H 16mm agujero ø 25x7mm espesor 4mm		
Para modelos:	GLB0045, GLB0047, GLB0048, GLB0049, GLB0050, GLB0051		

tubos			
			
1			
código	698771	referencia	42028
descripción	tubo de aspiración tubo ø 60.5mm L 87mm int.ø 57mm		
Para modelos:	GLB0041, GLB0043C-60Hz, GLB0047, GLB0049		

bloques antirretorno			
			
1			
código	518486	referencia	144010
descripción	bloqueo antirretorno empalme 1/2" lavajillas tubo ø 12mm		
Para modelos:	GLB0045, GLB0047, GLB0048, GLB0049, GLB0050, GLB0051		

otros



1			
código	698871	referencia	419036
descripción	distanciador para placa electrónica L 18mm An 6mm D1 ø 6mm D2 ø 3mm		
Para modelos:	GLB0043C-60Hz, GLB0047		



1			
código	519481	referencia	927110
descripción	registro de calefacción L 440mm An 260mm H 195mm		
Para modelos:	GLB0045, GLB0047, GLB0048, GLB0049, GLB0050, GLB0051		



1			
código	698716	referencia	CWP2
descripción	soporte de placa electrónica L 34mm		
Para modelos:	GLB0043C-60Hz		

macánica de puertas

recambios y accesorios



1			
código	507579	referencia	75064
descripción	gancho de cierre para puerta		
Para modelos:	GLB0047, GLB0048, GLB0049, GLB0050, GLB0051		



1			
código	507580	referencia	75226
descripción	gancho de cierre para puerta		
Para modelos:	GLB0045, GLB0047, GLB0048, GLB0049, GLB0050, GLB0051		

varillaje



1			
código	698800	referencia	44593
descripción	barra L 670mm rosca M6/M10 ø 10mm		
Para modelos:	GLB0043C-60Hz		

placas de fricción



1			
código	517801	referencia	307012
descripción	placa de fricción L 75mm An 12mm H 10mm		
Para modelos:	GLB0040		

bisagras



1			
código	504797	referencia	35060
descripción	bisagra de puerta pos. de montaje izquierdo ø 10mm L 70mm		
Para modelos:	GLB0040		

juntas para puertas

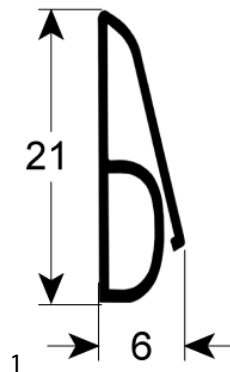

1			
código	512471	referencia	41583
descripción	junta de puerta L 740mm An 21mm		
Para modelos:	GLB0041		



código	512460	referencia	42783
descripción	junta de puerta L 800mm An 21mm		
Para modelos:	GLB0043C-60Hz		

marco de puerta

código	901694	referencia	41197
descripción	marco para puerta pos. de montaje arriba An 34mm L 595mm inox distancia de sujeción 225mm		
Para modelos:	GLB0041, GLB0042		

otros

código	698748	referencia	35013
descripción	parte lateral para puerta L 235mm An 100mm espesor 2mm		
Para modelos:	GLB0040		

uniones roscadas

código	698876	referencia	486078
descripción	tornillo rosca M6x30mm UE 1 pzs inox		
Para modelos:	GLB0041, GLB0043C, GLB0043C-60Hz, GLB0044C, GLB0045, GLB0047, GLB0048, GLB0049, GLB0050, GLB0051		

código	519498	referencia	417120
descripción	tuerca rosca 3/4" H 10mm EC 30 plástico UE 1 pzs		
Para modelos:	GLB0043C-60Hz		

código	504369	referencia	12007871
descripción	tuerca rosca 5/8" tubo (22,7mm) H 7.3mm EC 32 latón UE 1 pzs		
Para modelos:	GLB0082		

código	698874	referencia	417119
descripción	tuerca rosca M3 H 3.5mm plástico UE 1 pzs para placa electrónica		
Para modelos:	GLB0043C-60Hz, GLB0047		

cortinas

código	533008	referencia	75120
descripción	cortina An 540mm H 405mm plástico espesor 1.3mm		
Para modelos:	GLB0045, GLB0047, GLB0048, GLB0049, GLB0050, GLB0051		
accesorios para	533008		
código	533009	referencia	75121
Para modelos:	barra de cortina L 545mm ø 8mm		

código	533018	referencia	77120
descripción	cortina An 585mm H 400mm		
Para modelos:	GLB0048		



código	533007	referencia	75123
descripción	cortina An 620mm H 250mm espesor 1.4mm		
Para modelos:	GLB0045, GLB0047, GLB0048, GLB0049, GLB0050, GLB0051		

barras de cortina



código	533009	referencia	75121
descripción	barra de cortina L 545mm ø 8mm		
Para modelos:	GLB0045, GLB0047, GLB0048, GLB0049, GLB0050, GLB0051		



código	533019	referencia	75124
descripción	barra de cortina L 620mm ø 8mm		
Para modelos:	GLB0045, GLB0047, GLB0048, GLB0049, GLB0050, GLB0051		

sistemas de lavado y aclarado



código	518089	referencia	80184
descripción	anillo de soporte para brazo de lavado int.ø 40mm ø ext. 44mm espesor 3mm		
Para modelos:	GLB0040		



código	505040	referencia	12110631
descripción	casquillo para brazo de lavado		
Para modelos:	GLB0067-F, GLB0069-F, GLB0081		





código	505041	referencia	12025116
descripción	casquillo para brazo de lavado		
Para modelos:	GLB0071-F, GLB0080, GLB0082		





código	517441	referencia	41064CP
descripción	contrabrida para soporte de brazo de lavado con disco de reducción ø 70mm int.ø 63mm L 110mm An 89mm H 35mm		
Para modelos:	GLB0041, GLB0042, GLB0043C, GLB0043C-60Hz, GLB0044C		

repuestos para	517441
	código 698750 referencia 41185
	disco de reducción ø 71.5mm agujero ø 17/22mm

accesorios para	517441
	código 531605 referencia 42053
	extensión para aclarado eje ø 16mm H 122mm rosca L 12mm EC 19
	código 532603 referencia 926252
	junta tórica EPDM espesor 3.53mm int.ø 69.85mm UE 1 pzs



código	517568	referencia	41064
descripción	contrabrida para soporte de brazo de lavado ø 69mm int.ø 63mm H 35mm distancia de sujeción 64mm agujero ø 7mm		
Para modelos:	GLB0041, GLB0042, GLB0043C, GLB0043C-60Hz, GLB0044C		

accesorios para	517568
	código 531605 referencia 42053
	extensión para aclarado eje ø 16mm H 122mm rosca L 12mm EC 19
	código 532603 referencia 926252
	junta tórica EPDM espesor 3.53mm int.ø 69.85mm UE 1 pzs
	código 698750 referencia 41185
	disco de reducción ø 71.5mm agujero ø 17/22mm

			
1			
código	513270	referencia	80316
descripción	disco de reducción		
Para modelos:	GLB0040		

			
1			
código	518238	referencia	143173
descripción	distribuidor ø 12mm L 98mm		
Para modelos:	GLB0041, GLB0042, GLB0043C, GLB0043C-60Hz, GLB0045, GLB0047, GLB0048, GLB0049, GLB0050, GLB0051		

			
1			
código	518240	referencia	437078
descripción	junta plana goma ø ext. 33mm int.ø 17mm espesor 1.5mm UE 1 pzs		
Para modelos:	GLB0040, GLB0041, GLB0042, GLB0043C, GLB0044C		

			
1			
código	518434	referencia	429050
descripción	soporte de brazo de aclarado pos. de montaje arriba		
Para modelos:	GLB0040, GLB0041, GLB0042, GLB0043C, GLB0044C		

			
1			
código	518443	referencia	468165
descripción	soporte de brazo de aclarado pos. de montaje arriba		
Para modelos:	GLB0040, GLB0041, GLB0042, GLB0043C, GLB0044C, GLB0045, GLB0047, GLB0048, GLB0049, GLB0050, GLB0051		

				
1				
código	501546	referencia	12048173	
descripción	soporte de brazo de lavado pos. de montaje arriba ø 42mm H 78mm L1 340mm			
Para modelos:	GLB0071-F, GLB0080			
accesorios para	501546			
	código	532103	referencia	12049214
	junta tórica EPDM espesor 3.53mm int.ø 13.87mm UE 10 pzs			
	código	699343	referencia	12048366
	junta L 118mm An 73mm H 9mm espesor 9mm			

			
1			
código	519493	referencia	75165
descripción	tubo de lavado ø 48mm L 617mm plástico		
Para modelos:	GLB0045, GLB0047, GLB0048, GLB0050, GLB0051		

			
1			
código	513158	referencia	80365
descripción	tuerca moleteada		
Para modelos:	GLB0041, GLB0042, GLB0043C, GLB0044C		

			
1			
código	513286	referencia	80281
descripción	unión roscada		
Para modelos:	GLB0040		

para wok

			
1			
código	694580	referencia	955.016.00
descripción	cuenco para Wok para wok de inducción ø 310mm H 69mm Ceran		
Para modelos:	VS9040INDWT		

pomos

accesorios

juntas



1

código	691074	referencia	12024516
descripción	junta eje de interruptor		
Para modelos:	GLB0067-F, GLB0069-F		

manillas y volantes

volantes

volantes



1

código	694351	referencia	951.000.00
descripción	volante ø 200mm D1 ø 40mm taladro ø 18mm profundidad de taladro 23mm rosca M6 dist. del agujero 9mm ancho de ranuramm L1 40mm L2 60mm longitud de asidero 108mm con asidero abatible		
Para modelos:	VS7080BREI, VS7080BRGI, VS9080BREI, VS9080BRGI		

manillas cilíndricas

fijo



1

código	691314	referencia	651.012.00
descripción	manilla cilíndrica rosca M8 ø 28mm L 86mm		
Para modelos:	VS7080PEI50, VS7080PG50, VS7080PGI50		

asas de arco



1

código	502292	referencia	9211812.00
descripción	asa de arco L 230mm H 65mm distancia de sujeción 180mm para horno acero inoxidable		
Para modelos:	V70120TPPCFG2, V90120TPPCFG2, VS70120CFG, VS70120CFGE, VS70120TPFG, VS7080CFE, VS7080CFEQ, VS7080CFG, VS7080CFGE, VS7080CFVE, VS7080TPFE, VS7080TPPCFG, VS90120CFG, VS90120CFGE, VS90120TPFG, VS90160CFG, VS90160CFGE, VS9080CFES, VS9080CFG, VS9080CFGE, VS9080CFVE, VS9080TPFE, VS9080TPFG, VS9080TPPCFG		



1

código	502297	referencia	9211711.00
descripción	asa de arco L 230mm H 65mm distancia de sujeción 180mm para horno derecho acero inoxidable		
Para modelos:	V70120TPPCFG2, VS70120B, VS70120CFG, VS70120CFGE, VS70120TPFG, VS7040GRACQE, VS7040GRACQG, VS7080B, VS7080CPES, VS7080CPGS, VS7080FRE10, VS7080FRE17X, VS7080FRG17VL, VS7080FRGS13, VS7080GRACQE, VS7080GRACQG, VS7080GRL, VS7080TPFG, VS90120B, VS90120CFG, VS90120CFGE, VS90120PCGP, VS90120TPFG, VS9040GRACQE, VS9040GRACQG, VS9080B, VS9080CPES, VS9080CPGS, VS9080FRE15, VS9080FRE17, VS9080FRE21, VS9080FRG17VL, VS9080FRG21VL, VS9080FRGS13, VS9080FRGS20, VS9080GRACQE, VS9080GRACQG, VS9080GRL, VS9080PCGP		



1

código	692802	referencia	256.459.00
descripción	asa de arco L 245mm distancia de sujeción 224mm rosca M6 para sartén basculante ø 20mm con chapa de sujeción plata		
Para modelos:	VS7080BREI, VS7080BREIM, VS7080BRGI, VS7080BRGIM, VS9080BREI, VS9080BREIM, VS9080BRGI, VS9080BRGIM		

cierres

cierres angulares

cierres de palanca

otros



1

código	694003	referencia	B00KI102	
descripción	cierre de palanca L 137mm distancia de sujeción 118mm con cierre aparatos de refrigeración I-01 H 31.5mm An 28mm tipo I-01 longitud total 190mm material de asidero plástico			
Para modelos:	BMA0008-F, BMA0010-F, PB9RI-F			
accesorios para	694003			
	código	700078	referencia	—
	retén L 47mm An 14mm H 29mm distancia de sujeción 21-33mm cinc presofundido ajustable			

cierres de pestillo espagnolette

universal



código	700771	referencia	12024673
descripción	mecanismo de cierre abertura izquierda soporte de eje ø 8x8mm L 170mm An 40mm H 40mm		
Para modelos:	AIC0043-F, AIC0044-F, AIC0045-F, AIC0046-F, AIC0074-F, AIC0075-F, AIC0079-F, AIC0080-F		



bisagras

bisagras de resorte

específico del fabricante



CORECO



código	690763	referencia	12038130
descripción	bisagra a resorte derecho/izquierdo L 111mm An 75mm refrigerador distancia de sujeción 25mm		
Para modelos:	BKZ0008-F, BKZ0022-F, BKZ0023-F		
accesorios para	690763		
	código	691738	referencia —
	bisagra L 100mm An 48mm pos. de montaje izquierdo espesor 5mm para puerta para mesas frías		
	código	701161	referencia —
	soporte de bisagra pos. de montaje abajo derecha L 100mm An 48mm H 17mm alojamiento del eje 8x8mm		



FAGOR



código	690763	referencia	12038130
descripción	bisagra a resorte derecho/izquierdo L 111mm An 75mm refrigerador distancia de sujeción 25mm		
Para modelos:	BKZ0008-F, BKZ0022-F, BKZ0023-F		
accesorios para	690763		
	código	691738	referencia —
	bisagra L 100mm An 48mm pos. de montaje izquierdo espesor 5mm para puerta para mesas frías		
	código	701161	referencia —
	soporte de bisagra pos. de montaje abajo derecha L 100mm An 48mm H 17mm alojamiento del eje 8x8mm		

FRENOX







código	701416	referencia	B02ME100
descripción	bisagra a resorte izquierdo/derecho L 114mm An 75mm distancia de sujeción 25mm latón apto para FRENOX		
Para modelos:	BMA0021-F, BMA0022-F, BMA0024-F, BMA0025-F, BMA0026-F, BMA0027-F, BMA0028-F, BMA0029-F, BMA0032-F, BMA0035-F, BMA0036-F, BMB0028-F, BMB0029-F, BMB0030-F, BMB0033-F, BMB0034-F, BMB0035-F, BMB0036-F, BMB0037-F, BMC0012-F, BMC0014-F, BMC0015-F, BMC0016-F, BNA0036-F, BNA0037-F, BNA0045-F, BNA0052-F, BNA0053-F, BNA0054-F, BNA0055-F, BNA0057-F, BNA0064-F, BNA0065-F, BNA0066-F, BNB0010-F, BNB0011-F, BNB0012-F, BNB0013-F, BNB0014-F, BNB0015-F, BNZ0007-F, CCZ0036-F, CCZ0037-F, VTGB4A-F		
accesorios para	701416		
	código	701388	referencia B02ME102
	casquillo tipo para bisagra de puerta batiente pos. de montaje arriba ø ext. 31mm H 19mm plástico alojamiento del eje 14.3mm		
	código	701653	referencia P30090008
	soporte para bisagra L 180mm An 31mm abajo distancia de sujeción 58mm		





código	701651	referencia	B02ME101
descripción	casquillo para bisagra de puerta batiente 8 ø ext. 11mm 19.5 H 11.5mm UE 5 pzs		
Para modelos:	BMA0021-F, BMA0022-F, BMA0024-F, BMA0025-F, BMA0026-F, BMA0027-F, BMA0028-F, BMA0029-F, BMA0032-F, BMA0035-F, BMA0036-F, BMB0028-F, BMB0029-F, BMB0030-F, BMB0033-F, BMB0034-F, BMB0035-F, BMB0036-F, BMB0037-F, BMC0012-F, BMC0014-F, BMC0015-F, BMC0016-F		



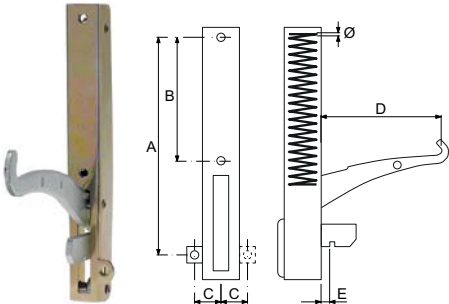

código	701388	referencia	B02ME102
descripción	casquillo tipo para bisagra de puerta batiente pos. de montaje arriba ø ext. 31mm H 19mm plástico alojamiento del eje 14.3mm		
Para modelos:	BMA0021-F, BMA0022-F, BMA0024-F, BMA0025-F, BMA0026-F, BMA0027-F, BMA0028-F, BMA0029-F, BMA0032-F, BMA0035-F, BMA0036-F, BMB0028-F, BMB0029-F, BMB0030-F, BMB0033-F, BMB0034-F, BMB0035-F, BMB0036-F, BMB0037-F, BMC0012-F, BMC0014-F, BMC0015-F, BMC0016-F		
accesorios para	701388		
	código	701416	referencia B02ME100
	bisagra a resorte izquierdo/derecho L 114mm An 75mm distancia de sujeción 25mm latón apto para FRENOX		
	código	701655	referencia —
	casquillo arriba para bisagra de puerta batiente int.ø 10mm ø ext. 14mm L 36mm para aluminio		

			
1			
código	701653	referencia	P30090008
descripción	soporte para bisagra L 180mm An 31mm abajo distancia de sujeción 58mm		
Para modelos:	BMA0021-F, BMA0022-F, BMA0024-F, BMA0025-F, BMA0026-F, BMA0027-F, BMA0028-F, BMA0029-F, BMA0032-F, BMA0035-F, BMA0036-F, BMB0028-F, BMB0029-F, BMB0030-F, BMB0033-F, BMB0034-F, BMB0035-F, BMB0036-F, BMB0037-F, BMC0012-F, BMC0014-F, BMC0015-F, BMC0016-F		
accesorios para	701653		
		código	701416 referencia B02ME100
	bisagra a resorte izquierdo/derecho L 114mm An 75mm distancia de sujeción 25mm latón apto para FRENOX		

bisagras para hornos

			
1			
código	700007	referencia	684.026.00
descripción	bisagra para horno distancia de sujeción 173mm distancia de sujeción 2 105mm orejas de fijación 14mm longitud de palanca 120mm distancia de ranura 11mm espesor de resorte 3.5mm posición fijación derecho longitud muelle 112mm An 25mm		
Para modelos:	VS70120CFGG, VS90120CFGG		
accesorios para	700007		
		código	700001 referencia 684.011.00
	contrasoporte L 118mm An 17mm distancia de sujeción 94mm		
		código	700006 referencia 684.027.00
	bisagra para horno distancia de sujeción 173mm distancia de sujeción 2 105mm orejas de fijación 14mm longitud de palanca 120mm distancia de ranura 11mm espesor de resorte 3.5mm posición fijación izquierdo longitud muelle 112mm An 25mm		

			
1			
código	700006	referencia	684.027.00
descripción	bisagra para horno distancia de sujeción 173mm distancia de sujeción 2 105mm orejas de fijación 14mm longitud de palanca 120mm distancia de ranura 11mm espesor de resorte 3.5mm posición fijación izquierdo longitud muelle 112mm An 25mm		
Para modelos:	VS70120CFGG, VS90120CFGG		
accesorios para	700006		
		código	700001 referencia 684.011.00
	contrasoporte L 118mm An 17mm distancia de sujeción 94mm		

accesorios para	700006		
		código	700007 referencia 684.026.00
	bisagra para horno distancia de sujeción 173mm distancia de sujeción 2 105mm orejas de fijación 14mm longitud de palanca 120mm distancia de ranura 11mm espesor de resorte 3.5mm posición fijación derecho longitud muelle 112mm An 25mm		

			
1			
código	701621	referencia	684.030.00
descripción	bisagra para horno distancia de sujeción 173mm orejas de fijación 14mm longitud de palanca 115mm distancia de ranura 7mm espesor de resorte 3.8mm posición fijación izquierdo/derecho longitud muelle 110mm L 207mm An 25mm		
Para modelos:	V70120TPPCFG2, V90120TPPCFG2, VS70120CFG, VS70120CFGE, VS70120TPFG, VS7080CFE, VS7080CFEQ, VS7080CFG, VS7080CFGE, VS7080CFVE, VS7080TPFE, VS7080TPFG, VS7080TPPCFG, VS90120CFG, VS90120CFGE, VS90120TPFG, VS90160CFG, VS90160CFGE, VS9080CFES, VS9080CFG, VS9080CFGE, VS9080CFVE, VS9080TPFE, VS9080TPPCFG		

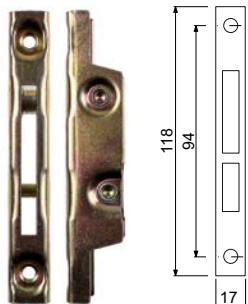
			
1			
código	700001	referencia	684.011.00
descripción	contrasoporte L 118mm An 17mm distancia de sujeción 94mm		
Para modelos:	V70120TPPCFG2, V90120TPPCFG2, VS70120CFG, VS70120CFGE, VS70120CFGG, VS70120TPFG, VS7080CFE, VS7080CFEQ, VS7080CFG, VS7080CFGE, VS7080CFVE, VS7080TPFE, VS7080TPFG, VS7080TPPCFG, VS90120CFG, VS90120CFGE, VS90120CFGG, VS90120TPFG, VS90160CFG, VS90160CFGE, VS9080CFES, VS9080CFG, VS9080CFGE, VS9080CFVE, VS9080TPFE, VS9080TPFG, VS9080TPPCFG		

soporte de puerta

			
1			
código	692904	referencia	12039311
descripción	bisagra L 54mm An 32mm H 10mm pos. de montaje abajo rosca M6 int.ø 15.5mm		
Para modelos:	AIC0037-F, AIC0038-F, AIC0039-F, AIC0040-F, AIC0041-F, AIC0042-F, AIC0043-F, AIC0044-F, AIC0045-F, AIC0046-F, AIC0071-F, AIC0072-F, AIC0073-F, AIC0074-F, AIC0075-F, AIC0076-F, AIC0077-F, AIC0078-F, AIC0079-F, AIC0080-F		



			
1			
código	692903	referencia	12047967
descripción	bisagra L 54mm An 32mm H 12.5mm pos. de montaje abajo rosca M6 int.ø 15.5mm		
Para modelos:	AIC0037-F, AIC0038-F, AIC0039-F, AIC0040-F, AIC0041-F, AIC0042-F, AIC0043-F, AIC0044-F, AIC0045-F, AIC0046-F, AIC0071-F, AIC0072-F, AIC0073-F, AIC0074-F, AIC0075-F, AIC0076-F, AIC0077-F, AIC0078-F, AIC0079-F, AIC0080-F		

			
1			
código	701461	referencia	P30037072
descripción	bisagra L 56mm An 39mm juego		
Para modelos:	CCZ0036-F, CCZ0037-F		

			
1			
código	690764	referencia	12037723
descripción	casquillo An 23.5mm H 53.5mm pos. de montaje arriba/abajo ø 16mm int.ø 10mm gris para bisagra		
Para modelos:	BKZ0008-F, BKZ0022-F, BKZ0023-F		
accesorios para	690764		
	código	referencia	12038076
	 perno de bisagra arriba ø 10mm L 30mm H M6 para mesas frías pos. de montaje arriba		

			
1			
código	521285	referencia	12039312
descripción	cojinete giratorio L 152mm An 29mm H 8.5mm pos. de montaje arriba sin perno		
Para modelos:	AIC0037-F, AIC0038-F, AIC0039-F, AIC0040-F, AIC0041-F, AIC0042-F, AIC0043-F, AIC0044-F, AIC0045-F, AIC0046-F, AIC0071-F, AIC0072-F, AIC0073-F, AIC0074-F, AIC0075-F, AIC0076-F, AIC0077-F, AIC0078-F, AIC0079-F, AIC0080-F		

			
1			
código	691089	referencia	12023636
descripción	pasador de bisagra		
Para modelos:	AIC0037-F, AIC0038-F, AIC0039-F, AIC0040-F, AIC0041-F, AIC0042-F, AIC0043-F, AIC0044-F, AIC0045-F, AIC0046-F, AIC0071-F, AIC0072-F, AIC0073-F, AIC0074-F, AIC0075-F, AIC0076-F, AIC0077-F, AIC0078-F, AIC0079-F, AIC0080-F		

accesorios

ejes

			
1			
código	700817	referencia	12038076
descripción	perno de bisagra arriba ø 10mm L 30mm H M6 para mesas frías pos. de montaje arriba		
Para modelos:	BKZ0008-F, BKZ0022-F, BKZ0023-F		

elementos extraíbles

guías telescópicas

			
1			
código	692488	referencia	A00CK100
descripción	guía de extracción UE 2 pzs L 550mm long.extracción 400mm An 60mm H 20mm		
Para modelos:	BNA0030-F, BNA0031-F, BNA0036-F, BNA0037-F, BNA0044-F, BNA0045-F, BNA0052-F, BNA0053-F, BNA0054-F, BNA0055-F, BNA0056-F, BNA0057-F, BNB0010-F, BNB0011-F, BNB0012-F, BNB0013-F, BNB0014-F, BNB0015-F, CCZ0036-F, CCZ0037-F, VTGB2A-F, VTGB2-F, VTGB3A-F, VTGB3-F, VTGB4A-F, VTGB4-F		

grifería para cocinas industriales

aireadores y purgadores

			
1			
código	542408	referencia	256.334.00
descripción	aireador/purgador rosca 3/8" M EC 24 cromado con adaptador para marmita L 37mm		
Para modelos:	VS7080PEI50, VS7080PGI50, VS9080PEI150, VS9080PGI150		
repuestos para	542408		
	código	referencia	—
	 aireador/purgador rosca 3/8" M EC 24 cromado L 37mm		



bisagras de tapa

MODULAR

bisagras de tapa



1

código	514520	referencia	6111636.00
descripción	bisagra de tapa L 250mm int.ø 40mm ø ext. 42mm radio de tapa 215mm		
Para modelos:	VS7080PEI50, VS7080PG50, VS7080PGI50		

piezas de repuesto



1

código	692797	referencia	941.138.00
descripción	casquillo para marmita ø 39mm L 55mm		
Para modelos:	VS7080PEI50, VS7080PG50, VS7080PGI50, VS9080PEI150, VS9080PGI150		



1

código	692783	referencia	941.139.15
descripción	cojinete de ajuste para marmita ø 40/20mm L 80mm		
Para modelos:	VS7080PEI50, VS7080PG50, VS7080PGI50		

grifos de vaciado

latón

grifos de vaciado



1

código	541672	referencia	678.086.00
descripción	grifo de vaciado 1 1/2" H cierre cónico A 85mm B1 58mm B2 126mm		
Para modelos:	VS7080PEI50, VS7080PG50, VS7080PGI50		

repuestos para 541672

	código	540213	referencia	—
	manilla int.ø 5mm L 117mm			
	código	540956	referencia	—
	junta para grifo de vaciado ø tubo 46mm int.ø 38mm H 2mm			

accesorios para 541672

	código	510404	referencia	953.031.00
	junta plana fibra ø ext. 44mm int.ø 34mm espesor 2mm UE 1 pzs			
	código	890116	referencia	—
	grasa para grifería FERMIT GLISSA tubo 60g -20 a +140°C homologación corresponde a la recomendación KTW			
	código	890118	referencia	—
	grasa para grifería FERMIT GLISSA toma 1000g -20 a +140°C homologación corresponde a la recomendación KTW			
	código	890119	referencia	—
	grasa para grifería FERMIT GLISSA tubo 30g -20 a +140°C homologación corresponde a la recomendación KTW			



1

código	540275	referencia	678.051.00
descripción	grifo de vaciado 2" H con tuerca de racor A 90mm B 151mm B1 80mm latón cromado		
Para modelos:	VS9080PEI150, VS9080PGI150		

repuestos para 540275

	código	540214	referencia	—
	manilla int.ø 6mm L 145mm			

accesorios para 540275

	código	529484	referencia	953.030.00
	junta plana fibra ø ext. 58mm int.ø 50mm espesor 2mm UE 1 pzs			

Continúa en la página siguiente



accesorios para	540275		
	código	542448	referencia
			—
		junta silicona 60x49x2 para grifo de vaciado 2"	

grifos de prueba

grifos de prueba



1			
código	542396	referencia	678.079.00
descripción	grifo de prueba rosca 3/8" H An 78mm B1 22mm ø cabezal 45mm espesor cabezal 18mm		
Para modelos:	VS7080PEI50, VS7080PGI50, VS9080PEI150, VS9080PGI150		

válvulas de seguridad



1			
código	514121	referencia	678.049.00
descripción	válvula de seguridad presión de intervención 0.5bar con homologación CE M88 rosca 1 1/4"		
Para modelos:	VS7080PEI50, VS7080PGI50, VS9080PEI150, VS9080PGI150		

filtros

filtros de grasa

filtros de grasa



1			
código	970962	referencia	643.007.00
descripción	filtro de grasa An 270mm L 270mm espesor 12mm para aparato de inducción		
Para modelos:	VS9040INDT, VS9040INDWT, VS9080INDT		

pies para aparatos y tapas terminales

pies para aparatos

con fijación atornillada

universal



1			
código	700868	referencia	73100
descripción	pie de aparato tubo ø 64mm rosca M12 rosca L 25mm H 155-235mm inox medida 2 1/2" UE 1 pzs		
Para modelos:	GLB0047		



1			
código	513287	referencia	926117
descripción	pie de aparato tubo ø 60mm rosca M12 rosca L 33mm H 155-235mm inox medida 2" UE 1 pzs		
Para modelos:	GLB0045, GLB0047, GLB0048, GLB0049, GLB0050, GLB0051		

con placa de sujeción



1			
código	701616	referencia	912.090.14
descripción	pie de aparato tubo ø 64mm dimensiones de la placa 74x74mm dist. del agujero 56x56mm H 130-190mm inox medida 2" UE 1 pzs		
Para modelos:	V70120TPPCFG2, V90120TPPCFG2, VS70120B, VS70120CFG, VS70120CFGE, VS70120CFGG, VS70120TPFG, VS7040B, VS7040CPES, VS7040CPGS, VS7040FRE10, VS7040FRE17X, VS7040FRE88, VS7040FRG17VL, VS7040FRGS13, VS7040GRACQE, VS7040GRACQG, VS7040GRL, VS7080B, VS7080BREI, VS7080BREIM, VS7080BRGI, VS7080BRGIM, VS7080CFE, VS7080CFEQ, VS7080CFG, VS7080CFGE, VS7080CFVE, VS7080CPES, VS7080CPGS, VS7080FRE10, VS7080FRE17X, VS7080FRG17VL, VS7080FRGS13, VS7080GRACQE, VS7080GRACQG, VS7080GRL, VS7080PEI50, VS7080PG50, VS7080PGI50, VS7080TPFE, VS7080TPFG, VS7080TPPCFG, VS90120B, VS90120CFG, VS90120CFGE, VS90120CFGG, VS90120PCGP, VS90120TPFG, VS90160CFG...(Otros modelos se puede ver en la tienda web)		

			
código	701100	referencia	12009104 12033566
descripción	pie de aparato tubo ø 64mm dimensiones de la placa 82x82mm dist. del agujero 65x65mm H 135-200mm inox medida 2 1/2" UE 1 pzs		
Para modelos:	AIC0037-F, AIC0038-F, AIC0039-F, AIC0040-F, AIC0041-F, AIC0042-F, AIC0071-F, AIC0072-F, AIC0073-F, AIC0076-F, AIC0077-F, AIC0078-F, BKZ0008-F, BKZ0023-F, GLB0071-F, GLB0080, GLB0082		

			
código	701007	referencia	B00AY100
descripción	pie de aparato tubo ø 64mm dimensiones de la placa 82x82mm dist. del agujero 68x68mm H 100-150mm inox medida 2 1/2" UE 1 pzs		
Para modelos:	BMA0021-F, BMA0022-F, BMA0024-F, BMA0025-F, BMA0026-F, BMA0027-F, BMA0028-F, BMA0029-F, BMA0032-F, BMA0035-F, BMA0036-F, BMB0028-F, BMB0029-F, BMB0030-F, BMB0033-F, BMB0034-F, BMB0035-F, BMB0036-F, BMB0037-F, BMC0012-F, BMC0014-F, BMC0015-F, BMC0016-F, BNA0030-F, BNA0031-F, BNA0036-F, BNA0037-F, BNA0044-F, BNA0045-F, BNA0052-F, BNA0053-F, BNA0054-F, BNA0055-F, BNA0056-F, BNA0057-F, BNA0064-F, BNA0065-F, BNA0066-F, BNB0010-F, BNB0011-F, BNB0012-F, BNB0013-F, BNB0014-F, BNB0015-F, BNZ0001-F, BNZ0002-F, BNZ0003-F, BNZ0004-F, BNZ0005-F, BNZ0006-F...(Otros modelos se puede ver en la tienda web)		

pies enroscables

			
código	510115	referencia	12024163
descripción	pie de aparato rosca M10 rosca L 40mm ø 30mm H 10mm UE 1 pzs		
Para modelos:	GLB0067-F, GLB0069-F, GLB0081		

			
código	692781	referencia	951.083.00
descripción	pie de aparato rosca M8 rosca L 54mm ø 25mm H 11mm UE 1 pzs		
Para modelos:	V080FTREVCRT, V70120TPPCG2T, V7040FTREVCRT, V9040FTREVCRT, V9080FTREVCRT, VS7040FTEVCRT, VS7040FTEVT, VS7040FTREVT, VS7080FTEVCRT, VS7080FTEVT, VS7080FTREVT, VS7080FTRREVC, VS7080FTRREVT, VS7080TPGT, VS7080TPPCGT, VS9040FTEVCRT, VS9040FTEVT, VS9040FTREVT, VS9080FTEVCRT, VS9080FTEVT, VS9080FTREVC, VS9080FTRREVT		

TENTE

con placa de sujeción

acero cromado

			
código	700213 ¹	referencia	B00AY102
descripción	rueda pivotante con freno total ø 100mm placa de sujeción carcasa chapa de acero tincado dimensiones de la placa 105x85mm dist. del agujero 60x78mm capacidad 80kg cojinete cojinete de fricción cuerpo de rueda polipropileno superficie fricción neumáticos TPE H 128mm ancho de rueda 32mm UE 1 pzs		
Para modelos:	BMA0029-F, BMB0030-F, BMB0035-F, BMB0036-F, BMB0037-F, BMC0012-F, BMC0014-F, BMC0016-F, BNA0036-F, BNA0037-F, BNA0045-F, BNA0052-F, BNA0053-F, BNA0054-F, BNA0055-F, BNA0057-F, BNA0064-F, BNA0065-F, BNA0066-F, BNB0010-F, BNB0011-F, BNB0012-F, BNB0013-F, BNB0014-F, BNB0015-F, BNZ0007-F, CCZ0036-F, CCZ0037-F, VTGB4A-F		

¹con freno total

			
código	700214	referencia	B00AY101
descripción	rueda pivotante ø 100mm placa de sujeción carcasa chapa de acero tincado dimensiones de la placa 105x85mm dist. del agujero 60x78mm capacidad 80kg cojinete cojinete de fricción cuerpo de rueda polipropileno superficie fricción neumáticos TPE H 128mm ancho de rueda 32mm		
Para modelos:	BMA0021-F, BMA0022-F, BMA0024-F, BMA0025-F, BMA0026-F, BMA0027-F, BMA0028-F, BMA0029-F, BMA0032-F, BMA0035-F, BMA0036-F, BMB0028-F, BMB0029-F, BMB0030-F, BMB0033-F, BMB0034-F, BMB0035-F, BMB0036-F, BMB0037-F, BMC0012-F, BMC0014-F, BMC0015-F, BMC0016-F, BNA0030-F, BNA0031-F, BNA0036-F, BNA0037-F, BNA0044-F, BNA0045-F, BNA0052-F, BNA0053-F, BNA0054-F, BNA0055-F, BNA0056-F, BNA0057-F, BNA0064-F, BNA0065-F, BNA0066-F, BNB0010-F, BNB0011-F, BNB0012-F, BNB0013-F, BNB0014-F, BNB0015-F, BNZ0001-F, BNZ0002-F, BNZ0003-F, BNZ0004-F, BNZ0005-F, BNZ0006-F...(Otros modelos se puede ver en la tienda web)		

cestos

tamices para empanar

			
código	970965	referencia	983.048.00
descripción	tamiz para empanar L 332mm An 297mm H 100mm acero cromado para grill		
Para modelos:	VS7040FRE17X, VS7040FRG17VL, VS7080FRE17X, VS7080FRG17VL, VS9040FRG17VL, VS9080FRE17, VS9080FRG17VL		

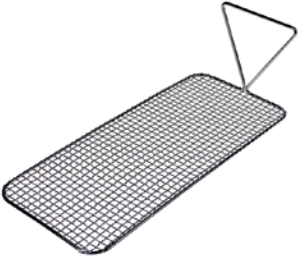

1

código	970632	referencia	683.095.00
descripción	tamiz para empanar L 338mm An 134mm H 100mm		
Para modelos:	VS7040FRE88, VS9040FRE88		



1

código	970983	referencia	683.096.00
descripción	tamiz para empanar L 339mm An 220mm H 100mm acero cromado apto para para freidora 13 L		
Para modelos:	VS7040FRGS13, VS7080FRGS13, VS9040FRE17, VS9040FRGS13, VS9080FRGS13		



1

código	970964	referencia	983.045.00
descripción	tamiz para empanar L 430mm An 297mm H 110mm		
Para modelos:	VS7040FRE17X, VS7080FRE17X, VS9040FRE17, VS9040FRE21, VS9040FRG21VL, VS9040FRGS20, VS9080FRE17, VS9080FRE21, VS9080FRG21VL, VS9080FRGS20		



1

código	970545	referencia	683.001.23
descripción	tamiz para empanar L 330mm An 235mm apto para freidora		
Para modelos:	VS7040FRE10, VS7080FRE10		

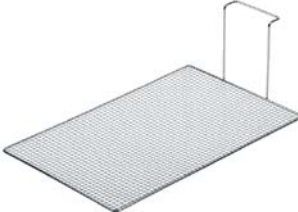

1

código	970963	referencia	983.010.00
descripción	tamiz para empanar L 410mm An 260mm H 140mm para freidora		
Para modelos:	VS9040FRE15, VS9080FRE15		

cestos de lavado

accesorios

esquinas deslizantes



1

código	970820	referencia	75075
descripción	esquina deslizante L 44mm An 44mm H 17mm		
Para modelos:	GLB0045, GLB0047, GLB0048, GLB0049, GLB0050, GLB0051		

rejillas y rieles guía

rejillas



1

código	211099	referencia	611.937.00
descripción	rejilla L 440mm An 325mm H 20mm acero inoxidable para grill de piedra volcánica		
Para modelos:	VS7040GRL, VS7080GRL		

parrillas

universal

sin reborde



1

código	970834	referencia	B01RF100
descripción	parrilla An 330mm P 530mm H 10mm acero plastificado anillo externo reforzado 6.9mm refuerzos longitudinales 3.5mm traviesas 1 gris		
Para modelos:	BNA0030-F, BNA0031-F, BNA0036-F, BNA0037-F, BNA0044-F, BNA0045-F, BNA0052-F, BNA0053-F, BNA0054-F, BNA0055-F, BNA0056-F, BNA0057-F, BNB0010-F, BNB0011-F, BNB0012-F, BNB0013-F, BNB0014-F, BNB0015-F, VTGB2A-F, VTGB2-F, VTGB3A-F, VTGB3-F, VTGB4A-F, VTGB4-F		



código	970835	referencia	B01RF115
descripción	parrilla An 600mm P 400mm H 12mm acero plastificado anillo externo reforzado 7.5mm refuerzos longitudinales 5.5mm traviesas 1 gris		
Para modelos:	BNZ0001-F, BNZ0002-F, BNZ0003-F, BNZ0004-F, BNZ0005-F, BNZ0006-F, BNZ0007-F, BNZ0008-F, CCZ0036-F, CCZ0037-F		

con reborde



código	970833	referencia	B01RF102
descripción	parrilla An 530mm P 650mm GN 2/1 H 29.5mm acero plastificado anillo externo reforzado 8mm refuerzos longitudinales 3.5mm traviesas 2 gris		
Para modelos:	BMA0021-F, BMA0022-F, BMA0024-F, BMA0025-F, BMA0032-F, BMA0035-F, BMB0028-F, BMB0029-F, BMB0030-F, BMB0033-F, BMB0035-F, BMC0012-F, BMC0014-F, BMC0015-F, BMC0016-F		

rejillas para chimeneas



código	692770	referencia	982.024.00
descripción	rejilla de chimenea L 400mm An 80mm hierro fundido		
Para modelos:	V080FTREVCRT, V70120TPPCFG2, V70120TPPCG2T, V7040FTREVCRT, V7040FTRGVCRT, V7080FTRGVCRT, V90120TPPCFG2, V90120TPPCG2T, V9040FTREVCRT, V9040FTRGVCRT, V9080FTREVCRT, V9080FTRGVCRT, V9080FTRRECRT, V9080FTRRGRT, VS70120CFG, VS70120CFGE, VS70120CFGG, VS70120PCGT, VS70120TPFG, VS7040BMET, VS7040BMFEP, VS7040BMGT, VS7040CPGS, VS7040FRE17X, VS7040FRE88, VS7040FRG17VL, VS7040FRGS13, VS7040FTET, VS7040FTEVCRT, VS7040FTEVT, VS7040FTGT, VS7040FTGVCRT, VS7040FTGVT, VS7040FTRET, VS7040FTREVT, VS7040FTRGT, VS7040FTRGVT, VS7040GRACQE, VS7040GRACQG, VS7040GRL, VS7040PCEQT, VS7040PCET, VS7040PCGT, VS7080BMET, VS7080BMFEP, VS7080BMGT, VS7080BREI, VS7080BREIM, VS7080BRGI, VS7080BRGIM... (Otros modelos se puede ver en la tienda web)		

portarejillas



código	694963	referencia	622.967.00
descripción	portarrejillas L 630mm H 175mm pos. de montaje izquierdo/derecho An 40mm distancia de sujeción 603mm		
Para modelos:	V70120TPPCFG2, V90120TPPCFG2, VS70120CFG, VS70120CFGE, VS70120TPFG, VS7080CFE, VS7080CFEQ, VS7080CFG, VS7080CFGE, VS7080CFVE, VS7080TPFE, VS7080TPFG, VS7080TPPCFG, VS90120CFG, VS90120CFGE, VS90120TPFG, VS90160CFG, VS90160CFGE, VS9080CFES, VS9080CFG, VS9080CFGE, VS9080CFVE, VS9080TPFE, VS9080TPFG, VS9080TPPCFG		
accesorios para	694963		
	código	701650	referencia —
	perno para portarrejillas L 18mm ø cabezal 15mm M6		



código	692890	referencia	9111317.00
descripción	portarrejillas L 630mm H 190mm pos. de montaje izquierdo/derecho An 50mm distancia de sujeción 608mm		
Para modelos:	VS70120CFGG, VS90120CFGG		

rieles guía y soportos

específico del fabricante

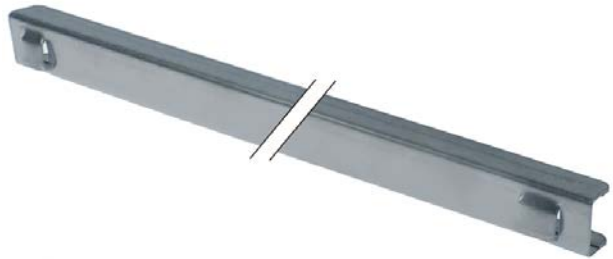

código	701329	referencia	P11070025
descripción	guida forma U L 630mm An 19mm pos. de montaje izquierdo/derecho anchura de gancho 13mm altura interior 15mm		
Para modelos:	BMA0021-F, BMA0022-F, BMA0024-F, BMA0025-F, BMA0032-F, BMA0035-F, BMB0028-F, BMB0029-F, BMB0030-F, BMB0033-F, BMB0035-F, BMC0012-F, BMC0014-F, BMC0015-F, BMC0016-F		

juntas

juntas para frigoríficos

juntas insertables

perfil 9198

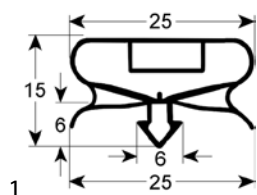

código	901737	referencia	A00CO107
descripción	junta para frigorífico perfil 9198 An 493mm L 618mm medida inserción		
Para modelos:	BNZ0001-F, BNZ0002-F, BNZ0003-F, BNZ0004-F, BNZ0005-F, BNZ0006-F, BNZ0007-F, BNZ0008-F, CCZ0036-F, CCZ0037-F		

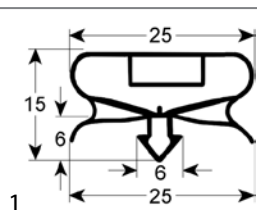

código	901736	referencia	A00CO101
descripción	junta para frigorífico perfil 9198 An 610mm L 405mm medida inserción FRENEX		
Para modelos:	BNA0030-F, BNA0031-F, BNA0036-F, BNA0037-F, BNA0044-F, BNA0045-F, BNA0052-F, BNA0053-F, BNA0054-F, BNA0055-F, BNA0056-F, BNA0057-F, BNA0064-F, BNA0065-F, BNA0066-F, BNB0010-F, BNB0011-F, BNB0012-F, BNB0013-F, BNB0014-F, BNB0015-F, CCZ0036-F, CCZ0037-F, VTGB2A-F, VTGB2-F, VTGB3A-F, VTGB3-F, VTGB4A-F, VTGB4-F		

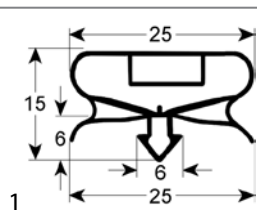

código	901724	referencia	A00CO119
descripción	junta para frigorífico perfil 9198 An 620mm L 1540mm medida inserción		
Para modelos:	BMA0008-F, BMA0010-F, BMA0021-F, BMA0022-F, BMA0024-F, BMA0025-F, BMA0026-F, BMA0027-F, BMA0028-F, BMA0032-F, BMA0035-F, BMA0036-F, BMB0028-F, BMB0029-F, BMB0033-F, BMB0034-F, BMB0035-F, BMB0036-F, BMB0037-F, BMC0014-F, BMC0015-F, BMC0016-F, PB9RI-F		

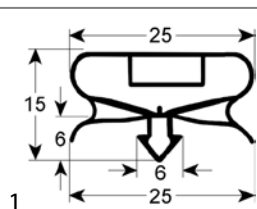

código	901735	referencia	A00CO118
descripción	junta para frigorífico perfil 9198 An 620mm L 730mm medida inserción		
Para modelos:	BMB0030-F, BMC0012-F, BMC0016-F		

juntas térmicas

juntas para puertas

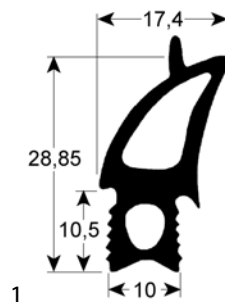

código	902197	referencia	12041578
descripción	junta de puerta perfil 2730 An 675mm L 775mm		
Para modelos:	AIC0041-F, AIC0042-F, AIC0073-F, AIC0078-F		

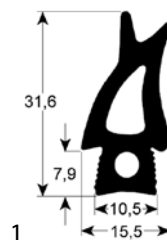

código	902480	referencia	12039475
descripción	junta de puerta perfil 2732 An 460mm L 770mm medida inserción exterior para horno a vapor combinado para FAGOR		
Para modelos:	AIC0039-F, AIC0040-F, AIC0072-F, AIC0077-F		

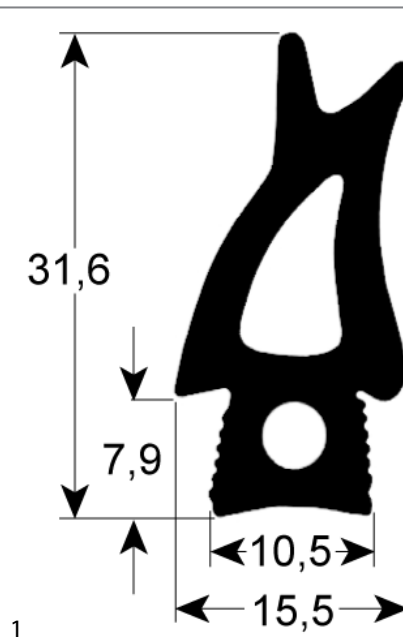

código	902555	referencia	12041134
descripción	junta de puerta perfil 2732 An 470mm L 1150mm medida inserción exterior UE 1 para FAGOR		
Para modelos:	AIC0043-F, AIC0044-F, AIC0074-F, AIC0079-F		

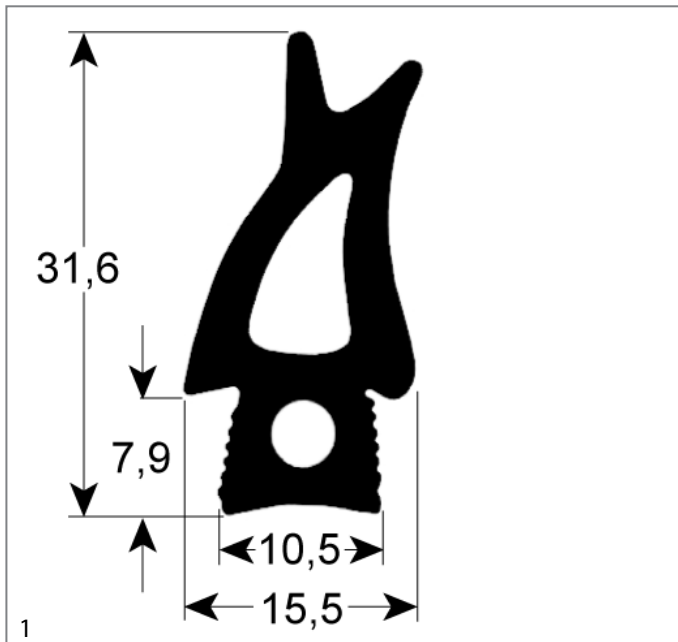

código	902554	referencia	12039599
descripción	junta de puerta perfil 2732 An 470mm L 500mm UE 1 para modelo medida inserción exterior para FAGOR		
Para modelos:	AIC0037-F, AIC0038-F, AIC0071-F, AIC0076-F		



código	902483	referencia	FO4NEA0039
descripción	junta de puerta perfil 2763 L 1800mm para TECNODOM		

juntas para bandejeros

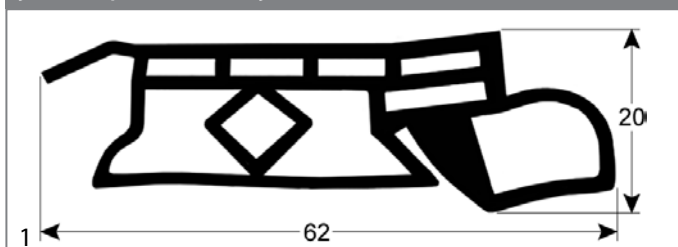

código	902553	referencia	12041088
descripción	junta para carro porta bandejas perfil 4160 L 510mm apto para FAGOR UE 1		
Para modelos:	AIC0043-F, AIC0044-F, AIC0074-F, AIC0079-F		

juntas tóricas

EPDM

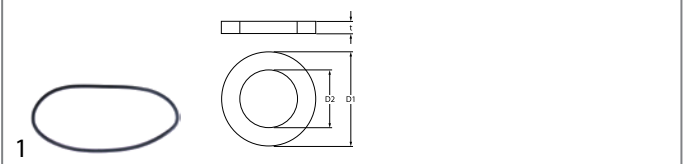

código	510551	referencia	456023 926084
descripción	junta de tapa de bomba int.ø 158.3mm tipo bomba 1214/1293/1225 /2243/1226/1204/3473/1241 espesor 3.53mm EPDM UE 1 pzs		
Para modelos:	GLB0040, GLB0041, GLB0042, GLB0045, GLB0047, GLB0048, GLB0049, GLB0050, GLB0051		

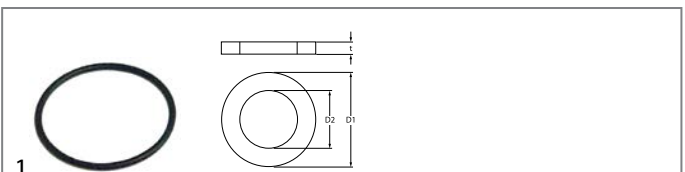

código	532021	referencia	953.018.00
descripción	junta tórica EPDM espesor 1.78mm int.ø 33.05mm UE 10 pzs		
Para modelos:	VS7040FRG17VL, VS7080BRGI, VS7080BRGIM, VS7080FRG17VL, VS7080PG50, VS7080PGI50, VS9040FRG17VL, VS9040FRG21VL, VS9080BRGI, VS9080BRGIM, VS9080FRG17VL, VS9080FRG21VL, VS9080PGI150		

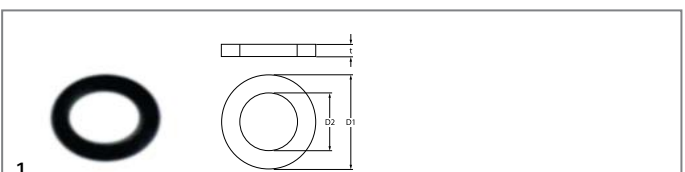

código	528485	referencia	456060
descripción	junta tórica EPDM espesor 1.78mm int.ø 6.07mm UE 1 pzs		
Para modelos:	GLB0041, GLB0042, GLB0043C, GLB0044C		

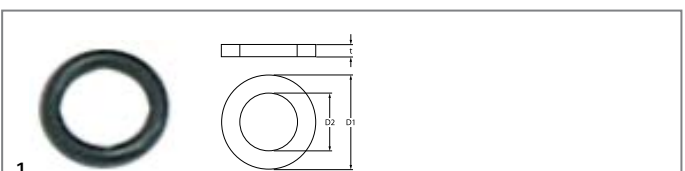

código	510303	referencia	CGR106
descripción	junta tórica EPDM espesor 1.78mm int.ø 6.75mm UE 1 pzs		
Para modelos:	GLB0043C-60Hz		

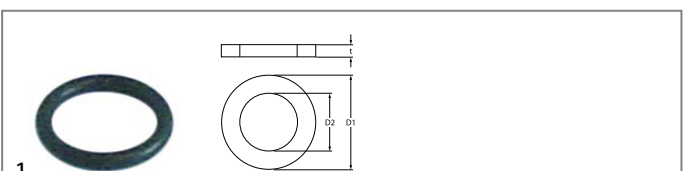

código	504574	referencia	456019
descripción	junta tórica EPDM espesor 1.78mm int.ø 9.25mm UE 1 pzs		
Para modelos:	GLB0043C-60Hz		

código	532103	referencia	12049214
descripción	junta tórica EPDM espesor 3.53mm int.ø 13.87mm UE 10 pzs		
Para modelos:	GLB0071-F, GLB0080		

código	532718	referencia	80816
descripción	junta tórica EPDM espesor 4mm int.ø 80mm UE 1 pzs		
Para modelos:	GLB0040, GLB0041, GLB0042, GLB0044C, GLB0049, GLB0050, GLB0051		

código	511322	referencia	953.025.00
descripción	junta tórica EPDM espesor 3.53mm int.ø 20.22mm UE 1 pzs		
Para modelos:	VS7040BMET, VS7040BMFEP, VS7040BMGT, VS7080BMET, VS7080BMFEP, VS7080BMGT, VS9040BMET, VS9040BMFEP, VS9040BMGT, VS9080BMET, VS9080BMFEP, VS9080BMGT		

código	510408	referencia	456002
descripción	junta tórica EPDM espesor 5.34mm int.ø 47mm UE 1 pzs		
Para modelos:	GLB0040, GLB0041, GLB0042, GLB0043C, GLB0043C-60Hz, GLB0044C		

código	510072	referencia	456016
descripción	junta tórica EPDM espesor 3.53mm int.ø 32.93mm UE 1 pzs		
Para modelos:	GLB0041, GLB0042		

Viton

código	528155	referencia	CGR4131NT
descripción	junta tórica Viton espesor 3.53mm int.ø 32.93mm UE 1 pzs		
Para modelos:	GLB0041, GLB0043C-60Hz, GLB0047		

código	512511	referencia	12115850
descripción	junta tórica EPDM espesor 3.53mm int.ø 32mm UE 10 pzs		
Para modelos:	GLB0067-F, GLB0069-F		

código	510243	referencia	653.018.00
descripción	junta tórica Viton espesor 3.53mm int.ø 55.56mm UE 1 pzs		
Para modelos:	VS7040FRE17X, VS7040FRE88, VS7080FRE17X, VS9040FRE17, VS9040FRE21, VS9040FRE88, VS9080FRE17, VS9080FRE21		

código	532118	referencia	653.017.00
descripción	junta tórica EPDM espesor 3.53mm int.ø 55.56mm UE 10 pzs		
Para modelos:	VS7040FRE17X, VS7040FRE88, VS7080FRE17X, VS9040FRE17, VS9040FRE21, VS9040FRE88, VS9080FRE17, VS9080FRE21		

anillos de junta

juntas de fibra

código	532603	referencia	926252
descripción	junta tórica EPDM espesor 3.53mm int.ø 69.85mm UE 1 pzs		
Para modelos:	GLB0041, GLB0042, GLB0043C, GLB0043C-60Hz, GLB0044C		

código	518541	referencia	437021
descripción	junta plana FIBER ø ext. 12mm int.ø 8mm espesor 1.5mm UE 1 pzs		
Para modelos:	GLB0041, GLB0042, GLB0043C, GLB0044C		

			
1			
código	506241	referencia	CGF17
descripción	junta plana FIBER ø ext. 24mm int.ø 16mm espesor 2mm UE 1 pzs		
Para modelos:	GLB0049, GLB0050, GLB0051		

			
1			
código	510074	referencia	437025
descripción	junta plana FIBER ø ext. 35mm int.ø 27mm espesor 1.5mm UE 1 pzs		
Para modelos:	GLB0040, GLB0041, GLB0042, GLB0043C, GLB0044C		

			
1			
código	510404	referencia	953.031.00
descripción	junta plana fibra ø ext. 44mm int.ø 34mm espesor 2mm UE 1 pzs		
Para modelos:	VS7080PEI50, VS7080PGI50, VS9080PEI150, VS9080PGI150		

			
1			
código	529484	referencia	953.030.00
descripción	junta plana fibra ø ext. 58mm int.ø 50mm espesor 2mm UE 1 pzs		
Para modelos:	VS9080PEI150, VS9080PGI150		

juntas de goma

			
1			
código	518060	referencia	456040
descripción	junta goma ø ext. 132mm int.ø 122mm espesor 5mm		
Para modelos:	GLB0040, GLB0041, GLB0042		

			
1			
código	507544	referencia	75402
descripción	junta plana goma ø ext. 29mm int.ø 17mm espesor 1mm UE 1 pzs		
Para modelos:	GLB0041		

			
1			
código	515018	referencia	12009947
descripción	junta plana goma ø ext. 32mm int.ø 21mm espesor 3mm UE 1 pzs		
Para modelos:	GLB0082		

			
1			
código	518240	referencia	437078
descripción	junta plana goma ø ext. 33mm int.ø 17mm espesor 1.5mm UE 1 pzs		
Para modelos:	GLB0040, GLB0041, GLB0042, GLB0043C, GLB0044C		

			
1			
código	516261	referencia	437098
descripción	junta plana goma ø ext. 33mm int.ø 25mm espesor 2.5mm para cámara de aire UE 1 pzs		
Para modelos:	GLB0043C-60Hz		

			
1			
código	510876	referencia	437104
descripción	junta plana goma ø ext. 45mm int.ø 33mm espesor 3mm UE 1 pzs		
Para modelos:	GLB0043C-60Hz		

			
1			
código	513059	referencia	437063
descripción	junta plana goma ø ext. 52mm int.ø 40mm espesor 3mm UE 1 pzs		
Para modelos:	GLB0049, GLB0050, GLB0051		

			
1			
código	518205	referencia	80182
descripción	junta plana goma ø ext. 61mm int.ø 47mm espesor 2mm UE 1 pzs		
Para modelos:	GLB0040		

juntas de gomaespuma

			
1			
código	505408	referencia	12041815
descripción	junta de gomaespuma An 15mm espesor 2mm autoadhesivo UE 1 para FAGOR panel control horno a vapor combinado L 540mm		
Para modelos:	AIC0037-F, AIC0038-F, AIC0039-F, AIC0040-F, AIC0041-F, AIC0042-F, AIC0043-F, AIC0044-F, AIC0045-F, AIC0046-F, AIC0071-F, AIC0072-F, AIC0073-F, AIC0074-F, AIC0075-F, AIC0076-F, AIC0077-F, AIC0078-F, AIC0079-F, AIC0080-F		

cordones de junta

cuadrado



código	694980	referencia	953.004.00
descripción	junta de estopa cuadrado tamaño 12x12mm trenzado L 1.05m para placa de cocina		
Para modelos:	V70120TPPCFG2, V70120TPPCG2T, V90120TPPCFG2, V90120TPPCG2T, VS70120TPFG, VS7080TPFG, VS7080TPGT, VS7080TPPCFG, VS7080TPPCGT, VS90120TPFG, VS9080TPFG, VS9080TPGT, VS9080TPPCFG, VS9080TPPCGT		

juntas de árbol

juntas de árbol



código	691049	referencia	12024510
descripción	junta radial int.ø 17mm ø ext. 28mm espesor 7mm		
Para modelos:	AIC0037-F, AIC0038-F, AIC0039-F, AIC0040-F, AIC0041-F, AIC0042-F, AIC0043-F, AIC0044-F, AIC0045-F, AIC0046-F, AIC0071-F, AIC0072-F, AIC0073-F, AIC0074-F, AIC0075-F, AIC0076-F, AIC0077-F, AIC0078-F, AIC0079-F, AIC0080-F		

juntas especiales

juntas de puerta para lavavajillas

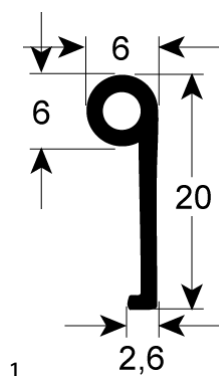

código	518123	referencia	41247
descripción	junta de puerta L 1050mm An 6mm H 20mm UE 1		
Para modelos:	GLB0041, GLB0042, GLB0043C, GLB0044C		

otros



código	551456	referencia	953.020.00
descripción	junta para interruptor ø ext. 14mm int.ø 2.5mm espesor 3.5mm blanco		
Para modelos:	V080FTREVCRT, V7040FTREVCRT, V9040FTREVCRT, V9080FTREVCRT, V9080FTRRECR, VS70120CFGE, VS7040BMET, VS7040BMFEP, VS7040CPES, VS7040FRE10, VS7040FRE17X, VS7040FRE88, VS7040FRG17VL, VS7040FTET, VS7040FTEVCRT, VS7040FTEVT, VS7040FTRET, VS7040FTREVT, VS7040GRACQE, VS7040PCEQT, VS7040PCET, VS7040SPET, VS7080BMET, VS7080BMFEP, VS7080BREI, VS7080BREIM, VS7080BRGI, VS7080BRGIM, VS7080CFE, VS7080CFEQ, VS7080CFGE, VS7080CFVE, VS7080CPES, VS7080FRE10, VS7080FRE17X, VS7080FRG17VL, VS7080FTET, VS7080FTEVCRT, VS7080FTEVT, VS7080FTRET, VS7080FTREVT, VS7080FTRRET, VS7080FTRREVC, VS7080FTRREVT, VS7080GRACQE, VS7080PCEQT, VS7080PCET, VS7080PEI50, VS7080PG50, VS7080PGI50...(Otros modelos se puede ver en la tienda web)		



código	511999	referencia	75168
descripción	junta por brida ø ext. 123mm int.ø 46mm goma espesor 3mm dist. del agujero 53mm		
Para modelos:	GLB0045, GLB0047, GLB0048, GLB0049, GLB0050, GLB0051		

juntas patra brazos de lavado



código	518402	referencia	437050
descripción	junta con 3 orificios roscados soporte brazo de lavado dist. del agujero 61mm D2 ø 34mm espesor 2.5mm agujero ø 34mm		
Para modelos:	GLB0045, GLB0047, GLB0048, GLB0049, GLB0050, GLB0051		



código	518339	referencia	437064
descripción	junta D2 ø 50mm espesor 2mm con 3 orificios roscados soporte brazo de lavado núm. Ref. 437064 para COLGED agujero ø 50mm dist. del agujero 67mm		
Para modelos:	GLB0040, GLB0041		

componentes para el circuito frigorífico

filtros deshidratadores antiácidos

otros



1

código	750047	referencia	A00DR100
descripción	deshidratador tamaño 30g ø 24mm L 143mm empalme 6,5/6,5mm tipo DP20-DP70,DP140		
Para modelos:	BMA0008-F, BMA0010-F, BMA0021-F, BMA0022-F, BMA0024-F, BMA0025-F, BMA0026-F, BMA0027-F, BMA0028-F, BMA0029-F, BMA0032-F, BMA0035-F, BMA0036-F, BMB0028-F, BMB0029-F, BMB0030-F, BMB0033-F, BMB0034-F, BMB0035-F, BMB0036-F, BMB0037-F, BMC0012-F, BMC0014-F, BMC0015-F, BMC0016-F, BNA0036-F, BNA0037-F, BNA0045-F, BNA0064-F, BNA0065-F, BNA0066-F, BNZ0007-F, CCZ0036-F, CCZ0037-F, PB9RI-F, VTGB4A-F		

evaporadores para frigoríficos

específico del fabricante



1

código	750402	referencia	01A01EV270
descripción	evaporador L 420mm H 455mm espesor 105mm FRENOX		
Para modelos:	BNA0052-F, BNA0053-F, BNA0064-F		

específico del fabricante



1

código	750405	referencia	01A01EV371
descripción	evaporador doble para congelación FRENOX		
Para modelos:	BNB0012-F, BNB0013-F, BNB0014-F, BNB0015-F, VTGB4A-F		



1

código	750655	referencia	A00EV701
descripción	evaporador L 389mm An 100mm H 200mm longitud total 505mm anchura total 105mm altura total 200mm		
Para modelos:	BMA0026-F, BMA0032-F, BMB0028-F, BMB0029-F, BMB0033-F, BMB0034-F, BMC0015-F, PB9RI-F		



1

código	750653	referencia	A00EV150
descripción	evaporador L 390mm An 100mm H 195mm longitud total 465mm anchura total 100mm altura total 200mm		
Para modelos:	BMB0035-F, BMB0036-F, BMB0037-F		



1

código	750546	referencia	A00SHP009
descripción	evaporador L 395mm An 105mm H 367mm apto para FRENOX completo con ventilador		
Para modelos:	BMA0021-F, BMA0022-F, BMB0030-F, BMC0012-F, BMC0014-F, BMC0016-F		



1

código	750654	referencia	A00EV700
descripción	evaporador L 400mm An 96mm H 200mm longitud total 480mm anchura total 103mm altura total 200mm		
Para modelos:	BMA0008-F, BMA0010-F, BMA0027-F		



1

código	750401	referencia	A00EV140
descripción	evaporador L 410mm An 100mm H 200mm longitud total 480mm distancia de sujeción 1 65mm apto para FRENOX		
Para modelos:	BMA0028-F		



1

código	750404	referencia	01A01EV271
descripción	evaporador L 410mm An 110mm H 445mm para congelación FRENOX		
Para modelos:	BNB0010-F, BNB0011-F, BNB0012-F, BNB0013-F, BNZ0007-F, CCZ0036-F, CCZ0037-F		



1

código	750406	referencia	01A01EV372
descripción	evaporador L 415mm An 105mm H 480mm doble para refrigeración FRENOX		
Para modelos:	BNA0036-F, BNA0037-F, BNA0045-F, BNA0054-F, BNA0055-F, BNA0057-F, BNA0065-F, BNA0066-F		

para mesas frías



1

código	750651	referencia	A00EV101
descripción	evaporador L 390mm An 90mm H 200mm longitud total 400mm anchura total 95mm altura total 430mm		
Para modelos:	BNA0044-F, BNA0056-F, BNB0010-F, BNB0011-F, BNB0012-F, BNB0013-F, BNB0014-F, BNB0015-F, BNZ0004-F, BNZ0006-F, BNZ0007-F, BNZ0008-F, CCZ0036-F, CCZ0037-F, VTGB2A-F, VTGB2-F, VTGB3A-F, VTGB3-F, VTGB4A-F, VTGB4-F		

para vitrinas frías



1

código	750650	referencia	A00EV100
descripción	evaporador L 390mm An 90mm H 150mm longitud total 400mm anchura total 95mm altura total 430mm		
Para modelos:	BNA0030-F, BNA0031-F, BNA0036-F, BNA0037-F, BNA0045-F, BNA0052-F, BNA0053-F, BNA0054-F, BNA0055-F, BNA0057-F, BNA0064-F, BNA0065-F, BNA0066-F, BNZ0002-F, CCZ0036-F, CCZ0037-F		

bandejas de agua condensada y cubetas de evaporación

bandejas de agua condensada

			
1			
código	750524	referencia	B01BH101
descripción	bandeja de agua condensada sin resistencia L 416mm An 103mm H 35mm		
Para modelos:	BNA0030-F, BNA0031-F, BNA0036-F, BNA0037-F, BNA0044-F, BNA0045-F, BNA0052-F, BNA0053-F, BNA0054-F, BNA0055-F, BNA0056-F, BNA0057-F, BNA0064-F, BNA0065-F, BNA0066-F, BNB0010-F, BNB0011-F, BNB0012-F, BNB0013-F, BNB0014-F, BNB0015-F, BNZ0002-F, BNZ0004-F, BNZ0007-F, BNZ0008-F, CCZ0036-F, CCZ0037-F, VTGB2A-F, VTGB2-F, VTGB3A-F, VTGB3-F, VTGB4A-F, VTGB4-F		

cubetas de evaporación sin resistencia

			
1			
código	750645	referencia	B00BH102 B01BH102
descripción	bandeja de agua condensada L 298mm An 88mm H 50mm plástico		
Para modelos:	BNA0030-F, BNA0031-F, BNA0036-F, BNA0037-F, BNA0044-F, BNA0045-F, BNA0056-F, BNA0064-F, BNA0065-F, BNA0066-F, BNZ0001-F, BNZ0002-F, BNZ0003-F, BNZ0004-F, BNZ0005-F, BNZ0006-F, BNZ0007-F, BNZ0008-F, CCZ0036-F, CCZ0037-F, VTGB2A-F, VTGB2-F, VTGB3A-F, VTGB3-F, VTGB4A-F, VTGB4-F		

			
1			
código	750067	referencia	12036623
descripción	cubeta de evaporación L 255mm An 127mm H 70mm		
Para modelos:	BKZ0022-F, BKZ0023-F		

técnica de accionamiento y rodamientos de bolas

cadena

medios eslabones

			
1			
código	697841	referencia	91410620
descripción	medio eslabón simple DIN/ISO 08 B-1 división 1/2"		
Para modelos:	CBC0001, CBC0002, CBC0003, CBC0004		

muelles

muelles de torsión

			
1			
código	514527	referencia	260.119.00
descripción	resorte de torsión ø 32mm espesor de hilo 5.6mm L1 195mm L2 20mm L3 30mm pos. de montaje tapa UE 1 pzs para marmita		
Para modelos:	VS7080PEI50, VS7080PG50, VS7080PGI50		

			
1			
código	514522	referencia	260.116.00
descripción	resorte de torsión ø 34mm espesor de hilo 6mm L1 370mm L2 22mm L3 22mm pos. de montaje izquierdo UE 1 pzs para marmita		
Para modelos:	VS9080PEI150, VS9080PGI150		

			
1			
código	692811	referencia	12093685
descripción	resorte de torsión ø 34mm L2 6mm espesor de hilo 2mm L1 10mm L3 6mm UE 1 pzs		
Para modelos:	AIC0043-F, AIC0044-F, AIC0045-F, AIC0046-F, AIC0074-F, AIC0075-F, AIC0079-F, AIC0080-F		

resortes de compresión

			
1			
código	696750	referencia	927244 CMT13
descripción	resorte de compresión ø 20mm L 89.5mm espesor de hilo 2mm espirales 14 acero zincado		
Para modelos:	GLB0045, GLB0047, GLB0048, GLB0049, GLB0050, GLB0051		

			
1			
código	691090	referencia	12023716
descripción	resorte de compresión ø 7.1mm L 25.5mm espesor de hilo 0.7mm		
Para modelos:	AIC0037-F, AIC0038-F, AIC0039-F, AIC0040-F, AIC0041-F, AIC0042-F, AIC0043-F, AIC0044-F, AIC0045-F, AIC0046-F, AIC0071-F, AIC0072-F, AIC0073-F, AIC0074-F, AIC0075-F, AIC0076-F, AIC0077-F, AIC0078-F, AIC0079-F, AIC0080-F		

			
1			
código	700765	referencia	12024164
descripción	resorte de compresión ø 8.1mm L 20.4mm espesor de hilo 1.2mm		
Para modelos:	AIC0043-F, AIC0044-F, AIC0045-F, AIC0046-F, AIC0074-F, AIC0075-F, AIC0079-F, AIC0080-F		

resortes de gas

resortes de gas

			
1			
código	701299	referencia	35070
descripción	resorte de gas 50N elevación 150mm D1 ø 15mm D2 ø 6mm dist. del agujero 365.5mm agujero ø 6.5mm L 380mm		
Para modelos:	GLB0040		

resortes enrollados

resortes enrollados

			
1			
código	517450	referencia	77560
descripción	resorte enrollado An 51mm int.ø 31mm longitud de lengüeta 90mm		
Para modelos:	GLB0047, GLB0048, GLB0050, GLB0051		

			
1			
código	517449	referencia	75271
descripción	resorte enrollado L 95mm An 66mm		
Para modelos:	GLB0045, GLB0047, GLB0048, GLB0049, GLB0050, GLB0051		

resortes de tracción

			
1			
código	517406	referencia	260.120.00
descripción	muelle de tracción ø 29mm longitud total 230mm espesor de hilo 4mm para sartén basculante		
Para modelos:	VS7080BREI, VS7080BREIM, VS7080BRGI, VS7080BRGIM, VS9080BREI, VS9080BREIM, VS9080BRGI, VS9080BRGIM		

			
1			
código	701625	referencia	260.123.00
descripción	muelle de tracción ø 44mm longitud total 350mm espesor de hilo 5.8mm para sartén basculante		
Para modelos:	VS7080BREI, VS7080BRGI		

			
1			
código	701617	referencia	260.121.00
descripción	muelle de tracción ø 65mm longitud total 420mm espesor de hilo 8.5mm para sartén basculante		
Para modelos:	VS9080BREI, VS9080BRGI		

			
1			
código	517451	referencia	35020
descripción	muelle de tracción ø 8mm longitud total 150mm espesor de hilo 1mm UE 1 pzs		
Para modelos:	GLB0040		

manómetros

			
1			
código	542405	referencia	678.083.00
descripción	manómetro ø 63mm margen de presión 0 a 1bar 0 a 14,5PSI llenado de glicerina rosca 1/4" para marmita empalme lado posterior		
Para modelos:	VS7080PEI50, VS7080PGI50, VS9080PEI150, VS9080PGI150		

enrolladores de tubo y duchas de mano para lavado

enrolladores de tubo

enrolladores de mangueras para aparatos



código	542093	referencia	12024800 12040977
descripción	enrollador de mangueras completo con ducha de mano longitud de tubo 1.8m		
Para modelos:	AIC0037-F, AIC0038-F, AIC0039-F, AIC0040-F, AIC0041-F, AIC0042-F, AIC0043-F, AIC0044-F, AIC0045-F, AIC0046-F		

SEKO

versión empotrada

con control de frecuencia



código	361767 ¹	referencia	209021	
descripción	dosificador SEKO 3l/h 230VAC detergente tubo ø 4x6mm tipo de tubo K tubo Santoprene altura de aspiración 1.5m tipo NBR 3 8W versión empotrada bomba peristáltica			
Para modelos:	GLB0041			
repuestos para	361767			
	código	361815	referencia	—
	tubo flexible para bomba detergente tubo ø 6x10mm tubo ø 4x6mm tipo de tubo K tubo Santoprene tipo SEKO			

¹con tubo transportador y de aspiración

dosificadores

bombas dosificadoras

GERMAC

versión empotrada

con control de frecuencia



código	361795 ¹	referencia	19022347	
descripción	dosificador GERMAC regulación de frecuencia 3l/h 230VAC detergente tubo ø 4x6mm tubo termoplástico tipo G300 3.5W 230V código 82334968 incl. kit de montaje			
Para modelos:	GLB0067-F, GLB0082			
repuestos para	361795			
	código	361142	referencia	—
	kit de montaje detergente tipo de tubo 4x6mm longitud de tubo 2m PVC 2x tubo flexible/filtro recipiente/caño de pared transparente			
	código	361268	referencia	—
	dosificador GERMAC regulación de frecuencia 3l/h 230VAC detergente tubo ø 4x6mm tubo termoplástico tipo G300 versión empotrada medidas 67x72x101mm			
	código	361467	referencia	—
	tubo flexible para bomba GERMAC detergente tipo de tubo termoplástico tubo ø 6x10mm para modelo G43/G45/G53/G54/G55/G300/G305			

¹con accesorios



código	361215	referencia	209016	
descripción	dosificador SEKO regulación de frecuencia 0,3-3,0l/h 230VAC detergente tubo ø 4x6mm tipo de tubo K tubo Santoprene altura de aspiración 1.5m tipo PBR protección IP55 medidas 100x67x68mm consumo 3.5W			
Para modelos:	GLB0040, GLB0041, GLB0042, GLB0043C			
repuestos para	361215			
	código	361136	referencia	—
	enrollador manguera para dosificadoras agujero ø 4,8x4mm			
	código	361226	referencia	—
	placa electrónica L 59mm An 26mm regulación electrónica			
	código	361815	referencia	—
	tubo flexible para bomba detergente tubo ø 6x10mm tubo ø 4x6mm tipo de tubo K tubo Santoprene tipo SEKO			
accesorios para	361215			
	código	361142	referencia	—
	kit de montaje detergente tipo de tubo 4x6mm longitud de tubo 2m PVC 2x tubo flexible/filtro recipiente/caño de pared transparente			
	código	520090	referencia	143194
	tubo flexible de PVC int.ø 4mm ø ext. 6mm L 2m grosor de la pared 1mm T máx 60°C transparente			
	código	520091	referencia	—
	tubo de nylon int.ø 4mm ø ext. 6mm L 2m grosor de la pared 1mm p de trabajo 10bar p de reventamiento 50bar T máx 100°C transparente			

sin regulación



1

código	361902	referencia	209039
descripción	dosificador SEKO 3l/h 230VAC detergente tubo ø 4x6mm tipo de tubo L tubo Santoprene altura de aspiración 1.5m tipo NPG 3		
Para modelos:	GLB0043C-60Hz		
repuestos para	361902		
	código	362004	referencia 143267
	tubo flexible de dosificación SEKO detergente tubo ø 6x9mm longitud de tubo 138mm tubo ø 4x6mm tipo de tubo L tubo Santoprene		



1

código	361929 ¹	referencia	209036
descripción	dosificador SEKO sin regulación 0.4l/h 230VAC abrillantador tubo ø 4x6mm tipo de tubo E tubo Sekobril altura de aspiración 1.5m tipo NPG 0.4 8W longitud del cable 45mm versión empotrada con válvula antirretorno		
Para modelos:	GLB0043C-60Hz		
repuestos para	361929		
	código	361925	referencia 143266
	tubo flexible para bomba SEKO abrillantador tubo ø 3x8mm con válvula antirretorno tubo ø 6mm tipo de tubo E tubo Sekobril		

¹con accesorios

piezas de repuesto



1

código	362004	referencia	143267
descripción	tubo flexible de dosificación SEKO detergente tubo ø 6x9mm longitud de tubo 138mm tubo ø 4x6mm tipo de tubo L tubo Santoprene		
Para modelos:	GLB0043C-60Hz		



1

código	361925 ¹	referencia	143266
descripción	tubo flexible para bomba SEKO abrillantador tubo ø 3x8mm con válvula antirretorno tubo ø 6mm tipo de tubo E tubo Sekobril		
Para modelos:	GLB0043C-60Hz		

¹con válvula antirretorno

bombas de membrana

autoaspirantes con presión secundaria

SEKO



1

código	362013	referencia	929198
descripción	dosificador tipo DIB P con empalme de presión secundaria para lavavajillas caudal 0-3cm ³ por carrera empalme presión ø 4x6mm conector para succión ø 4x6mm presión secundaria 10mm SEKO		
Para modelos:	GLB0040, GLB0041, GLB0042, GLB0043C		

accesorios

filtros de recipientes



1

código	361062	referencia	12011355
descripción	filtro de recipiente tubo ø 4mm		
Para modelos:	GLB0067-F, GLB0069-F, GLB0071-F, GLB0080, GLB0081, GLB0082		



1

código	361141	referencia	121075
descripción	filtro de recipiente con pesa cerámica tubo ø 4mm		
Para modelos:	GLB0041, GLB0042, GLB0043C, GLB0043C-60Hz, GLB0044C		

pesas para filtros



1

código	505409	referencia	12024353
descripción	pesa para filtros int.ø 7.6mm ø ext. 20 L 6mm 12g inox		
Para modelos:	GLB0067-F, GLB0069-F, GLB0071-F, GLB0080, GLB0081, GLB0082		

tubos flexibles

tubos flexibles de PVC



código	520090	referencia	143194
descripción	tubo flexible de PVC int.ø 4mm ø ext. 6mm L 2m grosor de la pared 1mm T máx 60°C transparente		
Para modelos:	GLB0043C-60Hz		
accesorios para	520090		
	código	361058	referencia —
	descripción	filtro de recipiente con válvula antirretorno inox tubo ø 4x6mm ø 20mm L 56mm	
	código	361066	referencia —
	descripción	filtro de recipiente recto inox tubo ø 4x6mm L 37mm válvula de retención válvula de bola	
	código	361106	referencia —
	descripción	filtro de recipiente con pesa y válvula de retención inox tubo ø 4x6mm ø 21mm L 51mm válvula de retención válvula labial	
	código	361141	referencia 121075
	descripción	filtro de recipiente con pesa cerámica tubo ø 4mm	
	código	361230	referencia —
	descripción	filtro de recipiente con pesa acero inoxidable tubo ø 4x6mm	
	código	361462	referencia —
	descripción	filtro de recipiente con pesa inox tubo ø 4x6mm	
	código	361728	referencia —
	descripción	filtro de recipiente con 4m 4x6 tubo flexible inox tubo ø 4x6mm longitud de tubo 4000mm	

caños de pared



código	508427	referencia	12024531
descripción	caño de pared acero inoxidable M10 tubo ø 4mm		
Para modelos:	GLB0067-F, GLB0071-F, GLB0080, GLB0081, GLB0082		



código	361270	referencia	468151
descripción	caño de pared inox M12 tubo ø 4mm		
Para modelos:	GLB0041, GLB0042, GLB0043C, GLB0043C-60Hz, GLB0044C		

diversos





código	505228	referencia	12024067
descripción	casquillo distanciador int.ø 4.5mm ø ext. 10mm L 16mm para dosificadoras		
Para modelos:	AIC0043-F, AIC0044-F, AIC0045-F, AIC0046-F, AIC0074-F, AIC0075-F, AIC0079-F, AIC0080-F		
repuestos para	505228		
	código	361221	referencia —
	descripción	dosificador tipo N6 abrillantador empalme presión ø 4x6mm conector para succión ø 6x8mm LANG	

tubos flexibles

tubos flexibles de entrada

tubos flexibles de entrada de PVC



código	520010	referencia	12024115
descripción	tubo flexible de entrada PVC recto-curvado DN13 empalmes 3/4" L 1500mm p de trabajo 10bar p de reventamiento 32bar T máx 90°C azul homologación VDE cierre plana		
Para modelos:	GLB0067-F, GLB0069-F, GLB0071-F, GLB0080, GLB0081, GLB0082		
accesorios para	520010		
	código	520053	referencia —
	descripción	filtro empalme 3/4" D1 ø 26mm D2 ø 15mm UE 10 pzs goma espesor 8mm	
	código	520054	referencia —
	descripción	junta plana goma ø ext. 23.5mm int.ø 14mm espesor 2.3mm UE 10 pzs	

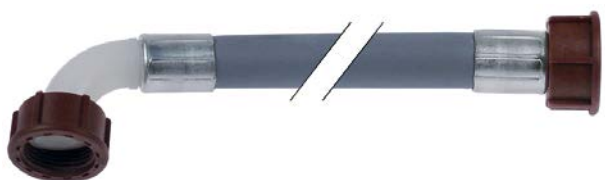

código	520011	referencia	929169
descripción	tubo flexible de entrada PVC recto-curvado DN13 empalmes 3/4" L 2000mm p de trabajo 10bar p de reventamiento 32bar T máx 90°C homologación VDE cierre plana		
Para modelos:	GLB0041, GLB0042, GLB0043C, GLB0043C-60Hz, GLB0044C		

1

código	520012	referencia	12025198
descripción	tubo flexible de entrada PVC recto-curvado DN13 empalmes 3/4" L 2500mm p de trabajo 10bar p de reventamiento 32bar T máx 90°C homologación VDE cierre plana		
Para modelos:	AIC0037-F, AIC0038-F, AIC0039-F, AIC0040-F, AIC0041-F, AIC0042-F, AIC0043-F, AIC0044-F, AIC0045-F, AIC0046-F, AIC0071-F, AIC0072-F, AIC0073-F, AIC0074-F, AIC0075-F, AIC0076-F, AIC0077-F, AIC0078-F, AIC0079-F, AIC0080-F		



1

código	505084	referencia	12023666
descripción	manguera de desagüe DN19 L 2000mm ø int. recta 21mm ø ext. recto 26mm dim.ext. codo 21mm ø ext. codo 27mm tubo ø ext. 27mm		
Para modelos:	GLB0069-F		

tubos de salida



1

código	505082	referencia	12024473
descripción	manguera de desagüe DN25 L 1500mm dim.ext. codo 48mm ø ext. codo 58mm tubo ø ext. 31mm		
Para modelos:	AIC0037-F, AIC0038-F, AIC0039-F, AIC0040-F, AIC0041-F, AIC0042-F, AIC0043-F, AIC0044-F, AIC0045-F, AIC0046-F, GLB0082		

tubos flexibles industriales

tubos Niplaflex



1

código	530561	referencia	11000083
descripción	tubo de presión int.ø 10mm ø ext. 17mm L 5m grosor de la pared 3.5mm p de trabajo 10bar p de reventamiento 30bar T máx 110°C		
Para modelos:	AIC0037-F, AIC0038-F, AIC0039-F, AIC0040-F, AIC0041-F, AIC0042-F, AIC0043-F, AIC0044-F, AIC0045-F, AIC0046-F, GLB0067-F, GLB0069-F, GLB0071-F, GLB0080, GLB0081, GLB0082		

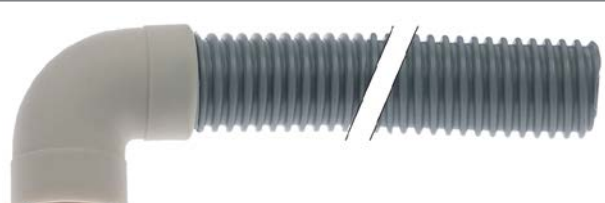

1

código	505402	referencia	12115471
descripción	manguera de desagüe DN25 L 2000mm dim.ext. codo 27mm ø ext. codo 35mm tubo ø int. 25mm tubo ø ext. 30mm plástico		
Para modelos:	GLB0067-F		



1

código	530562	referencia	143010
descripción	tubo de presión int.ø 13mm ø ext. 21mm L 5m p de trabajo 10bar p de reventamiento 30bar T máx 110°C		
Para modelos:	GLB0040, GLB0041, GLB0042, GLB0043C, GLB0043C-60Hz, GLB0044C, GLB0045, GLB0047, GLB0048, GLB0049, GLB0050, GLB0051		



1

código	518068	referencia	143136
descripción	manguera de desagüe DN34 L 2000mm dim.ext. codo 50mm ø ext. codo 59mm tubo ø int. 35mm tubo ø ext. 42mm PVC		
Para modelos:	GLB0040, GLB0041, GLB0042		

tubos de presostato



1

código	530560	referencia	11000066 143005 143131
descripción	tubo de presostato int.ø 5mm ø ext. 9mm L 5m p de trabajo 30bar p de reventamiento 90bar resis.a la temp. 60°C		
Para modelos:	GLB0040, GLB0041, GLB0042, GLB0043C, GLB0043C-60Hz, GLB0044C, GLB0045, GLB0047, GLB0048, GLB0049, GLB0050, GLB0051, GLB0067-F, GLB0069-F, GLB0071-F, GLB0080, GLB0081, GLB0082		

tubos flexibles de PVC

tubos de PVC sin tejido



código	520383	referencia	H.775601
descripción	tubo flexible de PVC int.ø 4mm ø ext. 6mm L 2m grosor de la pared 1mm T máx 60°C azul		
Para modelos:	GLB0043C-60Hz		
accesorios para	520383		
	código	361058	referencia —
	filtro de recipiente con válvula antirretorno inox tubo ø 4x6mm ø 20mm L 56mm		
	código	361066	referencia —
	filtro de recipiente recto inox tubo ø 4x6mm L 37mm válvula de retención válvula de bola		
	código	361106	referencia —
	filtro de recipiente con pesa y válvula de retención inox tubo ø 4x6mm ø 21mm L 51mm válvula de retención válvula labial		
	código	361141	referencia 121075
	filtro de recipiente con pesa cerámica tubo ø 4mm		
	código	361230	referencia —
	filtro de recipiente con pesa acero inoxidable tubo ø 4x6mm		
	código	361462	referencia —
	filtro de recipiente con pesa inox tubo ø 4x6mm		
	código	361728	referencia —
	filtro de recipiente con 4m 4x6 tubo flexible inox tubo ø 4x6mm longitud de tubo 4000mm		



código	520090	referencia	143194
descripción	tubo flexible de PVC int.ø 4mm ø ext. 6mm L 2m grosor de la pared 1mm T máx 60°C transparente		
Para modelos:	GLB0043C-60Hz		
accesorios para	520090		
	código	361058	referencia —
	filtro de recipiente con válvula antirretorno inox tubo ø 4x6mm ø 20mm L 56mm		
	código	361066	referencia —
	filtro de recipiente recto inox tubo ø 4x6mm L 37mm válvula de retención válvula de bola		
	código	361106	referencia —
	filtro de recipiente con pesa y válvula de retención inox tubo ø 4x6mm ø 21mm L 51mm válvula de retención válvula labial		
	código	361141	referencia 121075
	filtro de recipiente con pesa cerámica tubo ø 4mm		
	código	361230	referencia —
	filtro de recipiente con pesa acero inoxidable tubo ø 4x6mm		
	código	361462	referencia —
	filtro de recipiente con pesa inox tubo ø 4x6mm		

accesorios para	520090		
	código	361728	referencia —
	filtro de recipiente con 4m 4x6 tubo flexible inox tubo ø 4x6mm longitud de tubo 4000mm		

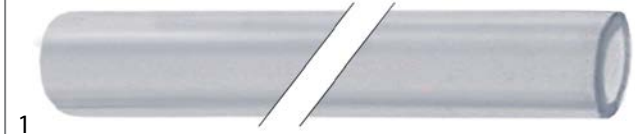

código	520935	referencia	H.165168
descripción	tubo flexible de PVC int.ø 6mm ø ext. 9mm L 1m transparente sistemas de lavado		
Para modelos:	GLB0043C-60Hz		

tubos de silicona

sin tejido



código	520399 ¹	referencia	11000157
descripción	tubo de silicona int.ø 18mm ø ext. 26mm Lm grosor de la pared 4mm T máx 200°C rojo		
Para modelos:	AIC0037-F, AIC0038-F, AIC0039-F, AIC0040-F, AIC0041-F, AIC0042-F, AIC0043-F, AIC0044-F, AIC0045-F, AIC0046-F		

¹al metro



código	520842	referencia	143253
descripción	tubo de silicona int.ø 3mm ø ext. 6mm L 1m grosor de la pared 1.5mm T máx 200°C marrón		
Para modelos:	GLB0043C-60Hz		

tubos formados

recto



código	694706	referencia	12024122
descripción	tubo flexible int.ø 52mm ø ext. 57 L 363mm silicona salida de aire generador de vapor rojo UE 1		
Para modelos:	AIC0037-F, AIC0038-F, AIC0039-F, AIC0040-F, AIC0041-F, AIC0042-F, AIC0043-F, AIC0044-F, AIC0045-F, AIC0046-F, AIC0071-F, AIC0072-F, AIC0073-F, AIC0074-F, AIC0075-F, AIC0076-F, AIC0077-F, AIC0078-F, AIC0079-F, AIC0080-F		



			
código	513294	referencia	41525 43149
descripción	tubo formado ø tubo 20mm int.ø 13mm int. ø tubo 25mm L 1350mm		
Para modelos:	GLB0040, GLB0041, GLB0042, GLB0043C-60Hz, GLB0044C, GLB0049, GLB0050, GLB0051		

forma L

			
código	530918	referencia	12039649
descripción	tubo flexible int.ø 30mm ø ext. 40mm L 110mm para generador de vapor		
Para modelos:	AIC0038-F, AIC0040-F, AIC0041-F, AIC0042-F, AIC0043-F, AIC0044-F, AIC0045-F, AIC0046-F		

			
código	530919	referencia	12044832
descripción	tubo flexible int.ø 73mm ø ext. 85mm L 150mm para generador de vapor		
Para modelos:	AIC0046-F		

			
código	513250	referencia	80188
descripción	tubo formado int.ø 48mm ø ext. 60mm grosor de la pared 6mm L1 235mm L2 140mm L-Form		
Para modelos:	GLB0040, GLB0049, GLB0050, GLB0051		

			
código	513254	referencia	80186
descripción	tubo formado L 340mm sistemas de lavado L-Form núm. Ref. 80186 int.ø 60mm		
Para modelos:	GLB0040, GLB0047, GLB0048, GLB0050, GLB0051		

			
código	503176	referencia	127098
descripción	tubo formado sistemas de lavado		
Para modelos:	GLB0043C-60Hz		

			
código	513135	referencia	926056
descripción	tubo formado sistemas de lavado L-Form núm. Ref. 926056, DZG461		
Para modelos:	GLB0041, GLB0042, GLB0043C, GLB0043C-60Hz, GLB0044C, GLB0045, GLB0047, GLB0048, GLB0049, GLB0050, GLB0051		

			
código	513075	referencia	929164
descripción	tubo formado sistemas de lavado L-Form núm. Ref. DZG60, 929164		
Para modelos:	GLB0041, GLB0042, GLB0043C, GLB0043C-60Hz, GLB0044C, GLB0045, GLB0047, GLB0048, GLB0049, GLB0050, GLB0051		



1

código	513305	referencia	35603
descripción	tubo formado terminal ø ext. 51mm altura interior 44mm ø DE2 42mm medida interior 33mm L 300mm		
Para modelos:	GLB0040		



1

código	513251	referencia	80187
descripción	tubo formado terminal ø ext. 59mm altura interior 47mm ø DE2 58mm medida interior 46mm sistemas de lavado L-Form núm. Ref. 80187 pos. de montaje arriba		
Para modelos:	GLB0045, GLB0047, GLB0048		

forma U



1

código	513315	referencia	43555
descripción	tubo formado ø ext. 52 D1 ø 44mm L 1200mm		
Para modelos:	GLB0043C-60Hz		



1

código	513199	referencia	69068
descripción	tubo formado para bomba de salida sistemas de lavado		
Para modelos:	GLB0043C-60Hz		

para lavavajillas

otros



1

código	530770	referencia	929171
descripción	tubo flexible ø ext. 30mm int.ø 20mm L 1050mm goma negro UE 1		
Para modelos:	GLB0040, GLB0041, GLB0042, GLB0043C, GLB0043C-60Hz, GLB0044C		



1

código	698706	referencia	127095
descripción	tubo flexible ø ext. 31mm int.ø 25mm L 34mm plástico para aclarado		
Para modelos:	GLB0043C-60Hz		

guarniciones, empalmes para mangueras y tubos

empalmes de tubos

sin racor



1

código	505088	referencia	12023511
descripción	pieza Y plástico tubo ø 12-12-12mm L 75mm		
Para modelos:	GLB0071-F, GLB0080, GLB0082		



1

código	541109	referencia	12023510
descripción	pieza Y plástico tubo ø 8-6-8mm para presóstato		
Para modelos:	GLB0067-F, GLB0069-F		

empalmes de tubo

latón



1

código	513253	referencia	108006
descripción	empalme de tubo latón acodado rosca 1/4" tubo ø 12mm UE 1 pzs		
Para modelos:	GLB0048		



latón niquelado



1

código	520202	referencia	927015
descripción	empalme de tubo latón niquelado recto rosca 3/8" tubo ø 12mm UE 1 pzs		
Para modelos:	GLB0043C, GLB0044C, GLB0045, GLB0047, GLB0048, GLB0049, GLB0050, GLB0051		

válvulas y caños de pared

válvulas de bola

universal

válvulas de bola con maneta de mariposa



1

código	540775	referencia	678.014.00	
descripción	válvula de bola empalme 1" H - 1" H DN25 longitud 68mm			
Para modelos:	VS7040CPES, VS7040CPGS, VS7080CPES, VS7080CPGS, VS9040CPES, VS9040CPGS, VS9080CPES, VS9080CPGS			
accesorios para	540775			
	código	514529	referencia	—
	manilla plástico/metal L 150mm para válvula An 120mm H 25mm asidero ø 28mm			

válvulas de cierre

universal



1

código	520548	referencia	678.065.25
descripción	válvula de bola completo con manilla en forma de estrella H 84mm L 101mm An 26mm eje ø 7.5mm grifo de entrada M 3/8"		
Para modelos:	VS7040CPES, VS7040CPGS, VS7080CPES, VS7080CPGS, VS9040CPES, VS9040CPGS, VS9080CPES, VS9080CPGS		

válvulas de entrada



1

código	542394	referencia	256.466.00
descripción	tubo de entrada empalme 1/2" tubo ø 25mm altura total 150mm ángulo de rotación°		
Para modelos:	VS7080BREI, VS7080BREIM, VS7080BRGI, VS7080BRGIM, VS9080BREI, VS9080BREIM, VS9080BRGI, VS9080BRGIM		



1

código	542393	referencia	256.313.00
descripción	tubo de entrada empalme 3/8" tubo ø 12mm altura total 67mm ángulo de rotación°		
Para modelos:	VS7040CPES, VS7040CPGS, VS7080CPES, VS7080CPGS, VS9040CPES, VS9040CPGS, VS9080CPES, VS9080CPGS		

componentes para el circuito agua

reductores de presión

reductores de presión

universal



1

código	520868	referencia	927150
descripción	reductor de presión OR serie PN40 empalme 1/2" margen de ajuste 1-7bar p máx. 40bar T máx 80°C latón		
Para modelos:	GLB0045, GLB0047, GLB0048, GLB0049, GLB0050, GLB0051		

material auxiliar

abrazaderas

abrazaderas de tubo

DIN 3017 - W2



1

código	520117	referencia	12009962
descripción	abrazadera de tubo acero inoxidable ø 40-60mm ancho 9mm UE 5 pzs DIN 3017		
Para modelos:	AIC0037-F, AIC0038-F, AIC0039-F, AIC0040-F, AIC0041-F, AIC0042-F, AIC0043-F, AIC0044-F, AIC0045-F, AIC0046-F, AIC0071-F, AIC0072-F, AIC0073-F, AIC0074-F, AIC0075-F, AIC0076-F, AIC0077-F, AIC0078-F, AIC0079-F, AIC0080-F, GLB0067-F, GLB0069-F, GLB0071-F, GLB0080, GLB0081, GLB0082		



1

código	520114	referencia	12010023
descripción	abrazadera de tubo ø 20-32mm ancho 9mm UE 10 pzs DIN 3017		
Para modelos:	AIC0037-F, AIC0038-F, AIC0039-F, AIC0040-F, AIC0041-F, AIC0042-F, AIC0043-F, AIC0044-F, AIC0045-F, AIC0046-F, GLB0069-F, GLB0071-F, GLB0080, GLB0081, GLB0082		



1

código	520115	referencia	12009997
descripción	abrazadera de tubo ø 25-40mm ancho 9mm UE 10 pzs DIN 3017		
Para modelos:	AIC0037-F, AIC0038-F, AIC0039-F, AIC0040-F, AIC0041-F, AIC0042-F, AIC0043-F, AIC0044-F, AIC0045-F, AIC0046-F, GLB0067-F, GLB0069-F, GLB0081		



1

código	520118	referencia	12009933
descripción	abrazadera de tubo ø 50-70mm ancho 9mm UE 5 pzs DIN 3017		
Para modelos:	GLB0067-F, GLB0069-F, GLB0081		



1

código	520454	referencia	12009914
descripción	abrazadera de tubo ø 70-90mm ancho 9mm UE 5 pzs DIN 3017		
Para modelos:	AIC0045-F, AIC0046-F, AIC0075-F, AIC0080-F		

DIN 3017 - W4



1

código	520120	referencia	12010036 927322
descripción	abrazadera de tubo inox W4 ø 12-20mm ancho 9mm UE 1 pzs DIN 3017		
Para modelos:	AIC0037-F, AIC0038-F, AIC0039-F, AIC0040-F, AIC0041-F, AIC0042-F, AIC0043-F, AIC0044-F, AIC0045-F, AIC0046-F, GLB0043C-60Hz, GLB0067-F, GLB0069-F, GLB0071-F, GLB0080, GLB0081, GLB0082		

abrazaderas de alambre doble



1

código	560503	referencia	CFF10073
descripción	abrazadera de tubo ø 8-10mm espesor de hilo 1mm UE 1 pzs		
Para modelos:	GLB0043C-60Hz		

herramientas

herramientas de limpieza

rasquetas



1

código	705023	referencia	610.272.00
descripción	rasqueta An 100mm L 420mm		
Para modelos:	VS7040GRACQE, VS7040GRACQG, VS7080GRACQE, VS7080GRACQG, VS9040GRACQE, VS9040GRACQG, VS9080GRACQE, VS9080GRACQG		



material de sujeción

remaches/tuercas de remache

remaches ciegos DIN 7337 - acero inoxidable

			
1			
código	560157	referencia	12010065
descripción	remache ciego inox ø 3.2mm L 6mm UE 50 pzs DIN 1700		
Para modelos:	AIC0043-F, AIC0044-F, AIC0045-F, AIC0046-F, AIC0074-F, AIC0075-F, AIC0079-F, AIC0080-F		

			
1			
código	560049	referencia	12010090
descripción	remache ciego inox ø 4mm L 7.5mm UE 50 pzs		
Para modelos:	AIC0037-F, AIC0038-F, AIC0039-F, AIC0040-F, AIC0041-F, AIC0042-F, AIC0043-F, AIC0044-F, AIC0045-F, AIC0046-F, AIC0073-F, AIC0074-F, AIC0075-F, AIC0078-F, AIC0079-F, AIC0080-F		

tuercas de remaches ciegos hexagonales

			
1			
código	696427	referencia	12009970
descripción	tuerca de remache rosca M5 DN 4mm L 12mm inox UE 1 pzs ø 7mm EC 6		
Para modelos:	AIC0037-F, AIC0038-F, AIC0039-F, AIC0040-F, AIC0041-F, AIC0042-F, AIC0043-F, AIC0044-F, AIC0045-F, AIC0046-F, AIC0071-F, AIC0072-F, AIC0073-F, AIC0074-F, AIC0075-F, AIC0076-F, AIC0077-F, AIC0078-F, AIC0079-F, AIC0080-F		

			
1			
código	551034	referencia	12010163
descripción	tuerca de remache rosca M5 DN 7mm L 12mm UE 10 pzs		
Para modelos:	AIC0037-F, AIC0038-F, AIC0039-F, AIC0040-F, AIC0041-F, AIC0042-F, AIC0043-F, AIC0044-F, AIC0045-F, AIC0046-F, AIC0071-F, AIC0072-F, AIC0073-F, AIC0074-F, AIC0075-F, AIC0076-F, AIC0077-F, AIC0078-F, AIC0079-F, AIC0080-F		

			
1			
código	550776	referencia	12010126
descripción	tuerca de remache rosca M6 DN 10mm L 15mm inox UE 1 pzs		
Para modelos:	AIC0037-F, AIC0038-F, AIC0039-F, AIC0040-F, AIC0041-F, AIC0042-F, AIC0043-F, AIC0044-F, AIC0045-F, AIC0046-F, AIC0071-F, AIC0072-F, AIC0073-F, AIC0074-F, AIC0075-F, AIC0076-F, AIC0077-F, AIC0078-F, AIC0079-F, AIC0080-F		

tornillos

tornillos de cabeza avellanada

			
1			
código	560041	referencia	12010199
descripción	tornillo de cabeza avellanada rosca M5 L 16mm EC 3 inox DIN 7991/ISO 10642 UE 20 pzs soporte Allen		
Para modelos:	AIC0037-F, AIC0038-F, AIC0039-F, AIC0040-F, AIC0041-F, AIC0042-F, AIC0071-F, AIC0072-F, AIC0073-F, AIC0076-F, AIC0077-F, AIC0078-F		

			
1			
código	560211	referencia	12010262
descripción	tornillo de cabeza avellanada rosca M4 L 14mm inox DIN 963/ISO 2009 UE 20 pzs soporte ranura ø cabezal 7.5mm		
Para modelos:	AIC0037-F, AIC0038-F, AIC0039-F, AIC0040-F, AIC0041-F, AIC0042-F, AIC0043-F, AIC0044-F, AIC0045-F, AIC0046-F, AIC0071-F, AIC0072-F, AIC0073-F, AIC0074-F, AIC0075-F, AIC0076-F, AIC0077-F, AIC0078-F, AIC0079-F, AIC0080-F		

tornillos de cabeza plana

			
1			
código	560062	referencia	12010278
descripción	tornillo de cabeza plana rosca M4 rosca L 10mm inox DIN 7985/ISO 7045 UE 20 pzs soporte Phillips ø cabezal 8mm espesor cabezal 2mm		
Para modelos:	AIC0037-F, AIC0038-F, AIC0039-F, AIC0040-F, AIC0041-F, AIC0042-F, AIC0043-F, AIC0044-F, AIC0045-F, AIC0046-F, AIC0071-F, AIC0072-F, AIC0073-F, AIC0074-F, AIC0075-F, AIC0076-F, AIC0077-F, AIC0078-F, AIC0079-F, AIC0080-F		

			
código	560061	referencia	12009876
descripción	tornillo de cabeza plana rosca M4 rosca L 6mm inox DIN 7985/ISO 7045 UE 20 pzs soporte Phillips ø cabezal 8mm espesor cabezal 2mm		
Para modelos:	AIC0037-F, AIC0038-F, AIC0039-F, AIC0040-F, AIC0041-F, AIC0042-F, AIC0043-F, AIC0044-F, AIC0045-F, AIC0046-F, AIC0071-F, AIC0072-F, AIC0073-F, AIC0074-F, AIC0075-F, AIC0076-F, AIC0077-F, AIC0078-F, AIC0079-F, AIC0080-F		

			
código	560083	referencia	12010238
descripción	tornillo de cabeza hexagonal rosca M5 rosca L 10mm inox EC 8 UE 20 pzs DIN 933 / ISO 4017		
Para modelos:	AIC0037-F, AIC0038-F, AIC0039-F, AIC0040-F, AIC0041-F, AIC0042-F, AIC0043-F, AIC0044-F, AIC0045-F, AIC0046-F, AIC0071-F, AIC0072-F, AIC0073-F, AIC0074-F, AIC0075-F, AIC0076-F, AIC0077-F, AIC0078-F, AIC0079-F, AIC0080-F		

			
código	560068	referencia	12010213
descripción	tornillo de cabeza plana rosca M5 rosca L 16mm inox DIN 7985/ISO 7045 UE 20 pzs soporte Phillips ø cabezal 10mm espesor cabezal 2mm		
Para modelos:	AIC0043-F, AIC0044-F, AIC0045-F, AIC0046-F, AIC0074-F, AIC0075-F, AIC0079-F, AIC0080-F		

			
código	524118	referencia	12010186
descripción	tornillo de cabeza hexagonal rosca M6 rosca L 16mm inox EC 10 UE 1 pzs DIN 933 / ISO 4017		
Para modelos:	AIC0037-F, AIC0038-F, AIC0039-F, AIC0040-F, AIC0041-F, AIC0042-F, AIC0043-F, AIC0044-F, AIC0045-F, AIC0046-F, AIC0071-F, AIC0072-F, AIC0073-F, AIC0074-F, AIC0075-F, AIC0076-F, AIC0077-F, AIC0078-F, AIC0079-F, AIC0080-F		

tornillos de cabeza de gota de sebo			
			
código	560057	referencia	12010242
descripción	tornillo de cabeza de gota de sebo rosca M5 L 13mm acero inoxidable soporte Phillips UE 10 pzs		
Para modelos:	AIC0037-F, AIC0038-F, AIC0039-F, AIC0040-F, AIC0041-F, AIC0042-F, AIC0043-F, AIC0044-F, AIC0045-F, AIC0046-F, AIC0071-F, AIC0072-F, AIC0073-F, AIC0074-F, AIC0075-F, AIC0076-F, AIC0077-F, AIC0078-F, AIC0079-F, AIC0080-F, GLB0071-F, GLB0080, GLB0082		

			
código	560088	referencia	12010180
descripción	tornillo de cabeza hexagonal rosca M6 rosca L 20mm inox EC 10 UE 20 pzs DIN 933 / ISO 4017		
Para modelos:	AIC0037-F, AIC0038-F, AIC0039-F, AIC0040-F, AIC0041-F, AIC0042-F, AIC0071-F, AIC0072-F, AIC0073-F, AIC0074-F, AIC0075-F, AIC0076-F, AIC0077-F, AIC0078-F		

tuercas hexagonales			
			
código	560311	referencia	12010030
descripción	tornillo de cabeza hexagonal rosca M10 rosca L 20mm inox EC 17 UE 1 pzs DIN 933 / ISO 4017		
Para modelos:	AIC0037-F, AIC0038-F, AIC0039-F, AIC0040-F, AIC0041-F, AIC0042-F, AIC0043-F, AIC0044-F, AIC0045-F, AIC0046-F, AIC0071-F, AIC0072-F, AIC0073-F, AIC0074-F, AIC0075-F, AIC0076-F, AIC0077-F, AIC0078-F, AIC0079-F, AIC0080-F		

			
código	506446	referencia	12010056
descripción	tornillo de cabeza hexagonal rosca M8 rosca L 40mm inox EC 13 UE 1 pzs DIN 933 / ISO 4017		
Para modelos:	AIC0037-F, AIC0038-F, AIC0039-F, AIC0040-F, AIC0041-F, AIC0042-F, AIC0043-F, AIC0044-F, AIC0045-F, AIC0046-F, AIC0071-F, AIC0072-F, AIC0073-F, AIC0074-F, AIC0075-F, AIC0076-F, AIC0077-F, AIC0078-F, AIC0079-F, AIC0080-F		

			
código	560081	referencia	12010249
descripción	tornillo de cabeza hexagonal rosca M4 rosca L 10mm inox EC 7 UE 20 pzs DIN 933 / ISO 4017		
Para modelos:	AIC0037-F, AIC0038-F, AIC0039-F, AIC0040-F, AIC0041-F, AIC0042-F, AIC0043-F, AIC0044-F, AIC0045-F, AIC0046-F, AIC0071-F, AIC0072-F, AIC0073-F, AIC0074-F, AIC0075-F, AIC0076-F, AIC0077-F, AIC0078-F, AIC0079-F, AIC0080-F		

tornillos de cabeza cilíndrica			
DIN 912/ISO 4762			
			
código	560380	referencia	12010084
descripción	tornillo de cabeza cilíndrica rosca M6 L 40mm rosca L 25mm EC 5 inox UE 1 pzs DIN 912/ISO 4762		
Para modelos:	AIC0038-F, AIC0040-F, AIC0042-F, AIC0044-F, AIC0046-F, AIC0076-F, AIC0077-F, AIC0078-F, AIC0079-F, AIC0080-F		



tornillos prisioneros			
DIN 916/ISO 4029			
			
1			
código	560549	referencia	12010236
descripción	tornillo prisionero rosca M6 L 15mm inox DIN 916/ISO 4029 soporte Allen hexagonal EC 3 UE 1 pzs		
Para modelos:	AIC0043-F, AIC0044-F, AIC0045-F, AIC0046-F, AIC0074-F, AIC0075-F, AIC0079-F, AIC0080-F		

barras roscadas			
otros			
			
1			
código	530900	referencia	941.162.00
descripción	barra roscada rosca M12x1,5 acero zincado rosca L 80mm		
Para modelos:	VS7080BREIM, VS7080BRGIM, VS9080BREIM, VS9080BRGIM		

tuercas			
tuercas hexagonales			
DIN 934 / ISO 4032/8673			
			
1			
código	560131	referencia	12009839
descripción	tuerca hexagonal rosca M4 H 3.2mm EC 7 inox DIN/ISO DIN 934 / ISO 4032/8673 UE 20 pzs		
Para modelos:	AIC0037-F, AIC0038-F, AIC0039-F, AIC0040-F, AIC0041-F, AIC0042-F, AIC0043-F, AIC0044-F, AIC0045-F, AIC0046-F, AIC0074-F, AIC0075-F		

			
1			
código	560132	referencia	12010284
descripción	tuerca hexagonal rosca M5 H 4mm EC 8 inox DIN/ISO DIN 934 / ISO 4032/8673 UE 20 pzs		
Para modelos:	AIC0037-F, AIC0038-F, AIC0039-F, AIC0040-F, AIC0041-F, AIC0042-F, AIC0043-F, AIC0044-F, AIC0045-F, AIC0046-F, AIC0071-F, AIC0072-F, AIC0073-F, AIC0074-F, AIC0075-F, AIC0076-F, AIC0077-F, AIC0078-F, AIC0079-F, AIC0080-F		

			
1			
código	511212	referencia	12010255
descripción	tuerca hexagonal rosca M6 H 5mm EC 10 inox DIN/ISO DIN 934 / ISO 4032/8673 UE 1 pzs		
Para modelos:	AIC0037-F, AIC0038-F, AIC0039-F, AIC0040-F, AIC0041-F, AIC0042-F, AIC0043-F, AIC0044-F, AIC0045-F, AIC0046-F, AIC0071-F, AIC0072-F, AIC0073-F, AIC0074-F, AIC0075-F, AIC0076-F, AIC0077-F, AIC0078-F, AIC0079-F, AIC0080-F		

			
1			
código	560134	referencia	12010210
descripción	tuerca hexagonal rosca M8 H 6.5mm EC 13 inox DIN/ISO DIN 934 / ISO 4032/8673 UE 20 pzs		
Para modelos:	AIC0037-F, AIC0038-F, AIC0039-F, AIC0040-F, AIC0041-F, AIC0042-F, AIC0043-F, AIC0044-F, AIC0045-F, AIC0046-F, AIC0071-F, AIC0072-F, AIC0073-F, AIC0074-F, AIC0075-F, AIC0076-F, AIC0077-F, AIC0078-F, AIC0079-F, AIC0080-F		

tuercas hexagonales métricas (sin norma)			
			
1			
código	102382	referencia	673.024.00
descripción	tuerca rosca M14x1 H 3.5mm EC 18 latón UE 1 pzs		
Para modelos:	VS7080BRGI, VS7080BRGIM, VS9080BRGI, VS9080BRGIM		

arandelas			
arandelas elásticas			
			
1			
código	560123	referencia	12009872
descripción	arandela grower int.ø 6.3mm ø ext. 11mm inox DIN127 UE 20 pzs para rosca M6		
Para modelos:	AIC0037-F, AIC0039-F, AIC0041-F, AIC0043-F, AIC0045-F, AIC0071-F, AIC0072-F, AIC0073-F, AIC0074-F, AIC0075-F		

arandelas

DIN 125A



código	560111	referencia	12009987
descripción	arandela int.ø 4.3mm ø ext. 9mm espesor 0.8mm inox UE 20 pzs DIN 125A para rosca M4		
Para modelos:	AIC0037-F, AIC0038-F, AIC0039-F, AIC0040-F, AIC0041-F, AIC0042-F, AIC0043-F, AIC0044-F, AIC0045-F, AIC0046-F, AIC0071-F, AIC0072-F, AIC0073-F, AIC0074-F, AIC0075-F, AIC0076-F, AIC0077-F, AIC0078-F, AIC0079-F, AIC0080-F		



código	560112	referencia	12009944
descripción	arandela int.ø 5.3mm ø ext. 10mm espesor 1mm inox UE 20 pzs DIN 125A para rosca M5		
Para modelos:	AIC0037-F, AIC0038-F, AIC0039-F, AIC0040-F, AIC0041-F, AIC0042-F, AIC0043-F, AIC0044-F, AIC0045-F, AIC0046-F, AIC0071-F, AIC0072-F, AIC0073-F, AIC0074-F, AIC0075-F, AIC0076-F, AIC0077-F, AIC0078-F, AIC0079-F, AIC0080-F		



código	560113	referencia	12009868
descripción	arandela int.ø 6.4mm ø ext. 12mm espesor 1.6mm inox UE 20 pzs DIN 125A para rosca M6		
Para modelos:	AIC0037-F, AIC0038-F, AIC0039-F, AIC0040-F, AIC0041-F, AIC0042-F, AIC0043-F, AIC0044-F, AIC0045-F, AIC0046-F, AIC0071-F, AIC0072-F, AIC0073-F, AIC0074-F, AIC0075-F, AIC0076-F, AIC0077-F, AIC0078-F, AIC0079-F, AIC0080-F		

DIN 9021



código	560117	referencia	12010267
descripción	arandela int.ø 6.4mm ø ext. 18mm espesor 1.5mm inox UE 20 pzs DIN 9021 para rosca M6		
Para modelos:	AIC0037-F, AIC0038-F, AIC0039-F, AIC0040-F, AIC0041-F, AIC0042-F, AIC0043-F, AIC0044-F, AIC0045-F, AIC0046-F, AIC0071-F, AIC0072-F, AIC0073-F, AIC0074-F, AIC0076-F, AIC0077-F, AIC0078-F		

otros



código	512509	referencia	9221747.00
descripción	arandela int.ø 8.4mm ø ext. 40mm espesor 2mm		
Para modelos:	VS7080BREI, VS7080BREIM, VS7080BRGI, VS7080BRGIM, VS9080BREI, VS9080BREIM, VS9080BRGI, VS9080BRGIM		

arandelas dentadas

DIN 6798A



código	560125	referencia	12009928
descripción	arandela dentada int.ø 4.2mm ø ext. 8mm inox DIN/ISO DIN 6798A UE 20 pzs para rosca M4		
Para modelos:	AIC0037-F, AIC0038-F, AIC0039-F, AIC0040-F, AIC0041-F, AIC0043-F, AIC0044-F, AIC0045-F, AIC0046-F, AIC0071-F, AIC0072-F, AIC0073-F, AIC0074-F, AIC0075-F, AIC0076-F, AIC0077-F, AIC0079-F, AIC0080-F		



código	560126	referencia	12009890
descripción	arandela dentada int.ø 5.2mm ø ext. 10mm inox DIN/ISO DIN 6798A UE 20 pzs para rosca M5		
Para modelos:	AIC0037-F, AIC0038-F, AIC0039-F, AIC0040-F, AIC0041-F, AIC0042-F, AIC0043-F, AIC0044-F, AIC0045-F, AIC0046-F, AIC0071-F, AIC0072-F, AIC0073-F, AIC0074-F, AIC0075-F, AIC0076-F, AIC0077-F, AIC0078-F, AIC0079-F, AIC0080-F		



código	560342	referencia	12009882
descripción	arandela dentada int.ø 6.5mm ø ext. 11mm inox UE 1 pzs para rosca M6		
Para modelos:	AIC0037-F, AIC0038-F, AIC0039-F, AIC0040-F, AIC0041-F, AIC0042-F, AIC0043-F, AIC0044-F, AIC0045-F, AIC0046-F, AIC0071-F, AIC0072-F, AIC0073-F, AIC0074-F, AIC0075-F, AIC0076-F, AIC0077-F, AIC0078-F, AIC0079-F, AIC0080-F		

sujeciones

abrazaderas

abrazaderas de tubo

DIN 3017 - W2



código	520117	referencia	12009962
descripción	abrazadera de tubo acero inoxidable ø 40-60mm ancho 9mm UE 5 pzs DIN 3017		
Para modelos:	AIC0037-F, AIC0038-F, AIC0039-F, AIC0040-F, AIC0041-F, AIC0042-F, AIC0043-F, AIC0044-F, AIC0045-F, AIC0046-F, AIC0071-F, AIC0072-F, AIC0073-F, AIC0074-F, AIC0075-F, AIC0076-F, AIC0077-F, AIC0078-F, AIC0079-F, AIC0080-F, GLB0067-F, GLB0069-F, GLB0071-F, GLB0080, GLB0081, GLB0082		



			
1			
código	520114	referencia	12010023
descripción	abrazadera de tubo ø 20-32mm ancho 9mm UE 10 pzs DIN 3017		
Para modelos:	AIC0037-F, AIC0038-F, AIC0039-F, AIC0040-F, AIC0041-F, AIC0042-F, AIC0043-F, AIC0044-F, AIC0045-F, AIC0046-F, GLB0069-F, GLB0071-F, GLB0080, GLB0081, GLB0082		

			
1			
código	520115	referencia	12009997
descripción	abrazadera de tubo ø 25-40mm ancho 9mm UE 10 pzs DIN 3017		
Para modelos:	AIC0037-F, AIC0038-F, AIC0039-F, AIC0040-F, AIC0041-F, AIC0042-F, AIC0043-F, AIC0044-F, AIC0045-F, AIC0046-F, GLB0067-F, GLB0069-F, GLB0081		

			
1			
código	520118	referencia	12009933
descripción	abrazadera de tubo ø 50-70mm ancho 9mm UE 5 pzs DIN 3017		
Para modelos:	GLB0067-F, GLB0069-F, GLB0081		

			
1			
código	520454	referencia	12009914
descripción	abrazadera de tubo ø 70-90mm ancho 9mm UE 5 pzs DIN 3017		
Para modelos:	AIC0045-F, AIC0046-F, AIC0075-F, AIC0080-F		

DIN 3017 - W4			
			
1			
código	520120	referencia	12010036 927322
descripción	abrazadera de tubo inox W4 ø 12-20mm ancho 9mm UE 1 pzs DIN 3017		
Para modelos:	AIC0037-F, AIC0038-F, AIC0039-F, AIC0040-F, AIC0041-F, AIC0042-F, AIC0043-F, AIC0044-F, AIC0045-F, AIC0046-F, GLB0043C-60Hz, GLB0067-F, GLB0069-F, GLB0071-F, GLB0080, GLB0081, GLB0082		

abrazaderas de alambre doble			
			
1			
código	560503	referencia	CFF10073
descripción	abrazadera de tubo ø 8-10mm espesor de hilo 1mm UE 1 pzs		
Para modelos:	GLB0043C-60Hz		

anillos truarc			
DIN 472			
			
1			
código	523106	referencia	12010122
descripción	anillo truarc taladro ø 28mm espesor 1.3mm acero DIN 472		
Para modelos:	AIC0037-F, AIC0038-F, AIC0039-F, AIC0040-F, AIC0041-F, AIC0042-F, AIC0043-F, AIC0044-F, AIC0045-F, AIC0046-F, AIC0071-F, AIC0072-F, AIC0073-F, AIC0074-F, AIC0075-F, AIC0076-F, AIC0077-F, AIC0078-F, AIC0079-F, AIC0080-F		

DIN 6799			
			
1			
código	691470	referencia	12010014
descripción	anillo truarc E D1 ø 8mm D2 ø 16mm inox DIN 6799 espesor 1mm para árbol ø 9-12mm		
Para modelos:	AIC0037-F, AIC0038-F, AIC0039-F, AIC0040-F, AIC0041-F, AIC0042-F, AIC0043-F, AIC0044-F, AIC0045-F, AIC0046-F, AIC0071-F, AIC0072-F, AIC0073-F, AIC0074-F, AIC0075-F, AIC0076-F, AIC0077-F, AIC0078-F, AIC0079-F, AIC0080-F		

pasadores elásticos			
			
1			
código	691725	referencia	12010273
descripción	pasador elástico ø 4.5mm L 15mm		
Para modelos:	AIC0037-F, AIC0038-F, AIC0039-F, AIC0040-F, AIC0041-F, AIC0042-F, AIC0043-F, AIC0044-F, AIC0045-F, AIC0046-F		

chavetas

1 

código	551305	referencia	12010292
descripción	chaveta ø 2mm L 23mm inox UE 20 pzs		
Para modelos:	AIC0043-F, AIC0044-F, AIC0045-F, AIC0046-F, AIC0074-F, AIC0075-F, AIC0079-F, AIC0080-F		

1 

código	358603	referencia	228011
descripción	fusible fino medida ø5x20mm 2A retardado nominal 250V UE 10 pzs		
Para modelos:	GLB0043C-60Hz, GLB0047		

1 

ø6,3x32mm 250V

código	358760	referencia	926283
descripción	fusible fino medida ø6,3x32mm 0,315A semi retardado nominal 250V UE 10 pzs		
Para modelos:	GLB0040, GLB0041, GLB0042, GLB0043C, GLB0044C, GLB0045, GLB0047, GLB0048		

1 

portafusibles

código	550519	referencia	H.228048
descripción	placa de cubierta fusible adaptableA nominalIV empalme para portafusibles		
Para modelos:	GLB0040, GLB0041, GLB0042, GLB0043C, GLB0044C, GLB0047, GLB0048		

1 

fusibles térmicos

código	358190	referencia	663.077.00
descripción	fusible térmico temp. desconexión 98°C		
Para modelos:	VS9080TPET, VS9080TPFE		

consumibles

fusibles

fusibles finos

1 

código	358530	referencia	926284
descripción	fusible fino medida ø5x20mm 0.8A rápido nominal 250V UE 10 pzs		
Para modelos:	GLB0040, GLB0041, GLB0042, GLB0043C, GLB0044C, GLB0045, GLB0047, GLB0048		

1 

código	358677	referencia	228004
descripción	fusible fino medida ø5x20mm 4A rápido nominal 250V UE 10 pzs		
Para modelos:	GLB0040, GLB0041, GLB0042, GLB0043C, GLB0043C-60Hz, GLB0044C, GLB0047, GLB0048		

1 

código	358594	referencia	228012
descripción	fusible fino medida ø5x20mm 0.16A retardado nominal 250V UE 10 pzs		
Para modelos:	GLB0043C-60Hz, GLB0047		

A			
abrazaderas	108, 112		
abrazaderas de alambre doble	108, 113		
abrazaderas de tubo	108, 112		
accesorios eléctricos	47		
anillos de junta	93		
anillos truarc	113		
aparatos de mando y aviso	19		
arandelas	112		
arandelas dentadas	112		
arandelas elásticas	111		
B			
barras DIN	49		
barras roscadas	111		
bisagras de resorte	83		
bisagras para hornos	84		
bombas	39		
bombas de aumento de presión I	44		
bombas de aumento de presión II	45		
bombas de lavado y aclarado	39		
bombas de salida	44		
boquillas de gas	63		
C			
cables	47		
cables de alimentación aparatos	47		
cables de calefacción	5		
cables de cinta plana	47		
caños de pared	102		
cartuchos calentadores	5		
casquillos de inmersión	15		
chavetas	114		
cierres angulares	82		
cierres de palanca	82		
cierres de pestillo espagnolette	83		
clips para bulbo	15		
componentes para el circuito agua	107		
componentes para el circuito frigorífico	96		
compresores	34		
condensadores de servicio	45		
condensadores y filtros antiparasitarios	45		
conmutadores de levas	17		
consumibles	114		
contactores	21		
controladores electrónicos	25		
cordones de junta	95		
D			
dosificadores	100		
E			
electródos	33		
empalmes de tubo	106		
empalmes de tubos	106		
encendedores piezoeléctricos	57		
enrolladores de mangueras para aparatos	100		
enrolladores de tubo	100		
evaporadores	96		
F			
filtros	46		
filtros deshidratadores antiácidos	96		
filtros de recipientes	101		
flujómetros	34		
fusibles	46, 114		
fusibles finos	114		
fusibles térmicos	114		
G			
grifos de gas	50		
H			
herramientas	108		
herramientas de limpieza	108		
I			
interruptores de encendido	58		
interruptores magnéticos	18		
interruptores pulsantes y pulsadores	15		
interruptores y pulsadores	15		
interruptores/pulsadores basculantes	15		
J			
juntas de árbol	95		
juntas de gomaespuma	94		
juntas de puerta para lavavajillas	95		
juntas insertables	91		
juntas para bandejeros	92		
juntas para frigoríficos	91		
juntas para puertas	91		
juntas para brazos de lavado	95		
juntas térmicas	91		
juntas tóricas	92		
L			
lámparas	19		
lámparas de señalización	19		
lámparas de señalización completas	20		
lámparas halógenas	21		
lámparas para hornos	21		
LEDs	20		

M

material de sujeción	109
microinterruptores	16
motores	39
motores de aire caliente	37
motores refrigeración universales	36

P

parrillas	89
pasacables	47
pasadores elásticos	113
pesas para filtros	101
pilotos de encendido	53
placas de cocción	11
presostatos	32

Q

quemadores de cocina	59
quemadores de gas	59
quemadores para placas radiantes	62
quemadores tubulares	60, 62

R

racores para cables	47
radiadores cerámicos	6
reductores de presión	107, 107
reguladores de energía	11
rejillas y rieles guía	89
relés	24
remaches/tuercas de remache	109
resistencias	3
resistencias circulación de aire	8
resistencias de descongelación	4
resistencias de inmersión	6
resistencias de tubo de aletas	6
resistencias para baño maría	3
resistencias para cuecepaste	4
resistencias para formadoras de pizzas	5
resistencias para freidora	3
resistencias para hornos	3
resistencias para plancha grills	4
resistencias para refrigeración	4
resistencias para sartenes basculantes	4
resistencias radiantes	8
resortes de fijación	15
ruedas para aparatos y esquinas protectoras	88

S

sensores	26
sensores universales	26
sondas de temperatura	26
sopletes	62

sujeciones	112
------------	-----

T

terminales	48
termopares	58
termostatos	11
termostatos de regulación	12
termostatos de seguridad	13, 14
termostatos de superficie	11
termostatos de superficie de seguridad	11
termostatos para gas	51
tornillos	109
tornillos de cabeza avellanada	109
tornillos de cabeza cilíndrica	110
tornillos de cabeza de gota de sebo	110
tornillos de cabeza plana	109
tornillos prisioneros	111
transformadores	25
tuberías de gas	63
tubos de entrada	107
tubos de presostato	103
tubos de salida	103
tubos de silicona	104
tubos flexibles	102
tubos flexibles de entrada	102
tubos flexibles de entrada de PVC	102
tubos flexibles de gas	63
tubos flexibles de PVC	104
tubos flexibles industriales	103
tubos formados	104
tubos Niplaflex	103
tuercas	111
tuercas hexagonales	110, 111

U

unidades condensadoras	34
unidades de encendido	58

V

válvulas de bola	107
válvulas de cierre	107
válvulas de control de gas	52
válvulas de entrada	107
válvulas magnéticas	30
válvulas y caños de pared	107
ventilador axial	35
ventiladores	35
ventiladores de refrigeración	37, 37
ventiladores para frigoríficos	36
ventiladores radiales	38
ventiladores tangenciales	37