



**GAS COMPONENTS**



**ELECTRIC COMPONENTS**



**WATER TECHNOLOGY**



**MECHANICAL COMPONENTS**



**TOOLS**

Spare parts suitable for

**VULCAN**

Find the complete and up-to-date range of products in our GEV Webshop



# Manufacturer catalogue

The most important spare parts and accessories arranged clearly for every manufacturer

- ✓ Complete product range and all appliance data always up to date in the GEV Webshop
- ✓ Alphabetical Index at the end of the catalogue

## GEV Webshop

[www.gev-online.co.uk](http://www.gev-online.co.uk)

[www.gev-online.com](http://www.gev-online.com)



- 🔍 Add to Favourites
- 🔍 Sign In with email address and usual password
- 🔍 Easy-order – place several items in your basket at the same time
- 🔍 Quick Item search – no login needed



## switches and momentary switches

### rocker/momentary rocker switches

37x21mm



1

<b>GEV No.</b>	348098 <sup>1</sup>	<b>Ref. No.</b>	00-358628-00001 358628-00001 358628-1
<b>description</b>	rocker switch mounting measurements 37x21mm black 2CO 250V 10A with neutral position connection male faston 6.3mm ambient temperature max. 125/55°C protection IP55		

<sup>1</sup>with neutral position

## lamps

### indicator lights

#### indicator lights (complete)

ø12mm

with plug-in socket



1

<b>GEV No.</b>	580014	<b>Ref. No.</b>	843808 844367-7
<b>description</b>	indicator light ø 12mm 230V red		

## contactors

### HARTLAND

#### power contactors

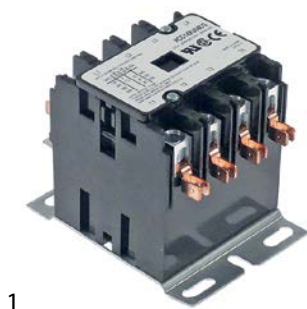

1

<b>GEV No.</b>	580012	<b>Ref. No.</b>	111497D3 411497D3 844329 853270
<b>description</b>	contactor resistive load 50A 240VAC 40A/10HP (AC3/240V) 40A/7.46kW main contacts 4NO connection screw clamp/male faston 6.3mm type HCCY4XU04CG		

## gas valves and ignition boxes





### gas control valves

#### ROBERTSHAW

##### electric controlled valves



1

<b>GEV No.</b>	101429	<b>Ref. No.</b>	470841-3
<b>description</b>	gas valve 120V 50/60Hz gas inlet 3/4" gas outlet 3/4" thermo-couple connection 3/8" NEF pilot connection 1/4" pipe US type 7000BMSER-120 pressure controller natural gas 3.5" W.C. suitable for ROBERTSHAW		
<b>spare parts for</b>	101429		
	<b>GEV No.</b>	101047	<b>Ref. No.</b> —
	magnet unit T1: ASA 11/32 T2: M24x1 L 59mm ø 4mm suitable for ROBERTSHAW		
	<b>GEV No.</b>	101389	<b>Ref. No.</b> —
	pressure controller natural gas suitable for ROBERTSHAW		
	<b>GEV No.</b>	580033	<b>Ref. No.</b> —
	knob suitable for ROBERTSHAW		
<b>accessories for</b>	101429		
	<b>GEV No.</b>	580035	<b>Ref. No.</b> 110839-1 410839-1
	thermopile L 36" - 915mm probe ø 9mm probe L 38mm 250-750mV screw connection 7/16" connection 3/8" NEF		

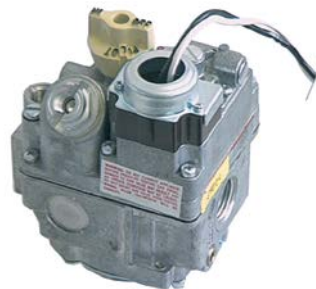

1







<b>GEV No.</b>	580044	<b>Ref. No.</b>	110841-3 410841-00003 410841-3
<b>description</b>	gas valve supply 120VAC 50/60Hz gas inlet 3/4" NPT gas outlet 3/4" NPT thermocouple connection 11/32" pilot connection 1/4" CCT type 7000BER-120 pressure controller natural gas 3.5" W.C. suitable for ROBERTSHAW		
<b>spare parts for</b>	580044		
	<b>GEV No.</b>	101047	<b>Ref. No.</b> —
	magnet unit T1: ASA 11/32 T2: M24x1 L 59mm ø 4mm suitable for ROBERTSHAW		
	<b>GEV No.</b>	101389	<b>Ref. No.</b> —
	pressure controller natural gas suitable for ROBERTSHAW		





Table continues overleaf



<b>spare parts for</b> 580044			
	GEV No.	106109	Ref. No. —
	locking screw thread 7/16"-24 UNS for pipe ø 1/4" L 16mm brass Qty 1 pcs WS 7/16" (11.113mm) hole ø 6.4mm		
	GEV No.	580033	Ref. No. —
	knob suitable for ROBERTSHAW		
<b>accessories for</b> 580044			
	GEV No.	102122	Ref. No. —
	thermocouple ROBERTSHAW ASA 11/32 L 18" - 455mm 7/16"		
	GEV No.	102277	Ref. No. —
	thermocouple ROBERTSHAW ASA 11/32 L 36" - 915mm 7/16"		

gas controlled valves



<b>GEV No.</b>	580043	<b>Ref. No.</b>	110841-1 410841-1
<b>description</b>	gas valve supply Operator gas inlet 1/4" CCT outlet 1/4" CCT gas inlet 3/4" NPT gas outlet 3/4" NPT thermocouple connection 3/8" NEF pilot connection 1/4" CCT type 7000BMSGOR pressure controller natural gas 3.5" W.C. suitable for ROBERTSHAW		
<b>spare parts for</b> 580043			
	GEV No.	101042	Ref. No. —
	magnet unit T1: 3/8" NEF suitable for ROBERTSHAW for gas operator		
	GEV No.	101481	Ref. No. —
	olive for pipe ø 1/4" CCT Qty 1 pcs		
	GEV No.	106109	Ref. No. —
	locking screw thread 7/16"-24 UNS for pipe ø 1/4" L 16mm brass Qty 1 pcs WS 7/16" (11.113mm) hole ø 6.4mm		
	GEV No.	580033	Ref. No. —
	knob suitable for ROBERTSHAW		
<b>accessories for</b> 580043			
	GEV No.	580035	Ref. No. 110839-1 410839-1
	thermopile L 36" - 915mm probe ø 9mm probe L 38mm 250-750mV screw connection 7/16" connection 3/8" NEF		

ignition parts

pilot burners

ROBERTSHAW

pilot burners

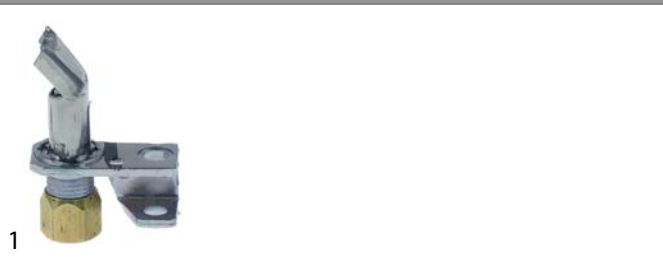

universal series - type 2



<b>GEV No.</b>	107402	<b>Ref. No.</b>	109839-1 109839-3 409839-1 409839-3 409839-3 (LP) / 409839-1 (NAT)
<b>description</b>	pilot burner ROBERTSHAW type 2C-2 1 flame natural/liquid gas code 18/10 for pipe ø 1/4" CCT		



<b>GEV No.</b>	100117	<b>Ref. No.</b>	112787-1 412787-1 412787-1 (NAT)
<b>description</b>	pilot burner ROBERTSHAW type 2CH-1 1 flame natural gas code 18 for pipe ø 1/4" CCT		

<b>accessories for</b> 100117			
	GEV No.	100275	Ref. No. 109839-6
	pilot burner nozzle LPG code 10 bore ø 0.1mm suitable for ROBERTSHAW		
	GEV No.	100276	Ref. No. —
	pilot burner nozzle natural gas code 18 suitable for ROBERTSHAW		
	GEV No.	100277	Ref. No. —
	pilot burner nozzle natural gas code 26 suitable for ROBERTSHAW		
	GEV No.	101286	Ref. No. —
	olive ID ø 6mm Qty 1 pcs		
	GEV No.	101481	Ref. No. —
	olive for pipe ø 1/4" CCT Qty 1 pcs		
	GEV No.	101483	Ref. No. —
	union nut thread 1/4" CCT short		







universal series - type 3

			
1			
<b>GEV No.</b>	107398	<b>Ref. No.</b>	112082-1 112082-2 412082-1 412082-1 (NAT) / 412082-2 (LP)
<b>description</b>	pilot burner ROBERTSHAW type 3CH-10 2 flames natural/liquid gas code 16/10 for pipe ø 1/4" CCT		
<b>spare parts for</b>	107398		
	<b>GEV No.</b>	100275	<b>Ref. No.</b> 109839-6
pilot burner nozzle LPG code 10 bore ø 0.1mm suitable for ROBERTSHAW			
	<b>GEV No.</b>	106105	<b>Ref. No.</b> —
pilot burner nozzle LPG code 16 suitable for ROBERTSHAW			

universal series - type 6

Width of caps:  
 6CH10 = 1" (25,4mm)  
 6CH14 = 1½" (38,1mm)  
 6CH24 = 2½" (63,5mm)  
 6CH30 = 3" (76,2mm)

			
1			
<b>GEV No.</b>	106346	<b>Ref. No.</b>	112212-1 412212-1
<b>description</b>	pilot burner ROBERTSHAW type 6CH14-10 3 flames natural gas code 22 for pipe ø 1/4" CCT gas connection 1/4" CCTmm		

			
1			
<b>GEV No.</b>	107396	<b>Ref. No.</b>	805925-11 F5925-11
<b>description</b>	pilot burner ROBERTSHAW type 6CH24-6 3 flames natural/liquid gas code 16/26 for pipe ø 1/4" CCT		
<b>spare parts for</b>	107396		
	<b>GEV No.</b>	100277	<b>Ref. No.</b> —
pilot burner nozzle natural gas code 26 suitable for ROBERTSHAW			
	<b>GEV No.</b>	106105	<b>Ref. No.</b> —
pilot burner nozzle LPG code 16 suitable for ROBERTSHAW			

11EA series

			
1			
<b>GEV No.</b>	107412	<b>Ref. No.</b>	00-409125-0001 00-409125-0003 109125-1 109125-3 409125-1 409125-3 729125-1 729125-3
<b>description</b>	pilot burner ROBERTSHAW type 11EA 1 flame natural gas for pipe ø 3/16" - 1/4" CCT		

Mini Pilot series

			
1			
<b>GEV No.</b>	107414	<b>Ref. No.</b>	2693 802693
<b>description</b>	pilot burner ROBERTSHAW type 2 2 flames natural/liquid gas code for pipe ø 3/16" - 1/4" CCT with thermocouple		

producer-specific pilot burners

VULCAN HART

			
1			
<b>GEV No.</b>	107391	<b>Ref. No.</b>	00-410662-000G1 110662G1 112071G1 112073G1 113866G1 410662G1 412071G1 412073G1 421573G4
<b>description</b>	pilot burner 4 flames 3/16"		



1

<b>GEV No.</b>	107413	<b>Ref. No.</b>	00-414645-0001 114645-1 414645-1
<b>description</b>	pilot burner type 43U4		

**thermocouples**

**thermocouple sets universal**



1

<b>GEV No.</b>	102281	<b>Ref. No.</b>	00-412788-0001 112788-1 20040 412788-1 920040
<b>description</b>	thermocouple set ROBERTSHAW 5-piece L 24" - 610mm		



1

<b>GEV No.</b>	103236	<b>Ref. No.</b>	00-722248
<b>description</b>	thermocouple set ROBERTSHAW 5-piece L 60" - 1525mm ASA 11/32		

**thermopiles**

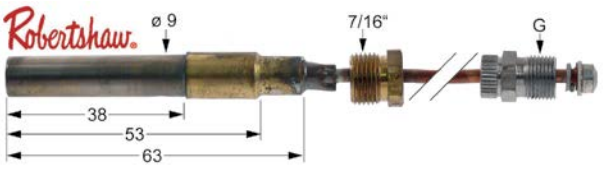

1

<b>GEV No.</b>	580035	<b>Ref. No.</b>	110839-1 410839-1
<b>description</b>	thermopile L 36" - 915mm probe $\varnothing$ 9mm probe L 38mm 250-750mV screw connection 7/16" connection 3/8" NEF		

**accessories**

**interrupters**



1

<b>GEV No.</b>	580046	<b>Ref. No.</b>	00-410838-000G1 110838G1 410838G1
<b>description</b>	extension for interruptor L 18" - 455mm		

**gas nozzles**

**pilot burner nozzles**

**pilot burner nozzles ROBERTSHAW**



1

<b>GEV No.</b>	100275	<b>Ref. No.</b>	109839-6
<b>description</b>	pilot burner nozzle LPG code 10 bore $\varnothing$ 0.1mm suitable for ROBERTSHAW		

**hinges**

**overlying hinges**

**miscellaneous**

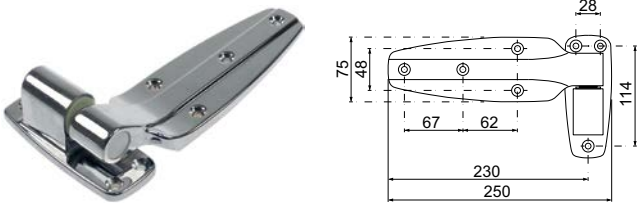

1

<b>GEV No.</b>	701446	<b>Ref. No.</b>	138057-14 430900-1-5
<b>description</b>	hinge overall height 54mm with gradient total length 250mm W 75mm		

**baskets**

**fryer baskets**

**US producers**



1

<b>GEV No.</b>	970183	<b>Ref. No.</b>	OY420563-1
<b>description</b>	fryer basket L1 308mm W1 160mm H1 135mm		



			
1			
<b>GEV No.</b>	970184	<b>Ref. No.</b>	110782-1 111378-2 410782-1 411378-2 420581-1 4900
<b>description</b>	fryer basket L1 330mm W1 315mm H1 135mm		

			
1			
<b>GEV No.</b>	970182	<b>Ref. No.</b>	108654-1 110737-1 110737-7 408654-1 410737-1 410737-7 4712 804712
<b>description</b>	fryer basket L1 340mm W1 165mm H1 150mm L2 620mm H2 280mm		





**C**

contactors 3

**G**

gas control valves 3

gas nozzles 6

**I**

indicator lights 3

indicator lights (complete) 3

**L**

lamps 3

**O**

overlying hinges 6

**P**

pilot burners 4

**R**

rocker/momentary rocker switches 3

**S**

switches and momentary switches 3

**T**

thermocouples 6