

# Defrosting Timers

## D53 (SB3)

### Defrost Timers



#### Technical Data

##### Supply voltages

Standard: 220/240 V. (+10% - 15%)  
On request: 24 V. 110/120 V.

##### Supply frequency

Standard: 50 Hz  
Or 60 Hz.

##### Operating temperature

-10°/+55°C.

##### Contact rating

16(6) A – 250 vac.

##### Absorbed power

3,5 W max.

##### Electrical connections

Faston terminals 6,35 mm x 0,8 mm.

##### Operating position

Any.

##### Mounting

Standard: on panel – 2 screws  $\phi$  4 mm  
On request: on din 35 rail with adaptor code 021B0300000 (optional).

##### Defrost Cycles Selection

From 1 to 12 per day.

##### Defrost Time

Adjustable from 1 to 56 minutes.

##### Fan Delay

Adjustable from 0 to 15 minutes  
(Only for model D53.82).

##### Mod. D53.81

Defrost with resistor.

##### Mod. D53.82

Defrost with fan delay

##### Mod. D53.92

End of defrost cycle controlled by a thermostat(not supplied) with safety time in case of thermostat failure

##### Approvals

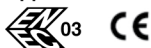

##### Declaration of conformity

ROHS (Directive 2002/95/CE)

#### Applications

For automatic defrosting of industrial refrigeration plant, commercial viscoolers and display counters.

#### Features

- From 1 to 12 defrost cycles per day thanks to non detachable tabs.
- Defrost time easily adjustable from 1 to 56 minutes.
- Fan delay easily adjustable from 0 to 15 minutes (for D53.82).
- Independent power supplies for synchronous motor and for switches.
- High contact rating (SPDT).
- Safety guard for wiring terminals in accordance with CEI 23 – 11.

#### Overall dimensions

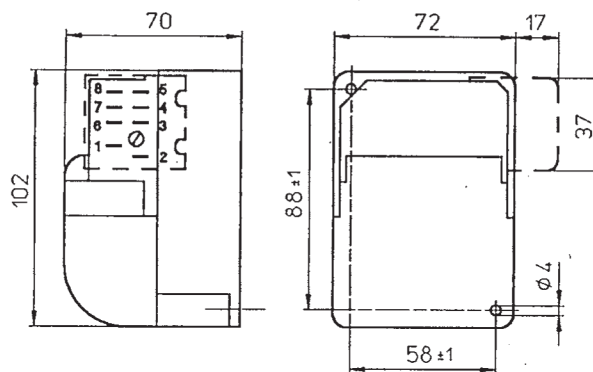

#### Optional

##### PANEL MOUNTING

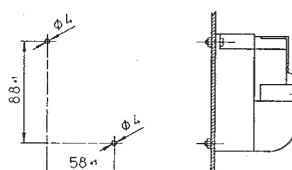

##### DIN RAIL MOUNTING

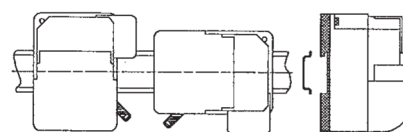

#### Ordering code

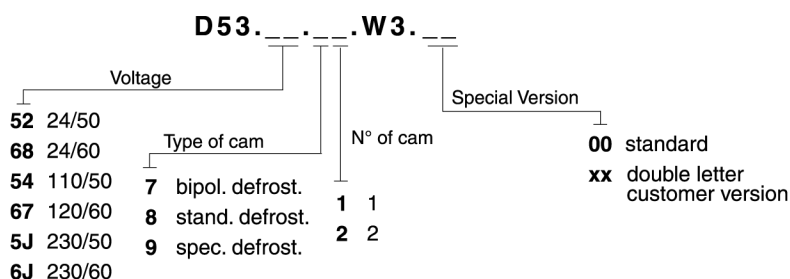

# Defrosting Timers

D53 (SB3)



## Connection and operating diagrams

### Electrical Connection protection:

the cover, supplied not fastened, must be positioned and fastened with the screw after wiring.  
NB: The slots for the passage of the wires can be widened removing the pre-cut central sector.

### Timing:

see fig. 1 - switching intervals:  
T1 and T2 adjustable (T1+T2=60 mins max)  
T3 fixed (only type SB3.92).  
Type SB3.72: the two contacts switch simultaneously.  
From 1 to 12 defrosts per day.

### Typical Applications:

see fig. 2.1: defrosting with hot gas.  
see fig. 2.2: defrosting with fan delay.  
see fig. 2.3: defrosting with resistor.  
see fig. 2.4: defrost termination by thermostat with safety reset if thermostat fails.

### Wiring: see fig. 2

C = cooling  
D = defrosting  
V = reverse cycle valve  
TD = defrost termination thermostat  
T = cooling thermostat  
R = relay  
F = fan

fig. 1

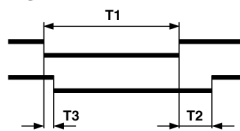

mod./type	T1	T2	T3
SB3.81	1...58 min	-	-
SB3.72	2...64 min	0	0
SB3.82	1...56 min	0...15 min	0
SB3.92	2...54 min	0	2 min
tot.	± 25 sec	± 30 sec	± 10 sec

fig. 2

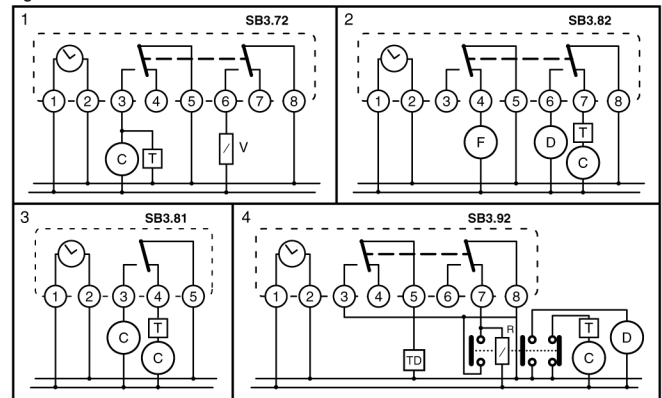

## Setting

### Programme setting:

See fig. 3 - Set defrost period T1 by aligning pointer (G) of the cam (B) to number of wanted minutes of graduation visible into window (C).  
Turning the transparent dial of hours (D) align the wanted time of defrosting start to point (E) of cam (B).

### Time setting:

See fig. 3 - Turn knob (F) clockwise until tip of actuator (A) aligns with the actual time on transparent hour dial (D).

### Example

T1 = 30 mins - Two defrosts per day, at 9.00 hrs and 21.00 hrs - Actual time = 16.00 hrs.

- Two defrosts per day are obtainable with type ...-12H.
  - Pointer (G) on nick 30 of graduation (C)
  - Nick 9 of dial of hours (D) aligned to point (E) of cam (B).
  - Tip of actuator (A) aligned to nick 4 of the transparent dial (D).
- NB: on the type 4H, 6H and 12H the PM hrs corresponds to AM hrs.

