

☉ Registradores de datos **CAMRegis**
CAMRegis data loggers
Enregistreurs de données **CAMRegis**
CAMRegis-Datenschreiber

Ⓔ Manual de usuario
Ⓔ User Manual
Ⓔ Manuel d'utilisation
Ⓔ Benutzerhandbuch



AKO-15740 AKO-15742
AKO-15750 AKO-15752

Contents	Page
Chapter 1: Presentation	20
1.1 Versions and references	20
1.2 Maintenance	20
1.3 Precautions	20
Chapter 2: Description	21
2.1 Keyboard functions	21
Chapter 3: Operation	22
3.1 Display modes	22
3.2 Fast printing	23
3.3 User menu	23
Chapter 4: Setting and configuration	26
4.1 Logger	26
4.2 Language	27
4.3 Input wizard	27
4.4 Contrast	28
4.5 Logged data	29
4.6 Inputs	29
Chapter 5: Connectivity	30
5.1 Without a PC	30
5.2 With PC or AKO-5005	31
Chapter 6: Changing the thermal paper roll	32
Chapter 7: Frequently asked questions	33

AKO Electromecànica thanks and congratulates you for purchasing our product, in whose development and manufacture the most innovative technology has been used, as well as strict production and quality control processes.

Our commitment to satisfy our customers and our continuous efforts to improve every day can be seen in the various quality certifications we have obtained.

This is a high performance, high technology product. The operation and final performance of the equipment depend on proper planning, installation, configuration and commissioning. Read this manual carefully before installation, and always follow its instructions.

Only qualified personnel should install or perform technical assistance on this product.

This product is designed to be used in the applications described in the product manual. AKO Electromecànica gives no guarantee of its operation in any use not foreseen in the manual, and is not responsible for any damage resulting from improper use, configuration, installation or commissioning.

It is the responsibility of the installer and the customer to comply with and ensure others comply with all regulations applicable to installations incorporating our products. AKO Electromecànica is not responsible for any damage caused by non-compliance with regulations. Follow strictly the instructions given in this manual.

To maximise the service life of our equipment, these recommendations should be followed:

- Do not expose electronic equipment to dust, dirt, water, rain, humidity, high temperatures, chemicals or corrosive substances of any sort.

- Do not submit the equipment to blows or vibrations or try to manipulate it differently from shown in the manual.

- Never exceed the specifications and limitations indicated in the manual.

- Always respect the specified ambient working and storage conditions.

- During and after installation, avoid leaving loose, broken, unprotected or damaged wiring, since they might constitute a risk for the equipment and its users.

AKO Electromecànica reserves the right to make any modification to the documentation or the equipment without previous notice.

1.- Presentation

CAMRegis is a solution for capturing, storing and recording temperatures and other physical variables such as humidity and pressure.

They have an internal memory that can store up to 6 years' data, recording every 30 minutes, and a battery that provides up to 6 hours' autonomy recording data + up to 3 months' maintaining of date and time in the event of a failure of the electrical supply.

The data stored can be displayed on screen or printed by means of the unit's own printer (depending on the model).

These units can be connected to each other creating networks of up to 7 loggers (1 master + 6 slaves) or connected to a PC (master), creating a network of up to 127 units (slaves).

From the master (PC or logger) the data of any slave can be displayed and printed.

1.1.- Versions and references

MODELS	INPUTS	PRINTER	RELAYS (250V, cos φ=1)	POWER SUPPLY
AKO-15740	10	NO	Max. alarm: 8A SPDT Max. alarm: 8A SPDT	100 - 240 Vac 50/60 Hz ± 3 Hz
AKO-15742	10	YES		
AKO-15750	5	NO		
AKO-15752	5	YES		

Software included: SOFTRegis

1.2.- Maintenance

Clean the surface of the alarm using a soft cloth, soap and water. Do not use abrasive detergents, petrol, alcohol or solvents.

Units that incorporate rechargeable electrical accumulators:

This unit has built-in accumulators which must be replaced when the autonomy of the unit is less than the duration shown in the specifications. At the end of the unit's life, the accumulators must be taken to a selective disposal centre or returned to the equipment manufacturer.

Periodic checks:

In accordance with standard **UNE EN 12830**, maintenance must include the checks indicated in the **UNE EN 13486** standard (only with the NTC probes supplied with the unit).

1.3.- Precautions

Using the logger contrary to the manufacturer's instructions may affect the device's safety requirements. To ensure that the device operates correctly only probes supplied by AKO should be used.

Between -40 °C and +20 °C, if the NTC probe is extended to up to 1,000 m with minimum 0.5 mm² wire, the maximum deviation will be 0.25 °C (wire for probe extension ref. **AKO-15586**).

The graph paper is thermal and therefore if you wish to keep the graphs for a long time you must make photocopies. The length of an input's graph is less than the length of a sheet of DIN A4.

With the recording frequency or interval set to 15 minutes, the loggers keep the information in memory for over one year. They therefore ensure compliance with **UNE EN 12830**, enabling graphs to be printed or displayed when required.

If frequencies of less than 15 minutes are configured, in order to comply with **UNE EN 12830**, the graphs must be printed before the memory ends and be kept for one year.

2.- Description

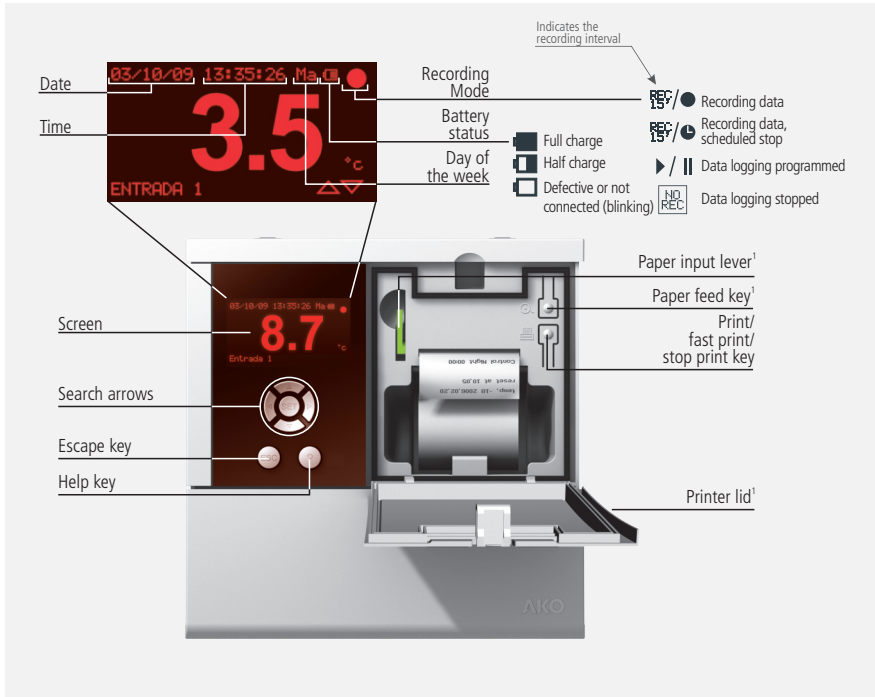

2.1 Keypad functions

- Horizontal scrolling. Changes display modes.
- Vertical scrolling/Change value. Changes the input to be displayed.
- Confirms selection
- Allows you to exit without saving changes (Programming). Returns to the previous menu or exits programming.
- Displays the help text for the parameter or function selected.

NOTE: The alarms are silenced by pressing any of the above keys.

On models with printer.

On each press, the paper advances approximately 1 cm.

On standby, prints the graph of the last calendar week logged.²
From the logger menu, prints the data or the graph shown on the screen.
From the alarm menu, prints the alarm log.
Stops any printing in progress.

¹ Only models **AKO-15742** and **AKO-15752**

² If the recording interval is 15'.

3.- Operation

3.1.- Display modes

There are four possible modes for displaying instantaneous input readings. Press ◀ or ▶ to toggle between the various modes:

Individual input information

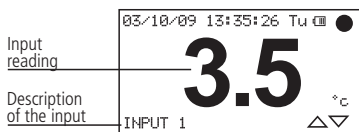

Displays the reading of a certain input on full screen. Press ▲ or ▼ to change the input to be displayed.

Sequential input information

Displays on full screen the reading of all active inputs one after the other.

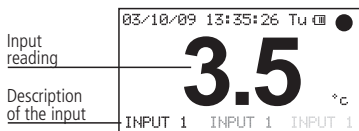

List of inputs

Displays a list of all the unit's inputs (whether active or not) and their readings. To scroll through the list, press ▲ or ▼.

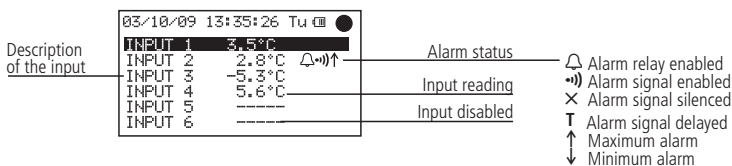

Summary of inputs (only AKO-15740 and AKO-15742)

Displays a summary of the readings of all inputs whether active or not (does not display the description).

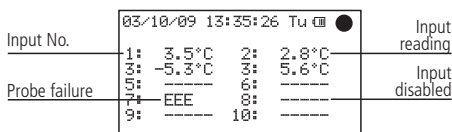

3.2.- Fast printing (only AKO-15742 and 15752)

When the  key is pressed the fast printing function is executed. This function prints the graphs of all the active inputs, with the data logged during the last period.

This period cannot contain gaps in continuity and its length is defined by the recording interval, as set out in the following table:

Recording interval	Period to be printed
1 min.	672 min. (11 hours)
5 min.	3.360 min. (56 horas)
15 min.	Last complete calendar week (From Sunday to Sunday)
30 min.	14 days

A gap in continuity is caused every time recording is stopped, or every time we make any change in the unit's configuration that affects the date/time parameters, description of inputs, measuring units, input type or recording interval.

If it does not have sufficient data saved, the unit will display the message "*Insufficient data to print graphic*" and will print the most recent data logged since the last change in configuration.

3.3.- User menu

The user menu allows you to access the unit's most frequently used functions. Press the **SET** key to enter.

Use the ◀ or ▶ keys to scroll through the various options and press **SET** to access them.

3.3.1.- Logger

Allows you to display or print the data logged during the time period selected.



Obtaining logged data.

August 2009						
Mo	Tu	We	Th	Fr	Sa	Su
					1	2
3	4	5	6	7	8	9
10	11	12	13	14	15	16
17	18	19	20	21	22	23
24	25	26	27	28	29	30
31						

Use the ▲ or ▼ keys to scroll through complete weeks.

Use the ◀ or ▶ keys to scroll through single days.

To select several consecutive days, press ? to fix the start and extend the selection with the ▶ key (maximum 7 days).

Once the selection is defined, press **SET**. Three options appear:

-Displaying data

Displays on the screen the data recorded during the selected period of the first active input.

Input displayed	INPUT 1	
Date of the recording	27/08/09 12:15:00	Recording value
Time of the recording	27/08/09 11:45:00	Recording value
	27/08/09 11:15:00	Recording value
	27/08/09 11:00:00	Recording value
	27/08/09 10:45:00	Recording value
	27/08/09 10:30:00	Recording value
	27/08/09 10:15:00	Recording value
	27/08/09 10:00:00	Recording value
	27/08/09 09:45:00	Recording value
	27/08/09 09:30:00	Recording value
	27/08/09 09:15:00	Recording value
	27/08/09 09:00:00	Recording value
	27/08/09 08:45:00	Recording value
	27/08/09 08:30:00	Recording value
	27/08/09 08:15:00	Recording value
	27/08/09 08:00:00	Recording value
	27/08/09 07:45:00	Recording value
	27/08/09 07:30:00	Recording value
	27/08/09 07:15:00	Recording value
	27/08/09 07:00:00	Recording value
	27/08/09 06:45:00	Recording value
	27/08/09 06:30:00	Recording value
	27/08/09 06:15:00	Recording value
	27/08/09 06:00:00	Recording value
	27/08/09 05:45:00	Recording value
	27/08/09 05:30:00	Recording value
	27/08/09 05:15:00	Recording value
	27/08/09 05:00:00	Recording value
	27/08/09 04:45:00	Recording value
	27/08/09 04:30:00	Recording value
	27/08/09 04:15:00	Recording value
	27/08/09 04:00:00	Recording value
	27/08/09 03:45:00	Recording value
	27/08/09 03:30:00	Recording value
	27/08/09 03:15:00	Recording value
	27/08/09 03:00:00	Recording value
	27/08/09 02:45:00	Recording value
	27/08/09 02:30:00	Recording value
	27/08/09 02:15:00	Recording value
	27/08/09 02:00:00	Recording value
	27/08/09 01:45:00	Recording value
	27/08/09 01:30:00	Recording value
	27/08/09 01:15:00	Recording value
	27/08/09 01:00:00	Recording value
	27/08/09 00:45:00	Recording value
	27/08/09 00:30:00	Recording value
	27/08/09 00:15:00	Recording value
	27/08/09 00:00:00	Recording value

To scroll through logs: ▲ ◯ ▼
 To scroll through inputs: ◀ ◯ ▶

-Displaying a graph

Displays on the screen the graph of the first active input with the data logged during the period selected.

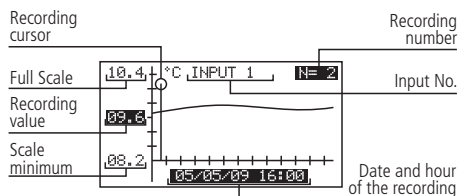

To scroll through records: ◀ or ▶
To scroll through inputs: ▲ or ▼
Printing the graph displayed:
(only AKO-15742 and 15752).

-Fast printing (only AKO-15742 and 15752).

Prints the graph of all the active inputs with the data recorded during the selected period.

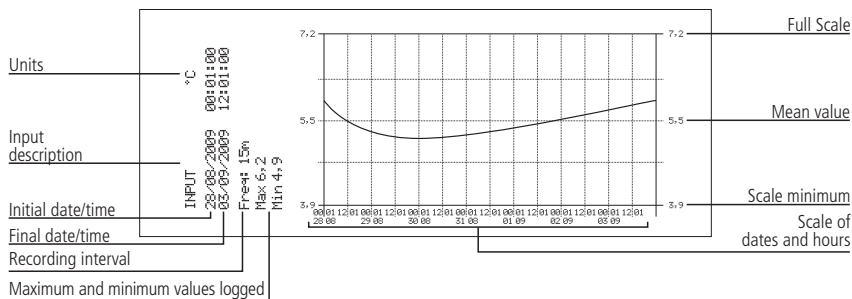

NOTES:

- If the period selected does not have sufficient data to display a graph, the unit will display the message "Insufficient data stored".
- You cannot select a date later than the current date or a week later than the current week.

3.3.2.- Alarms



Summary of alarms logged

Alarms:			
0-27/08/09	10:16	↑01	
1-29/08/09	02:45	↓09	
2-31/08/09	21:30	↑03	
3-05/10/09	14:55	↑05	
4-18/12/09	23:30	↓08	
5-19/12/09	23:50	↑03	

Displays a summary of the last 6 alarms logged by the unit.

The first alarm will be displayed in position 0, the second in 1 and so on until the six are completed. Once they are all complete, the new alarms will replace the previous ones following the same order.

Alarms:			
Alarm date	0-27/08/09	10:16	↑01
Alarm time	1-29/08/09	02:45	↓09
	2-31/08/09	21:30	↑03
	3-05/10/09	14:55	↑05
	4-18/12/09	23:30	↓08
	5-19/12/09	23:50	↑03

Print summary:
(only AKO-15742 and 15752)

↑ Maximum alarm
↓ Minimum alarm

3.3.3.- Recording mode

 Allows you to start, stop or programme the recording of data.

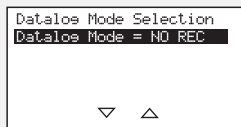

The unit has three operating modes:



Recording stopped (NO REC)

The unit displays the data of the active inputs but does not record them.



Recording started (REC)

The unit is currently recording the data of the active inputs.



Timed recording

The recording of data has been timed. The unit will start to record when the programmed start date and time are reached. It is also possible to time set the stopping of recording.

To change from one mode to another, access this option again, select the appropriate option with the ▲ or ▼ keys and press the **SET** key.

If you are in data recording mode when you access this option, the unit will request confirmation to stop the recording. Select the appropriate option and press **SET**.

In the timed recording option, scroll with the ◀ or ▶ keys to access the various options and use the ▲ or ▼ keys to change the values. Press **SET** to confirm

Case 1: Programmed start

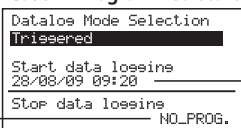

Non-programmed end of recording

Case 2: Programmed start and stop

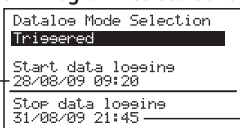

Date/time of end of recording

Date/time of start of recording

To scroll through values: ◀ ▶
To change values: ▲ ○ ▼
To confirm changes: **SET**

3.3.4.- Printer menu



Allows you to access the printer menu

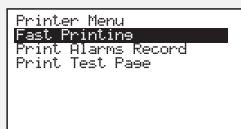

Select the appropriate option with the ▲ or ▼ keys and press the **SET** key.

Fast printing: Performs the same function as the  key as detailed in point 3.2 of this manual.

Print alarms record Prints a summary of the last 6 alarms recorded by the unit. (see point 3.3.2)

Print test page: Prints a test page to check the printer is working correctly.

4.- Setting and configuration

To access the programming menu, press the **SET** key for 5 secs.
If you have defined a password you must enter it and press **SET** again.

4.1- Logger



Parameters related to the logger's configuration.

```
System Configuration:
Time Zone
Winter/Summer Schedule
Date/Time
Recording Interval
Access Password
Clear data log
Master/Slave Mode:
```

Time zone:

Select the time zone in which the unit is installed.

Winter/Summer Schedule:

Changes the time setting from summer to winter and vice versa or allows you to select automatic execution of this change (only in the European Union).

Date/Time

Configures the current date and time of the logger.

Recording interval

Defines the time that passes between the capture of one piece of data and the next. Allows you to choose 1, 5, 15 or 30 minutes.

This parameter affects certain of the unit's characteristics as shown in the table.

Recording interval	Storage capacity	Fast printing	Capacity per memory block
1 min.	80 days	Last 7 memory blocks	96 minutes
5 min.	1 year	Last 7 memory blocks	480 minutes
15 min.	3 years	Last complete calendar week	1 day
30 min.	6 years	Last 7 memory blocks	2 days

Access password

Define a 4-number password to access programming. This password will be requested every time you attempt to access the programming menu. If you enter 4 zeros, the password is disabled.

Blank spaces are equivalent to a zero.

Clear data Log

Deletes all the data saved in the logger to date (clears the memory). To avoid accidental deletions, the unit will request that you enter a numerical code, which can be found in the following table:

1	2	3	4	5	6	7	8	9	10
2421	5832	1294	5119	0547	8168	3632	5901	8533	1942
11	12	13	14	15	16	17	18	19	20
7145	3044	6197	8134	4800	3319	0237	5565	2098	4291



WARNING: This operation deletes all the data recorded by the unit to date. **This data cannot be recovered.** On completion, the date and time will change to 00:00 hours on 01/01/09, and it will therefore be necessary to set them again. All other parameters remain unchanged.

Master/slave mode:

Determines the logger's operating mode if several units are connected in a network (for more information, see chapter 5.1).

Slave address:

Configures the unit's MODBUS address within the network (for more information, see chapter 5).

Ext. Recording address no:

Assigns a slave (MODBUS) address to each of the six external inputs "n" (only active in MASTER mode).

4.2- Language



Defines the language of the logger menus.

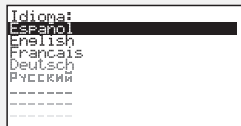

Allows you to change the language of the menus and texts in general displayed on the screen. Select the language and press **SET**.

4.3- Input wizard



Configures the logger inputs.



Select the input to be configured and press **SET**.

This wizard will help you to configure each input. The parameters available will vary depending on the type of input configured.

Use the **▲**, **▼**, **◀** and **▶** keys to change the values and the **SET** key to confirm them and go on to the next parameter. To go back to the previous option, press **ESC**.

Input type:

Select the input type in function of the element connected to it and press **SET** to confirm.

Disabled: There is no element connected to it (on confirming, the wizard will appear).

NTC: There is an NTC probe connected.

Pt100: There is a Pt100 probe connected (only **AKO-15750** and **AKO-15752**)

Pt1000: There is a Pt1000 probe connected.

4-20mA: There is a 4-20mA converter connected.

Digital: There is a voltage-free contact connected.

Display unit:

(Only for NTC, Pt100, Pt1000 and 4-20mA)

Define the display units (°C or °F). If the input type is 4-20mA, you can define the units by means of the built-in text editor (see page 28).

Description:

Allows you to enter a name of up to 10 characters to describe the input (Camera 1, Fruits, Ext. probe, etc.), using the built-in text editor (see page 28).

Enable max. alarm:

(Only for NTC, Pt100, Pt1000 and 4-20mA)

Allows you to enable the maximum value reached alarm. (If you select "Disable", on confirming, the wizard will go to the "Enable min. alarm" parameter).

Maximum alarm:

(Only for NTC, Pt100, Pt1000 and 4-20mA)

Defines the maximum value from which the alarm will be activated.

Maximum alarm delay:

(Only for NTC, Pt100, Pt1000 and 4-20mA)

Configures the delay time from when the maximum value is reached until the alarm is activated.

Enable min. alarm:

(Only for NTC, Pt100, Pt1000 and 4-20mA)

Allows you to enable the minimum value reached alarm. (If you select "Disabled", on confirming, the wizard will appear).

Minimum alarm:

(Only for NTC, Pt100, Pt1000 and 4-20mA)

Defines the minimum value at which the alarm will be activated.

Minimum alarm delay:

(Only for NTC, Pt100, Pt1000 and 4-20mA)

Configures the delay time from when the minimum value is reached until the alarm is activated.

Value at 4mA:

(Only for 4-20mA)

Defines the equivalent value of the 4-20mA converter for a 4mA current (see characteristics of the converter used).

Value at 20mA:

(Only for 4-20mA)

Defines the equivalent value of the 4-20mA converter for a 20mA current (see characteristics of the converter used).

Dig. input polarity:

(Only for digital)



Defines the type of contact connected to the input (normally open or normally closed).

After confirming the last parameter, the wizard ends and goes back to the programming menu.

How the text editor works

In order to facilitate the interpretation of data, you can customise the names of each input with a description of up to 10 characters. If the input type is 4-20mA, you will also be able to edit the display units.

The lower section of the screen shows the changes carried out during the editing process.

- Use the arrow keys ◀, ▶, ▲ and ▼ to scroll through the various available characters and options and the **SET** key to confirm the selection.
- Select  to delete the highlighted text.
- Select ◀ or ▶ to scroll within the text being edited.
- Select  to save your changes and exit the edit menu.

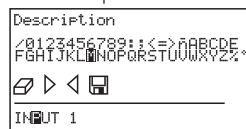

4.4- Contrast



Sets the screen's contrast level.

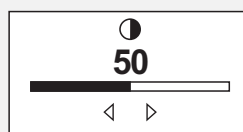

Set the screen's contrast level by pressing keys ◀ and ▶.

4.5- Logged data



Displays the data contained in the memory blocks.

08/05/09	15:30	S=15	N1025
07/05/09	15:30	S=15	N1024
06/05/09	15:30	S=15	N1023
05/05/09	15:30	S=15	N1022
04/05/09	15:30	S=15	N1021
03/05/09	15:30	S=15	N1020
02/05/09	15:30	S=15	N1019
01/05/09	15:30	S=15	N1018

The recordings saved are ordered by blocks. Each block contains the information for a certain recording period. This period varies according to the recording interval configured (see table page 26).

If you make changes to the logger's configuration once the unit is in operation (Type of problem, date, time, input description, etc.) the current memory block closes and new block starts to be recorded, generating a gap in the data continuity, as shown in the example:



Example:

Rec. interval: 15 min
1 block = 1 day

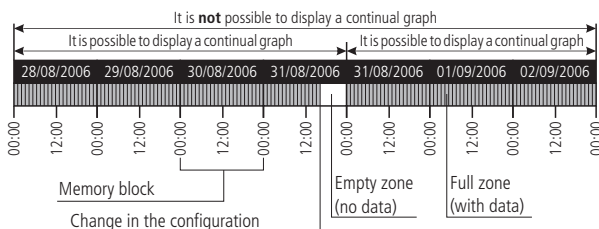

Because it is not possible to represent a graph that contains this type of gap, 2 separate graphs will be displayed. In certain cases (incongruent or faulty data) you will have to access the memory block directly in order to display the data.

To display the data of a block, select it by scrolling and press **SET**. The corresponding graph will be displayed on the screen.

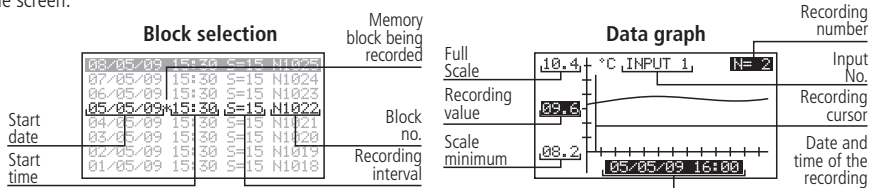

4.6- Inputs



Allows you to edit each input's configurations.

INPUT n
Type
Display Units
Description
Maximum Alarm Enable ↑
Minimum Alarm Enable ↓
Maximum Alarm
Maximum Alarm Delay

With this menu you can access the same configurations mentioned in the input wizard (chapter 4.3), but modifying each parameter separately.

5.- Connectivity

This unit has a port for connecting RS485 (MODBUS) data, enabling it to communicate with other AKO units and even to control them via a PC. There are two possible connection modes.

5.1- Without a PC

The units must be CAMRegis or AKOCAM and it is possible to connect a maximum of 7 units, one in master mode and the rest in slave mode.

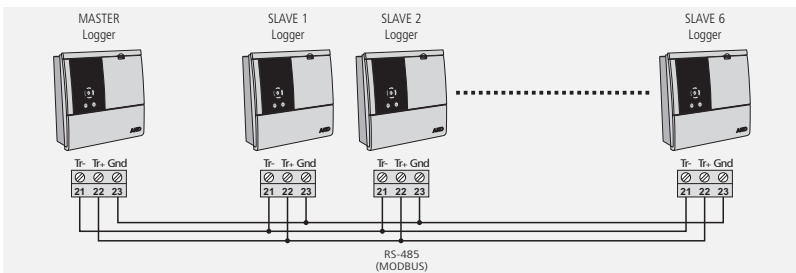

The master can display the data of any of the units connected to it and print them if the unit has a printer (it is recommended to use an AKO-15742 or 15752 as master).

Configuration

Slave equipment: Must be in slave mode (See chapter 4.1) and have a different slave address (MODBUS) configured for each unit. This address must be between 1 and 247.



Master equipment: Must be in master mode. To each of the 6 external inputs will be assigned the address of each of the slaves connected to it (configured in the previous step).

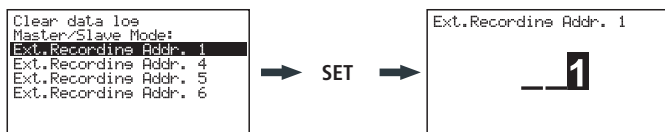

Display external data (only master unit)

On accessing the logger's menu (see chapter 3.3.1) a screen will appear with the list of connected units. The "Local Inputs" option allows you to display the data of the unit's own inputs.

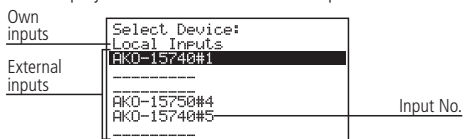

Select a unit, press **SET** and follow the steps described in point 3.3.1 to obtain or print the data recorded for the selected unit.

5.1- With PC or AKO-5005

Any AKO unit that has a comms port can be connected and it is possible to connect up to 127 units to a PC or to the **AKO-5005** web server.

Each of these units must have a different MODBUS address and in the case of CAMRegis loggers must be configured as slaves. **NONE must be in master mode.**

Connection to PC

Allows you to display and capture the data of any connected unit and to configure its parameters using the **AKO-5004** or **SOFTRegis** software.

AKO-5004: For any AKO unit with RS485 (MODBUS) communication. If installed in a server the software can be accessed from any PC connected to it or even from the Internet (requires the server to have an Internet connection and fixed IP).

SOFTRegis: Only for loggers from the CAMRegis range. Not suitable for network operation.

Connection to AKO-5005

Web server that includes the **AKO-5004** software. It can carry out the same functions as the PC, with the advantage that it has a server dedicated to communication with the units.

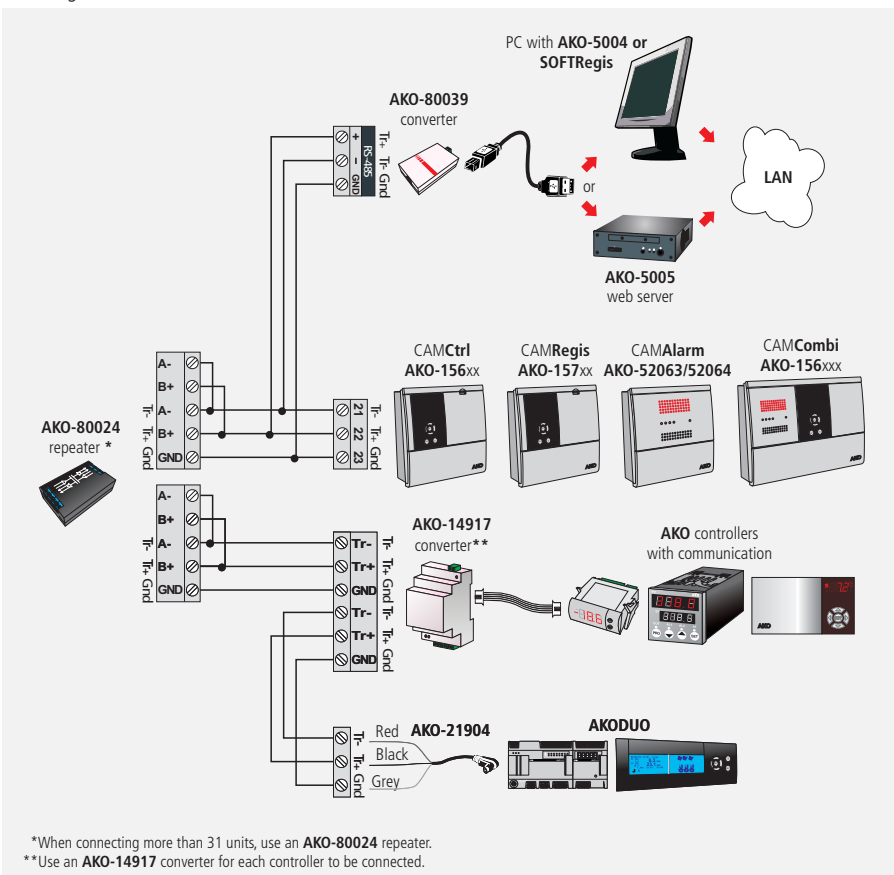

6- Changing the thermal paper roll

AKO-15742/15752 only

When a roll of paper runs out, you must put in a new one Ref. **AKO-15703**.

- With the unit connected to the network, open the front cover and push the release lever (1) back.
- Remove the finished roll and pull gently downwards to extract the remaining paper left in the printer.
- Place the paper roll in the position shown in the figure.
- Insert the end of the paper roll through the bottom slot in the printer until it begins to feed through. As soon as the paper appears in the top slot, the device will stop feeding.
- Return the release lever to its initial position. The printer is now ready to print.
- Press the  key to feed the paper through.

i **IMPORTANT:** The printer paper is thermal and can only be printed on one side. Make sure you insert it properly. The graph paper is thermal and therefore if you wish to keep the graphs for a long time you must make photocopies. The length of an input's graph is less than the length of a sheet of DIN A4.

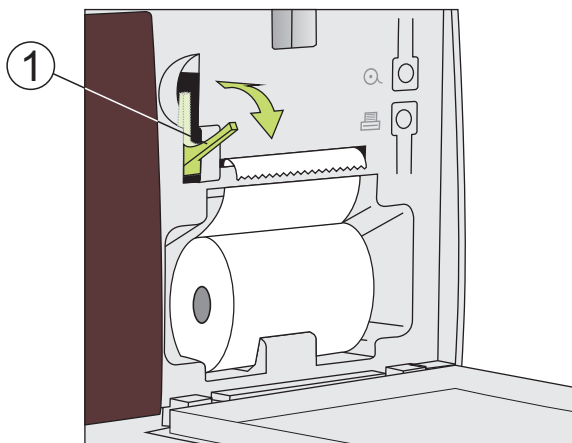

7.- Frequently asked questions

7.1 Date / time

7.1.1.-What happens when I put back the time or date and there is data recorded later than the new date/time? Do I lose this data?

No. But it stops being visible when you enter via the user menu, as the unit detects incongruent dates/hours. However, you can display them by accessing the "Recorded data" section of the programming menu (see chapter 4.5).

7.1.2.-If I put the unit's time forward, do I lose visibility of recordings when accessing via the user menu?

No, you still have it, but you will lose the continuity in the graphs you want to print (time discrepancy). Nevertheless, you can still print the recording of the day/days selected with as many graphs as time discontinuities exist in the recording (hour setting changes).

If you have a recording interval of less than 15 minutes selected, at the moment of printing, a menu will open in which you will be able to select the desired time margin.

When you select the default value only the first continual graph the recording contains will be printed.

7.1.3.-The clock is flashing. What has happened?

There has been an electricity supply failure for a long period and the internal battery has run down.

After this anomaly, the system will boot with the date/hour of the last recording stored and therefore no data will be lost. When you programme the hour again it stops flashing.

Since a change to the hour setting will always put the clock forward, no visibility of any previous recording will be lost.

7.1.4.-Do I have to configure the logger every time there is a Summer to Winter hour change or viceversa?

If the "Winter/Summer Schedule" option (See chapter 4.1) is in automatic mode, you don't have to do anything. The time will update automatically.

If this option is configured in manual mode, the easiest option is to go to the "Winter/Summer Schedule" menu and select the corresponding seasonal time setting (See chapter 4.1)

7.1.5.-If I have the automatic time change enabled what will happen when the time is put forward or back?

The same will happen as when the time is put back or forward manually (See questions 1 and 2)

7.1.6.-What happens if I make a mistake entering the date/time and the unit has already recorded data?

There are two possibilities:

- If the data recorded up to that moment is NOT valid, the log history can be cleared via the programming menu (See chapter 4.1).
- If the data recorded up to that time IS valid, you simply have to correct the date/time and therefore this data will remain stored in the previous block, visible only by going back through the recordings while you display a graph on the screen (See chapter 3.3.1).

7.1.7.-The unit has undergone a number of date/time changes in a few days and I cannot access the data recorded during this period.

In certain cases like this one, the unit may have problems locating the recordings by searching by date due to hour or date incongruity. You can locate the recordings by directly accessing the memory blocks via the programming menu (See chapter 4.5).

7.2 Printing

7.2.1.-When I press the print key (Fast printing function), the following message appears on the screen: "Insufficient data to print the complete graph".

This indicates that the unit does not have sufficient data stored to create a complete graph and can occur in any of the following cases:

- You have only recently installed the logger and do not yet have sufficient data recorded, i.e. the minimum time for creating a complete graph has not yet been reached.
- You have made some change to the configuration (recording interval, date/time, input description, units, type of probe, etc.). When this happens, the unit will close the current memory block and start a new one and therefore you must wait again until the minimum time for creating a complete graph has passed.
- If the seasonal time setting has been changed from winter to summer (This does not happen on changing the time setting from Summer to Winter), i.e. the has been put back and therefore the same happens as in the previous case.

In these cases, the unit will print the last complete graph available in the memory, i.e. the last 7 complete memory blocks. If it cannot find them, it will print the last data recorded (incomplete graph).

The minimum time for creating a complete graph depends on the recording interval as shown in the table:

Recording interval	Minimum time for complete graph
1 min.	11 hours
5 min.	56 hours
15 min.	1 week
30 min.	14 days

7.2.2.-When I print the graphs, in some inputs the "Probe Error" message appears and that input's graph doesn't print.

Either the probe connected to that input is faulty or there is no probe connected to that input. In the first case, you just have to replace it, in the second case, we recommend you disable the input as described in chapter 4.3.

7.2.3.-When I print the data for a specific day, the graph also shows the data of the day after.

This is completely normal as the unit always prints memory blocks up to the end and these can contain data from the day after the one selected.

7.2.4.-When I print all the inputs' graphs, there is a difference in time between the first and last input.

If the recording interval is 1 minute, this is normal, as the printer can take over a minute to print them all and the last graphs will show a few more recordings than the first.

7.2.5.-When I print the graphs of all entries, some of them show "0.0" as the minimum registered value and the graphic seems to be interrupted by one or more Xs.

This is how the unit indicates that this input has suffered a probe error.

7.2.6.-Why is it not printing certain input graphs?

- If an input is permanently in error (EEE), that input graph will not be printed. The unit will only indicate the date of the recording requested and will display the message "Probe error".
- If an input is disabled (See chapter 4.3), the graph will not show any data. Only the enabled inputs' data will be printed.

7.2.7.-Transversal stains have started to appear on the printer paper

This indicates that the roll is about to run out. Replace it as soon as possible (see chapter 6).

7.2.8.-I have several loggers connected to each other forming an RS485 network (Modbus). What happens if I do a fast print from the master logger?

The graph of all the unit's enabled inputs will print and subsequently the graphs of all the enabled inputs of each unit connected, differentiating them with an identifying header.

7.2.9.- When printing after changing the roll of paper, it comes out normally but there is nothing printed on it.

Make sure the paper is inserted properly. Since it is thermal paper, only one of the sides is printable (see section 6)

7.3 Data logging**7.3.1.-The unit doesn't display the data recorded on the current day**

If the memory block containing the data of the current day also contains data from the previous day, in order to access this you must enter into the previous day and move forward with the cursor up to the current day (See chapter 3.3).

7.3.2.-I have changed the unit's configuration (recording interval, date/time, input description, units, type of probe, etc.). Can I display the graphs on the screen?

Yes, using the method described in section 3.3.1 of this manual.

7.3.3.-If I stop the data recording do I lose the data stored?

No.

7.4 Operation**7.4.1.-I have set a timed recording. What happens if the power supply fails and the battery runs down?**

When the power supply returns, the unit will immediately start recording with the recording interval used in the last recording saved.

7.4.2.-What happens if the logger boots with the battery disconnected or run down?

The unit will boot with the date/time of the last recording stored. If there is none, it will boot with the date 01/01/2009 and the configuration wizard will start (see installation manual).

7.4.3.-If recording is stopped can I display the stored data?

Yes, the stored data are visible irrespective of the operating mode.

7.4.4.-The battery symbol is flashing. What does this mean?

The battery is disconnected or not working properly.

7.4.5.-The screen has highly saturated zones and/or vertical stripes. What is this due to?

It could be due to too high a contrast value. You can adjust this via the configuration menu (See chapter 4.4).

7.4.6.- The display shows the stop timed recording icon . How can I override this programming?

Access the recording mode menu, stop it and restart it in REC mode (see section 3.3.3).



AKO ELECTROMECAÁNICA, S.A.L.

Av. Roquetes, 30-38 | 08812 Sant Pere de Ribes | Barcelona | España

Tel. (34) 938 142 700 | Fax (34) 938 934 054 | e-mail: ako@ako.com | www.ako.com

Nos reservamos el derecho de suministrar materiales que pudieran diferir levemente de los descritos en nuestras Hojas Técnicas. Información actualizada en nuestra web.
We reserve the right to supply materials that might vary slightly to those described in our Technical Sheets. Updated information is available on our website.
Nous nous réservons le droit de fournir des produits qui peuvent légèrement différer de ceux décrits dans nos Fiches techniques. Informations actualisées sur notre site Web.
Geringfügige Änderungen der Materialien gegenüber den Beschreibungen in den technischen Datenblättern vorbehalten. Aktualisierte Informationen finden Sie auf unserer Website.
L'azienda si riserva il diritto di fornire materiali che potrebbero essere leggermente diversi da quelli descritti nelle Schede tecniche. Informazioni aggiornate nel nostro sito web