

Digital controller with off cycle defrost
XR20C – XR20D

CONTENTS

- 1. GENERAL WARNING _____ 1
- 2. GENERAL DESCRIPTION _____ 1
- 3. CONTROLLING LOADS _____ 1
- 4. FRONT PANEL COMMANDS _____ 1
- 5. TEMPERATURE ALARM AND ITS DURATION RECORDING (HACCP) _____ 1
- 6. MAIN FUNCTIONS _____ 2
- 7. PARAMETERS _____ 2
- 8. DIGITAL INPUT (IF AVAILABLE) _____ 2
- 9. INSTALLATION AND MOUNTING _____ 3
- 10. ELECTRICAL CONNECTIONS _____ 3
- 11. HOW TO USE THE HOT KEY _____ 3
- 12. ALARM SIGNALS _____ 3
- 13. TECHNICAL DATA _____ 3
- 14. CONNECTIONS _____ 3
- 15. DEFAULT SETTING VALUES _____ 4

1. GENERAL WARNING

1.1 PLEASE READ BEFORE USING THIS MANUAL

- This manual is part of the product and should be kept near the instrument for easy and quick reference.
- The instrument shall not be used for purposes different from those described hereunder. It cannot be used as a safety device.
- Check the application limits before proceeding.

1.2 SAFETY PRECAUTIONS

- Check the supply voltage is correct before connecting the instrument.
- Do not expose to water or moisture: use the controller only within the operating limits avoiding sudden temperature changes with high atmospheric humidity to prevent formation of condensation
- Warning: disconnect all electrical connections before any kind of maintenance.
- Fit the probe where it is not accessible by the End User. The instrument must not be opened.
- In case of failure or faulty operation send the instrument back to the distributor or to "Dixell S.p.A." (see address) with a detailed description of the fault.
- Consider the maximum current which can be applied to each relay (see Technical Data).
- Ensure that the wires for probes, loads and the power supply are separated and far enough from each other, without crossing or intertwining.
- In case of applications in industrial environments, the use of mains filters (our mod. FT1) in parallel with inductive loads could be useful.

2. GENERAL DESCRIPTION

Models **XR20C**, format 32 x 74 mm, and **XR20D**, DIN rail format, are thermostats with off cycle defrost designed for refrigeration applications at normal temperature. They have a relay output to drive the compressor and a PTC or NTC probe input. A internal timer manages the off cycle defrost. The instrument is fully configurable through special parameters that can be easily programmed through the keyboard.

3. CONTROLLING LOADS

3.1 COMPRESSOR

The regulation is performed according to the temperature measured by the thermostat probe with a positive differential from the set point: if the temperature increases and reaches set point plus differential the compressor is started and then turned off when the temperature reaches the set point value again.

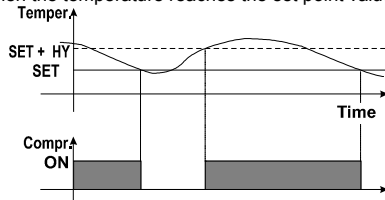

In case of fault in the thermostat probe the start and stop of the compressor are timed through parameters "CO_n" and "CO_F".

3.2 DEFROST

Defrost is performed through a simple stop of the compressor. Parameter "Id_F" controls the interval between defrost cycles, while its length is controlled by parameter "Md_F".

4. FRONT PANEL COMMANDS

XR20C

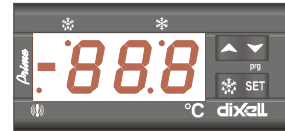

XR20D



SET: To display target set point; in programming mode it selects a parameter or confirm an operation.

☸ (DEF) To start a manual defrost

▲ (UP): To see the last temperature alarm happened; in programming mode it browses the parameter codes or increases the displayed value.

▼ (DOWN) To see the last temperature alarm happened; in programming mode it browses the parameter codes or decreases the displayed value.

KEY COMBINATIONS:

▲ + ▼ To lock & unlock the keyboard.

SET + ▼ To enter in programming mode.

SET + ▲ To return to the room temperature display.

4.1 USE OF LEDS

Each LED function is described in the following table.

LED	MODE	FUNCTION
☸	ON	Compressor enabled
☸	Flashing	-Programming Phase (flashing with ☸) - Anti-short cycle delay enabled
☸	ON	Defrost enabled
☸	Flashing	- Programming Phase (flashing with ☸)
🔊	ON	An temperature alarm happened

5. TEMPERATURE ALARM AND ITS DURATION RECORDING (HACCP)

XR20C signals and records temperature alarms, together with their duration and max value reached. See drawing:

Ex. High temperature alarm

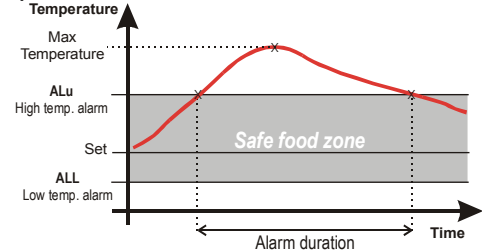

5.1 HOW TO SEE THE ALARM DURATION AND MAX (MIN) TEMPERATURE

If the alarm LED is on, an alarm has taken place.

To see the kind of alarm, the max (min) reached temperature and alarm duration do as follows:

1. Push the Up or Down key.
2. On the display the following message is shown:
"HAL" for high temperature alarm ("LAL" for the minimum alarm), followed by the **Maximum (minimum) temperature**.
Then the "tim" (tiMe) message is displayed, followed by the "Duration" in h.mm.
3. Then the instrument displays the temperature once again.

NOTE1: if an alarm is still occurring the "tim" shows the partial duration.

NOTE2: the alarm is recorded when the temperature come back to normal values

5.2 HOW TO RESET A RECORDED ALARM OR ONE THAT IS STILL OCCURRING



1. Hold the SET key pressed for more than 3s, while the recorded alarm is displayed. (the rSt message will be displayed)
2. To confirm the operation, the "rSt" message starts blinking and the normal temperature will be displayed.

6. MAIN FUNCTIONS

6.1 HOW TO SEE THE SETPOINT

- SET  1. Push and immediately release the **SET** key: the display will show the Set point value;
2. Push and immediately release the **SET** key or wait for 5 seconds to display the probe value again.

6.2 HOW TO CHANGE THE SETPOINT





1. Push the **SET** key for more than 2 seconds to change the Set point value;
2. The value of the set point will be displayed and the  LED starts blinking;
3. To change the Set value push the  or  arrows within 10s.
4. To memorise the new set point value push the **SET** key again or wait 10s.

6.3 HOW TO START A MANUAL DEFROST

-  Push the **DEF** key for more than 2 seconds and a manual defrost will start.

6.4 HOW TO CHANGE A PARAMETER VALUE









To change the parameter's value operate as follows:

-  1. Enter the Programming mode by pressing the Set and DOWN key for 3s ( and  start blinking).
-  2. Select the required parameter.
3. Press the "**SET**" key to display its value (now only the  LED is blinking).
4. Use "**UP**" or "**DOWN**" to change its value.
5. Press "**SET**" to store the new value and move to the following parameter.
- To exit:** Press **SET + UP** or wait 15s without pressing a key.
- NOTE:** the set value is stored even when the procedure is exited by waiting the time-out to expire.

6.5 THE HIDDEN MENU

The hidden menu includes all the parameters of the instrument.

6.5.1 HOW TO ENTER THE HIDDEN MENU



-  1. Enter the Programming mode by pressing the Set +  key for 3s (LED 1 and  start blinking).
-  2. When a parameter is displayed keep pressed the Set +  for more than 7s. The Pr2 label will be displayed immediately followed from the HY parameter.
- NOW YOU ARE IN THE HIDDEN MENU.**
3. Select the required parameter.
4. Press the "**SET**" key to display its value (Now only the  LED is blinking).
5. Use  or  to change its value.
6. Press "**SET**" to store the new value and move to the following parameter.
- To exit:** Press **SET + ** or wait 15s without pressing a key.
- NOTE:** the set value is stored even when the procedure is exited by waiting the time-out to expire.

6.5.2 HOW TO MOVE A PARAMETER FROM THE HIDDEN MENU TO THE FIRST LEVEL AND VICEVERSA.



Each parameter present in the HIDDEN MENU can be removed or put into "THE FIRST LEVEL" (user level) by pressing "**SET + **". In HIDDEN MENU when a parameter is present in First Level the decimal point is on.

6.6 HOW TO LOCK THE KEYBOARD



1. Keep pressed for more than 3 s the  and  keys.
2. The "**POF**" message will be displayed and the keyboard will be locked. At this point it will be possible only to see the set point or the MAX o Min temperature stored
3. If a key is pressed more than 3s the "**POF**" message will be displayed.

6.7 TO UNLOCK THE KEYBOARD

Keep pressed together for more than 3s the  and  keys, till the "**Pon**" message will be displayed.

6.8 THE CONTINUOUS CYCLE

-  When defrost is not in progress, it can be activated by holding the "**▲**" key pressed for about 3 seconds.

The compressor operates in continuous mode for the time set through the "**CCT**" parameter. The cycle can be terminated before the end of the set time using the same activation key "**▲**" for 3 seconds.

7. PARAMETERS

NOTE: the parameters preceded by dots are in the Hidden Menu.

REGULATION

Hy Differential: (0,1 + 25,5°C / 1+255 °F) Intervention differential for set point. Compressor Cut IN is Set Point Plus Differential (Hy). Compressor Cut OUT is when the temperature reaches the set point.

- **LS Minimum set point:** (- 50°C+SET/-58°F+SET): Sets the minimum acceptable value for the set point.
- **US Maximum set point:** (SET+110°C/ SET+230°F). Set the maximum acceptable value for set point.
- **Ot Thermostat probe calibration:** (-12,0+12,0°C; -120+120°F) allows to adjust possible offset of the thermostat probe.
- **OdS Outputs activation delay at start up:** (0+255min) This function is enabled at the initial start up of the instrument and inhibits any output activation for the period of time set in the parameter.
- **AC Anti-short cycle delay:** (0+50 min) minimum interval between the compressor stop and the following restart.
- **CcT Compressor ON time during continuous cycle:** (0,0+24,0h; res. 10min) Allows to set the length of the continuous cycle: compressor stays on without interruption for the CCT time. Can be used, for instance, when the room is filled with new products.
- **COOn Compressor ON time with faulty probe:** (0+255 min) time during which the compressor is active in case of faulty thermostat probe. With COOn=0 compressor is always OFF.
- **COF Compressor OFF time with faulty probe:** (0+255 min) time during which the compressor is OFF in case of faulty thermostat probe. With COF=0 compressor is always active.
- **CH Type of action:** CL = cooling; Ht = heating.

DISPLAY

- **CF Temperature measurement unit:** °C=Celsius; °F=Fahrenheit. **WARNING:** When the measurement unit is changed the SET point and the values of the parameters Hy, LS, US, Ot, ALU and ALL have to be checked and modified if necessary.
- **rES Resolution (for °C):** (in = 1°C; dE = 0.1 °C) allows decimal point display.

DEFROST

- **IdF Interval between defrost cycles:** (0+120h) Determines the time interval between the beginning of two defrost cycles.
- **MaDf (Maximum) length for defrost:** (0+255min) When P2P = n, (not evaporator probe: timed defrost) it sets the defrost duration, when P2P = y (defrost end based on temperature) it sets the maximum length for defrost.
- **dFd Temperature displayed during defrost:** (rt = real temperature; it = temperature at defrost start; SET = set point; dEF = "dEF" label)
- **dAd MAX display delay after defrost:** (0+255min). Sets the maximum time between the end of defrost and the restarting of the real room temperature display.

ALARMS

- **ALC Temperature alarms configuration:** (Ab; rE)
 - Ab= absolute temperature: alarm temperature is given by the ALL or ALU values. rE = temperature alarms are referred to the set point. Temperature alarm is enabled when the temperature exceeds the "SET+ALU" or "SET-ALL" values.
- **ALU MAXIMUM temperature alarm:** (SET+110°C; SET+230°F) when this temperature is reached the alarm is enabled, after the "ALD" delay time.
- **ALL Minimum temperature alarm:** (-50,0 ÷ SET°C; -58+230°F when this temperature is reached the alarm is enabled, after the "ALD" delay time.
- **ALd Temperature alarm delay:** (0+255 min) time interval between the detection of an alarm condition and alarm signalling.
- **dAO Exclusion of temperature alarm at startup:** (from 0.0 min to 23,5h) time interval between the detection of the temperature alarm condition after instrument power on and alarm signalling.

DIGITAL INPUT (IF AVAILABLE)

- **i1P Digital input polarity:** oP: the digital input is activated by opening the contact; CL: the digital input is activated by closing the contact.
- **i1F Digital input configuration:**
 - EAL = external alarm: "EA" message is displayed; bAL = serious alarm "CA" message is displayed. PAL = pressure switch alarm, "CA" message is displayed; dor = door switch function; dEF = activation of a defrost cycle; LHT =not enabled; Htr = kind of action inversion (cooling – heating).
- **did:** (0÷255 min)
 - with i1F= EAL or i1F = bAL digital input alarm delay: delay between the detection of the external alarm condition and its signalling.
 - with i1F= dor: door open signalling delay
 - with i1F = PAL: time for pressure switch function: time interval to calculate the number of the pressure switch activation.
- **nPS Pressure switch number:** (0 ÷15) Number of activation of the pressure switch, during the "did" interval, before signalling the alarm event (i2F= PAL). If the nPS activation in the did time is reached, switch off and on the instrument to restart normal regulation.
- **odc Compressor status when open door:** no, Fan = normal; CP, F_C = Compressor OFF

OTHER

- **PbC Type of probe:** it allows to set the kind of probe used by the instrument: PbC = PBC probe, nTC = NTC probe.
- **rEL Software release for internal use.**
- **Ptb Parameter table code:** readable only.

8. DIGITAL INPUT (IF AVAILABLE)

The free contact digital input is programmable in five different configurations by the "i1F" parameter.

8.1 DOOR SWITCH INPUT (i1F = dor)

It signals the door status and the corresponding relay output status through the "odc" parameter:

no, Fan = normal (any change);

CPr, F_C = Compressor OFF;

Since the door is opened, after the delay time set through parameter "did", the door alarm is enabled, the display shows the message "dA" and the regulation restarts. The alarm stops as soon as the external digital input is disabled again. With the door open, the high and low temperature alarms are disabled.

8.2 GENERIC ALARM (i1F = EAL)

As soon as the digital input is activated the unit will wait for "did" time delay before signalling the "EAL" alarm message. The outputs status don't change. The alarm stops just after the digital input is de-activated.

8.3 SERIOUS ALARM MODE (i1F = bAL)

When the digital input is activated, the unit will wait for "did" delay before signalling the "CA" alarm message. The relay outputs are switched OFF. The alarm will stop as soon as the digital input is de-activated.

8.4 PRESSURE SWITCH (i1F = PAL)

If during the interval time set by "did" parameter, the pressure switch has reached the number of activation of the "nPS" parameter, the "CA" pressure alarm message will be displayed. The compressor and the regulation are stopped. When the digital input is ON the compressor is always OFF.

If the nPS activation in the did time is reached, switch off and on the instrument to restart normal regulation.

8.5 START DEFROST (i1F = dFr)

It starts a defrost if there are the right conditions. After the defrost is finished, the normal regulation will restart only if the digital input is disabled otherwise the instrument will wait until the "MdF" safety time is expired.

8.6 INVERSION OF THE KIND OF ACTION: HEATING-COOLING (i1F = Htr)

This function allows to invert the regulation of the controller: from cooling to heating and viceversa.

8.7 DIGITAL INPUTS POLARITY

The digital input polarity depends on the "i1P" parameter.

i1P=CL: the input is activated by closing the contact.

i1P=OP: the input is activated by opening the contact

9. INSTALLATION AND MOUNTING

Instrument **XR20C** shall be mounted on vertical panel, in a 29x71 mm hole, and fixed using the special bracket supplied.

To obtain an IP65 protection grade use the front panel rubber gasket (mod. RG-C) as shown in figure.

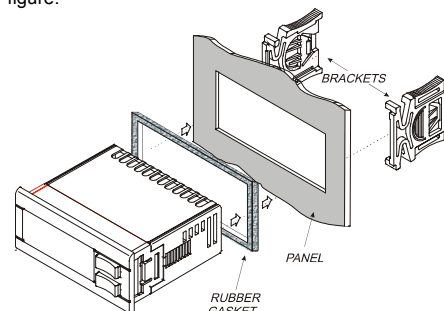
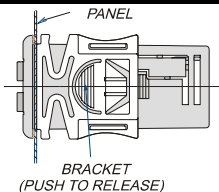

Instrument **XR20D** shall be mounted on an omega DIN rail

The temperature range allowed for correct operation is 0÷60 °C. Avoid places subject to strong vibrations, corrosive gases, excessive dirt or humidity. The same recommendations apply to probes. Let air circulate by the cooling holes.

10. ELECTRICAL CONNECTIONS

The instrument is provided with screw terminal block to connect cables with a cross section up to 2,5 mm². Before connecting cables make sure the power supply complies with the instrument's requirements. Separate the probe cables from the power supply cables, from the outputs and the power connections. Do not exceed the maximum current allowed on each relay, in case of heavier loads use a suitable external relay.

10.1 PROBE CONNECTION

The probes shall be mounted with the bulb upwards to prevent damages due to casual liquid infiltration. It is recommended to place the thermostat probe away from air streams to correctly measure the average room temperature. Place the defrost termination probe among the evaporator fins in the coldest place, where most ice is formed, far from heaters or from the warmest place during defrost, to prevent premature defrost termination.

11. HOW TO USE THE HOT KEY

11.1 HOW TO PROGRAM A HOT KEY FROM THE INSTRUMENT (UPLOAD)

1. Program one controller with the front keypad.
2. When the controller is **ON**, insert the "Hot key" and push **▲** key; the "uPL" message appears followed a by flashing "End"

3. Push "SET" key and the **End** will stop flashing.
4. **Turn OFF** the instrument remove the "Hot Key", then turn it ON again.

NOTE: the "Err" message is displayed for failed programming. In this case push again **▲** key if you want to restart the upload again or remove the "Hot key" to abort the operation.

11.2 HOW TO PROGRAM AN INSTRUMENT USING A HOT KEY (DOWNLOAD)

1. Turn OFF the instrument.
2. Insert a programmed "Hot Key" into the 5 PIN receptacle and then turn the Controller ON.
3. Automatically the parameter list of the "Hot Key" is downloaded into the Controller memory, the "doL" message is blinking followed a by flashing "End".
4. After 10 seconds the instrument will restart working with the new parameters.
5. Remove the "Hot Key".

NOTE the message "Err" is displayed for failed programming. In this case turn the unit off and then on if you want to restart the download again or remove the "Hot key" to abort the operation.

12. ALARM SIGNALS

Message	Cause	Outputs
"P1"	Room probe failure	Compressor output according to par. "Con" and "COF"
"HA"	Maximum temperature alarm	Outputs unchanged.
"LA"	Minimum temperature alarm	Outputs unchanged.
"dA"	Door open	Regulation restarts
"EA"	External alarm	Output unchanged.
"CA"	Serious external alarm (i1F=bAL)	All outputs OFF.
"CA"	Pressure switch alarm (i1F=PAL)	All outputs OFF

12.1 ALARM RECOVERY

Probe alarm "P1" starts some seconds after the fault in the related probe; it automatically stops some seconds after the probe restarts normal operation. Check connections before replacing the probe.

Temperature alarms "HA" and "LA" automatically stop as soon as the thermostat temperature returns to normal values and when defrost starts.

Alarms "EA" and "CA" (with i1F=bAL) recover as soon as the digital input is disabled.

Alarm "CA" (with i1F=PAL) recovers only by **switching off and on** the instrument.

13. TECHNICAL DATA

Housing: self extinguishing ABS.

Case: XR20C frontal 32x74 mm; depth 60mm;

XR20D 4 DIN modules 70x85 mm; depth 61mm

Mounting: XR20C panel mounting in a 71x29mm panel cut-out

XR20D DIN RAIL mounted in a omega (3) din rail

Protection: IP20.

Frontal protection: XR20C IP65 with frontal gasket RG-C (optional).

Connections: Screw terminal block ≤ 2,5 mm² wiring.

Power supply: according to the model: 12Vac/dc, ±10%; 24Vac/dc, ±10%; 230Vac ±10%, 50/60Hz, 110Vac ±10%, 50/60Hz

Power absorption: 3VA max

Display: 3 digits, red LED, 14,2 mm high.

Inputs: 1 NTC or PTC probe.

Digital input: free contact

Relay outputs

compressor: SPDT relay 8(3) A, 250Vac or

SPST relay 20(8)A; 250Vac

Data storing: on the non-volatile memory (EEPROM).

Kind of action: 1B; **Pollution grade:** normal; **Software class:** A.

Operating temperature: 0÷60 °C.

Storage temperature: -30÷85 °C.

Relative humidity: 20÷85% (no condensing)

Measuring and regulation range:

NTC probe: -40÷110°C (-40÷230°F)

PTC probe: -50÷150°C (-58÷302°F)

Resolution: 0,1 °C or 1°C or 1 °F (selectable).

Accuracy (ambient temp. 25°C): ±0,7 °C ±1 digit

14. CONNECTIONS

14.1 XR20C: 8A COMPRESSOR

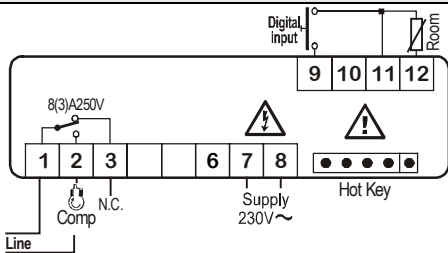

12Vac/dc supply: connect to the terminals 7 and 8.
 24Vac/dc supply: connect to the terminals 7 and 8.
 120Vac supply: connect to the terminals 7 and 8.

14.2 XR20C: 20A COMPRESSOR

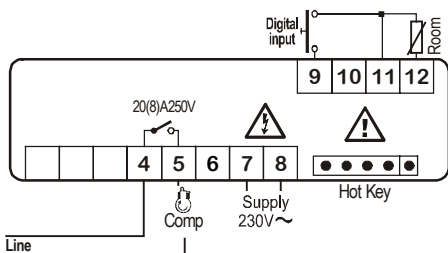

12Vac/dc supply: connect to the terminals 7 and 8.
 24Vac/dc supply: connect to the terminals 7 and 8.
 120Vac supply: connect to the terminals 7 and 8.

14.3 XR20D: 8A COMPRESSOR

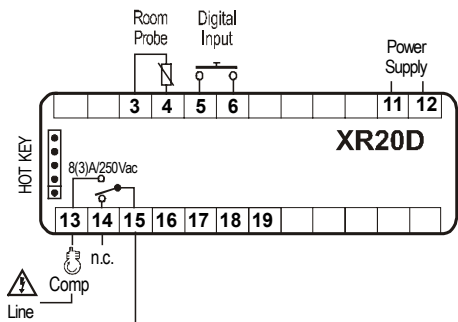

24Vac/dc supply: connect to the terminals 11 and 12.
 120Vac supply: connect to the terminals 11 and 12.
 230Vac supply: connect to the terminals 11 and 12.

14.4 XR20D: 20A COMPRESSOR

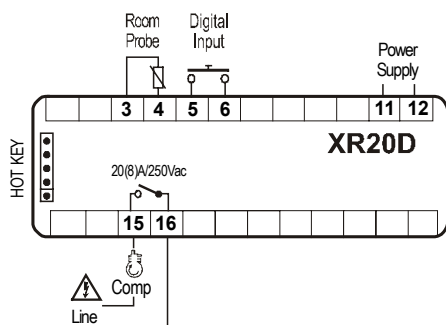

24Vac/dc supply: connect to the terminals 11 and 12.
 120Vac supply: connect to the terminals 11 and 12.
 230Vac supply: connect to the terminals 11 and 12.

15. DEFAULT SETTING VALUES

Label	Name	Range	°C/°F
Set	Set point	LS+US	3.0/37
Hy	Differential	0,1÷25,5°C/ 1÷ 255°F	2.0/4
LS	Minimum set point	-50°C÷SET/-58°F÷SET	-40,0/-40
US	Maximum set point	SET÷110°C/ SET ÷ 230°F	110/230
Ot	Thermostat probe calibration	-12÷12°C /-120÷120°F	0.0
OdS	Outputs delay at start up	0÷255 min	0
AC	Anti-short cycle delay	0 ÷ 50 min	1
CCt	Continuous cycle duration	0.0÷24.0h	0.0
COn	Compressor ON time with faulty probe	0 ÷ 255 min	15
COF	Compressor OFF time with faulty probe	0 ÷ 255 min	30
CH	Kind of action	CL=cooling; Ht= heating	CL
CF	Temperature measurement unit	°C ÷ °F	°C/°F
rES	Resolution	in=integer; dE= dec.point	dE/-
IdF	Interval between defrost cycles	1 ÷ 120 ore	8
MdF	(Maximum) length for defrost	0 ÷ 255 min	20
dFd	Displaying during defrost	rt, it, SEt, DEF	it
dAd	MAX display delay after defrost	0 ÷ 255 min	30
ALc	Temperat. alarms configuration	rE= related to set; Ab = absolute	Ab
ALU	MAXIMUM temperature alarm	Set÷110,0°C; Set÷230°F	110/230
ALL	Minimum temperature alarm	-50,0°C÷Set/ -58°F÷Set	-50/-58
ALd	Temperature alarm delay	0 ÷ 255 min	15
dAO	Delay of temperature alarm at start up	0 ÷ 23h e 50'	1.3
i1P	Digital input polarity	oP=opening;CL=closing	cL
i1F	Digital input configuration	EAL=extern. alarm; bAL=lock regulation; PAL=press. switch; dor=door switch; dEF=defrost; LHt=disabled; Htr= cooling - heating	EAL
did	Digital input alarm delay	0÷255min	5
Nps	Number of activation of pressure switch	0 ÷15	15
odc	Compressor status with open door:	no, Fan = normal; CPR; F_C = Compr. OFF;	no
PbC	Kind of probe	Ptc; ntc	ntc/Ptc
rEL	Software release	--	4.0
Ptb	Map code	--	-

Hidden parameters



Dixell S.p.A. Z.I. Via dell'Industria, 27
 32010 Pieve d'Alpago (BL) ITALY
 tel. +39 - 0437 - 98 33 - fax +39 - 0437 - 98 93 13
 E-mail: dixell@dixell.com - http://www.dixell.com