

AC1-5 INSTRUCTION FOR USE

Thank you for having chosen a LAE electronic product. Before installing the instrument, please read these instructions carefully to ensure maximum performance and safety.

DESCRIPTION

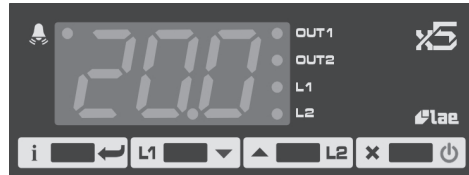

Fig. 1 - Front panel

- Info / Enter button
- Modify Setpoint 1 / Decrease button

INSTALLATION

- Insert the controller through a hole measuring 71x29 mm.
- Make sure that electrical connections comply with the paragraph "wiring diagrams". To reduce the effects of electromagnetic disturbance, keep the sensor and signal cables well separate from the power wires.
- Fix the controller to the panel by means of the suitable clips, by pressingly gently; if fitted, check that the rubber gasket adheres to the panel perfectly, in order to prevent debris and moisture infiltration to the back of the instrument.
- Place the probe T1 inside the room in a point that truly represents the temperature of the stored product.

OPERATION

DISPLAY

During normal operation, the display shows either the temperature measured or one of the following indications:

OFF Controller in stand-by	TUN/xx.x Controller in autotuning
OR Probe T1 overrange or failure	E1 In tuning: timeout1 error
HI Room high temperature alarm	E2 In tuning: timeout2 error
LO Room low temperature alarm	E3 In tuning: overrange error

MENU INFO

The information available in this menu is:

THI Maximum temperature recorded	LOC Keypad state lock
TLO Minimum temperature recorded	

Access to menu and information displayed.

- Press and immediately release button **[I]**.
- With button **[V]** or **[A]** select the data to be displayed.
- Press button **[I]** to display value.
- To exit from the menu, press button **[X]** or wait for 10 seconds.

Reset of THI, TLO recordings

- With button **[V]** or **[A]** select the data to be reset.
- Display the value with button **[I]**.
- While keeping button **[I]** pressed, use button **[X]**.

CHANNEL 1 SETPOINT (display and modification of desired temperature value)

- Press and release button **[L1]**: the LED L1 blinks, the display shows 1SP for 1 second and then the setpoint associated value.
- Press buttons **[V]** or **[A]** to set the desired value (adjustment is within the minimum **SPL** and maximum **SPH** limit).
- To store the new value press button **[I]** or wait for 10 seconds.
- To go back to normal mode without saving the new value, press **[X]**.

CHANNEL 2 SETPOINT

- With the auxiliary output set as thermostat control (**OAU=THR**), it's possible to modify setpoint 2 during the normal operation of the controller.
- Press and release button **[L2]**: the LED L2 blinks, the display shows 2SP for 1 second if setpoint 2 is an absolute threshold (**2SM=ABS**), alternatively the display shows 2DF, if setpoint 2 is a threshold relative to setpoint 1 (**2SM=REL**), then the value associated to the parameter appears.
- Press buttons **[V]** or **[A]** to set the desired value.
- To store the new value press button **[I]** or wait for 10 seconds.
- To go back to normal mode without saving the new value, press **[X]**.

STAND-BY

Button **[X]**, when pressed for 3 seconds, allows the controller to be put on a standby or output control to be resumed (with **SB=YES** only).

KEYPAD LOCK

The keypad lock avoids undesired, potentially dangerous operations, which might be attempted when the controllers is operating in a public place. In the INFO menu, set parameter **LOC=YES** to inhibit all functions of the buttons. To resume normal operation of keypad, adjust setting so that **LOC=NO**.

CONTROLLER AUTOTUNING IN PID MODE

Before starting

In the setup mode (see configuration parameters): set **1CM=PID**; make sure that **1CH** matches the desired operation mode (**1CH=REF** for refrigerating control, **1CH=HEA** for heating control); then adjust setpoint **1SP** at the desired value.

Start autotuning

During normal operation, keep buttons **[I]** + **[V]** pressed for 3 seconds. 1CT blinks on the display. With **[I]** + **[V]** or **[A]** set the cycle time in order to define the dynamic of the process to be controlled. To abort the autotuning function, press **[X]**; to start autotuning press **[V]** + **[A]** or wait for 30 seconds.

During autotuning

During the entire autotuning phase, the display alternates TUN with the actual temperature measured. In case of power failure, when power is resumed, after the initial autotest phase, the controller resumes the autotuning function. To abort the autotuning, without modifying the previous control parameters, keep button **[X]** pressed for 3 seconds. After the autotuning has taken place successfully, the controller updates the control parameters and start to control.

Errors

If the autotuning function failed, the display shows an error code:

- E1 timeout1 error: the controller could not bring the temperature within the proportional band. Increase **1SP** in case of heating control, vice versa, decrease **1SP** in case of refrigerating control and re-start the process.
- E2 timeout2 error: the autotuning has not ended within the maximum time allowed (1000 cycle times). Re-start the autotuning process and set a longer cycle time **1CT**.
- E3 temperature overrange: check that the error was not caused by a probe malfunction, then decrease **1SP** in case of heating control, vice versa increase **1SP** in case of refrigerating control and then re-start the process.
- To eliminate the error indication and return to the normal mode, press button **[X]**.

Control improvement

- To reduce overshoot, reduce the integral action reset **1AR**
- To increase the response speed of the system, reduce the proportional band **1PB**. Caution: doing this makes the system less stable.
- To reduce swings in steady-state temperature, increase the integral action time **1IT**; system stability is thus increased, although its response speed is decreased.
- To increase the speed of response to the variations in temperature, increase the derivative action time **1DT**. Caution: a high value makes the system sensitive to small variations and it may be a source of instability.

RECALIBRATION

- Have a precision reference thermometer or a calibrator to hand. Ensure that **OS1=0** and **SIM=0**.
- Switch the controller off then on again.
- During the auto-test phase, press buttons **[I]** + **[A]** and keep them pressed till the controller shows **0AD**.
- With buttons **[V]** and **[A]** select **0AD** or **SAD**: **0AD** allows a calibration of 0, inserting a constant correction over the whole scale of measurement. **SAD** allows a calibration of the top part of the measurement scale with a proportional correction between the calibration point and 0.
- Press **[I]** to display the value and then use **[I]** + **[A]** or **[V]** to make the read value coincide with the value measured by the reference instrument.
- Exit from calibration by pressing button **[X]**.

CONFIGURATION PARAMETERS

- To get access to the parameter configuration menu, press button **[X]** + **[I]** for 5 seconds.
- With button **[V]** or **[A]** select the parameter to be modified.
- Press button **[I]** to display the value.
- By keeping button **[I]** pressed, use button **[V]** or **[A]** to set the desired value.
- When button **[I]** is released, the newly programmed value is stored and the following parameter is displayed.
- To exit from the setup, press button **[X]** or wait for 30 seconds.

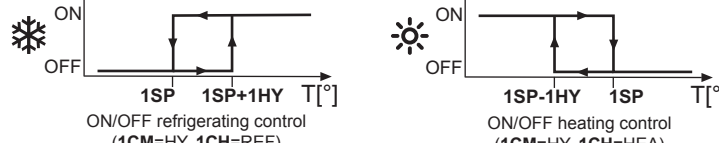
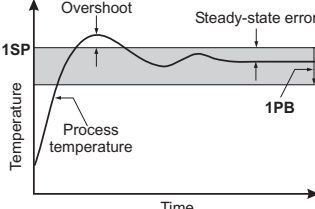
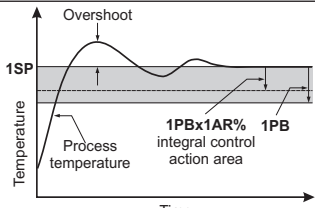
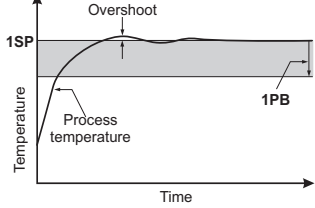
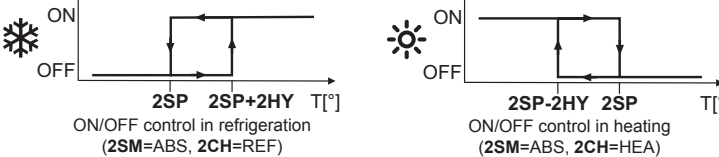
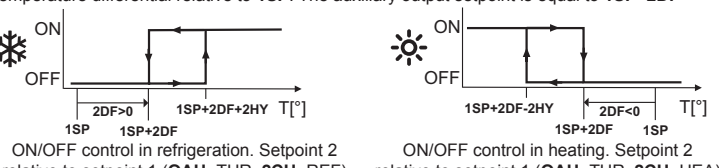
PAR	RANGE	DESCRIPTION	
SCL	1°C; 2°C; °F	Readout scale (see table of input specifications) Caution: upon changing the SCL value, it is then <i>absolutely necessary</i> to reconfigure the parameters relevant to the absolute and relative temperatures (SPL , SPH , 1SP , 1HY etc..)	
SPL	-50°...SPH	Minimum limit for 1SP setting	
SPH	SPL...150°	Maximum limit for 1SP setting.	
1SP	SPL... SPH	Setpoint (value to be maintained in the room).	
1CM	HY; PID	Control mode. With 1CM=HY you select control with hysteresis: parameters 1HY , 1T0 and 1T1 are used. With 1CM=PID you select a Proportional-Integral-Derivative control mode: parameters 1PB , 1IT , 1DT , 1AR , 1CT will be used	
1CH	REF; HEA	Refrigerating (REF) or Heating (HEA) control mode.	
1CM=HY	1HY	0...19.9° OFF/ON thermostat differential. With 1HY=0 the output is always off. 	
	1T0	0...30min Minimum off time. After output 1 has been turned off, it remains inactive for 1T0 minutes regardless of the temperature value measured.	
	1T1	0...30min Minimum on time. (the following parameter will be 1PF). After output 1 has been turned on, it remains active for 1T1 minutes regardless of the temperature value measured.	
1CM=PID	1PB	0...19.9° Proportional bandwidth. Temperature control takes place by changing the ON time of the output: the closer the temperature to the setpoint, the less time of activation. A small proportional band increases the promptness of response of the system to temperature variations, but tends to make it less stable. A purely proportional control stabilises the temperature within the proportional band but does not cancel the deviation from setpoint. With 1PB=0 the output is always off. 	
	1IT	0...999s Integral action time. The steady-state error is cancelled by inserting an integral action. The integral action time, determines the speed with which the steady-state temperature is achieved, but a high speed (1IT low) may be the cause of overshoot and instability in the response. With 1IT=0 the integral control is disabled. 	
	1DT	0...999s Derivative action time. Response overshoot may be reduced by inserting a derivative action. A high derivative action (1DT high) makes the system very sensitive to small temperature variations and causes instability. With 1DT=0 the derivative control is disabled. 	
	1AR	0...100% Reset of integral action time referred to 1PB Decreasing the parameter 1AR reduces the integral control action zone, and consequently the overshoot (see figure on paragraph 1IT).	
	1CT	1...255s Cycle time. It's the period in which the output ON time changes. The quicker the system to be controlled reacts to temperature variations, the smaller the cycle time must be, in order to obtain higher temperature stability and less sensitivity to load variations.	
1PF	ON/OFF	Output state in case of probe failure.	
OAU	NON; THR; AL0; AL1	AUX output operation. NON: output disabled (always off). (the next parameter will be ATM) THR: output programmed for second thermostat control (the next parameter will be 2SM). AL0: contacts open when an alarm condition occurs (the next parameter will be ATM). AL1: contacts make when an alarm condition occurs (the next parameter will be ATM).	
OAU=THR	2SM	ABS; REL	Setpoint 2 mode. Channel 2 setpoint may be absolute (2SM=ABS), or a differential relative to setpoint 1 (2SM=REL).
	2SP	SPL...SPH	Auxiliary output switchover temperature (the next parameter will be 2CH) 
2SM=REL	2DF	-19.9...19.9°	Temperature differential relative to 1SP . The auxiliary output setpoint is equal to 1SP+2DF 

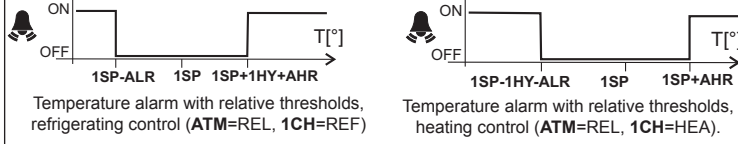
OAU=THR	2CH	REF; HEA	Refrigerating control (REF) or heating control mode (HEA) for the auxiliary output.
	2HY	0...19.9°	Differential of thermostat 2. With 2HY=0 the auxiliary output always remains off.
	2T0	0...30min	Minimum off time. After output 2 has been turned off, it remains inactive for 2T0 minutes regardless of the temperature value measured.
	2T1	0...30min	Minimum on time. After output 2 has been turned on, it remains active for 2T1 minutes regardless of the temperature value measured.
	2PF	ON/OFF	Auxiliary output state in case of probe failure.
ATM	NON; ABS; REL	Alarm threshold management. NON: all temperature alarms are inhibited (the following parameter will be SB). ABS: the values programmed in ALA and AHA represent the real alarm thresholds. REL: the values programmed in ALR and AHR are alarm differentials referred to 1SP and 1SP+1HY . 	
	ALA	-50°...AHA	Low temperature alarm threshold.
ATM=ABS	AHA	ALA...150°	High temperature alarm threshold.
	ALR	-12.0...0°	Low temperature alarm differential. With ALR=0 the low temperature alarm is excluded
ATM=REL	AHR	0...12.0°	High temperature alarm differential. With AHR=0 the high temperature alarm is excluded
	ATD	0...120min	Delay before alarm temperature warning.
SB	NO/YES	Stand-by button enabling.	
INP	0mA/4mA, T1/T2 ST1/SN4	Sensor input selection (see table of input specifications). <i>In the models AC1-5A..., AC1-5J..., AC1-5T... only.</i>	
RLO	-19.9...RHI	Minimum range value (in the models AC1-5A..., AC1-5I... only) RLO takes the minimum value measured by the transmitter (i.e. the value matching 0V, 0/4mA).	
RHI	RLO...99.9	Maximum range value (in the models AC1-5A..., AC1-5I... only) RHI takes the maximum value measured by the transmitter (i.e. the value matching 1V, 20mA)	
OS1	-12.5...12.5°	Probe T1 offset.	
TLD	1...30min	Delay for minimum temperature (TLO) and maximum temperature (THI) logging.	
SIM	0...100	Display slowdown	
ADR	1...255	AC1-5 address for PC communication	

INPUT SPECIFICATIONS

MODEL	INPUT	RANGE [MEASUREMENT ACCURACY]		
		SCL=1°C	SCL=2°C	SCL=°F
AC1-5A...	0+1V	RLO+RHI [< ± 3mV]		---
AC1-5I...	INP = 0mA	RLO+RHI [< ± 0.2mA]		---
	INP = 4mA	RLO+RHI [< ± 0.2mA]		---
AC1-5J...	INP=T1	---	-50+750°C [< ±3°C]	-60+999°F [< ±5°F]
	INP=T2	---	-50+999°C [< ±3°C]	
AC1-5P...	PT100	-50/-19.9+99.9/150°C [< ±0.3°C]	-100+850°C [< ±1°C(-50+850°), ±2°C]	-150+999°F [< ±2°F(-60+999°), ±4°F]
		INP=ST1	PTC 1000 Ω (LAE ST1...) [-50/-19.9 + 99.9/150°C [< ±0.3°C(-30+130°), ±1°C]	-50 + 150°C [< ±0.3°C(-30+130°), ±1°C]
AC1-5T...	INP=SN4	NTC 10K Ω (LAE SN4...) [-40/-19.9 + 99.9/125°C [< ±0.3°C(-40+100°), ±1°C]	-40 + 125°C [< ±0.3°C(-40+100°), ±1°C]	-40 + 260°F [< ±0.6°F(-40+210°), ±2°F]

WIRING DIAGRAMS

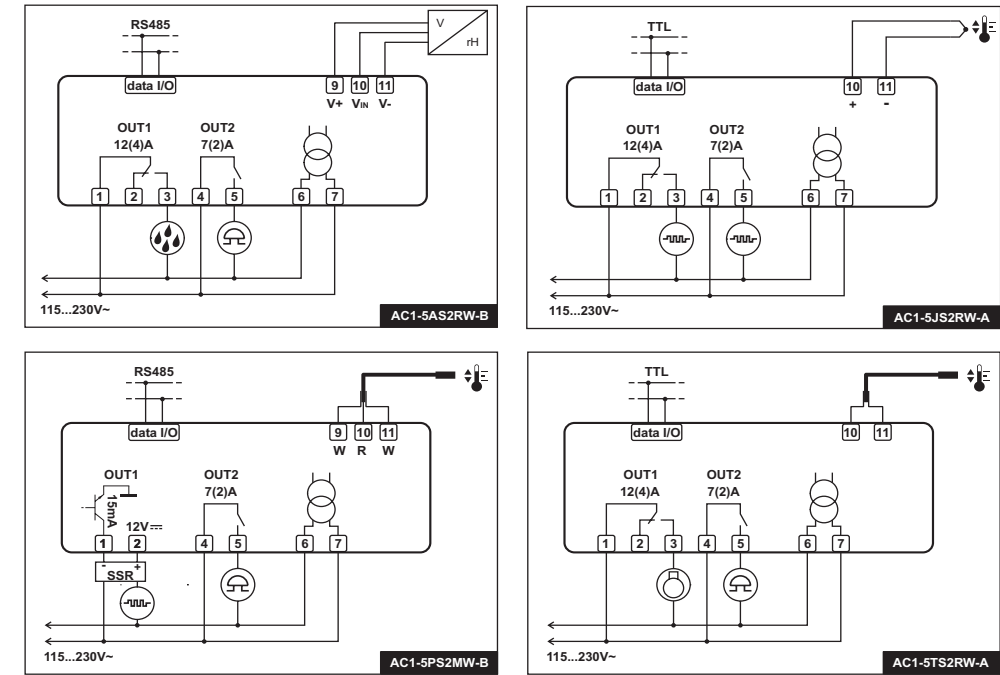

TECHNICAL DATA

Power supply
AC1-5...D 12Vac/dc ±10%, 2W
AC1-5...W 110 - 230Vac±10%, 50/60Hz, 2W

Relay outputs (AC1-5..R.)

OUT1 12(4)A
OUT2 7(2)A

SSR drive (AC1-5..M.)

OUT1 15mA 12Vdc

Inputs

see table of input specifications

Measurement range

see table of input specifications

Measurement accuracy

see table of input specifications

Operating conditions

-10 ... +50°C; 15%...80% U.R.

CE (Reference Norms)

EN60730-1; EN60730-2-9;
EN55022 (Class B); EN50082-1

Front protection

IP55

lae
ELECTRONIC

VIA PADOVA, 25
31046 ODERZO /TV /ITALY
TEL. +39 - 0422 815320
FAX +39 - 0422 814073
www.lae-electronic.com
E-mail: sales@lae-electronic.com

