



XB590L BLAST CHILLER

INDEX

1. GENERAL WARNING	4
1.1 PLEASE READ BEFORE USING THIS MANUAL	4
1.2 SAFETY PRECAUTIONS	4
2. GENERAL FEATURES	4
3. MOUNTING & INSTALLATION	5
3.1 CUT OUT FOR FRONT OR BACK-PANEL MOUNTING	5
4. CONNECTIONS	5
5. FRONT PANEL	6
5.1 POLYCARBONATE VERSION (BACK PANEL MOUNTING - STANDARD DIXELL)	6
5.2 INOX VERSION (FRONT PANEL MOUNTING – STANDARD DIXELL)	6
6. QUICK REFERENCE GUIDE	6
6.1 DISPLAY	6
6.2 KEYBOARD	6
6.3 INSTRUMENT IN OFF AND STAND-BY	7
6.4 STARTING A CYCLE	7
6.5 THE KEYBOARD AND DISPLAY DURING OPERATION OF A CYCLE	8
6.6 OTHER FUNCTIONS (DEPENDING ON THE CONFIGURATION OF THE KEYS)	9
6.7 KEY COMBINATIONS	9
6.8 CONFIGURATION OF KEYS	10
6.9 MEANING OF THE LEDS	10
7. CHILLING CYCLES (1, 2, 3, 4)	11
7.1 HOW TO EDIT THE PARAMETERS OF A CHILLING/FREEZING CYCLE	11
7.2 STRUCTURE OF CHILLING/FREEZING CYCLES (1,2,3,4) - PARAMETERS	12
7.3 INSERT PROBE MANAGEMENT	13
7.4 CHILLING CYCLE EXAMPLE	14
7.4.1 First phase: "Hard chill"	14
7.4.2 Second phase: "Soft chill"	14
7.4.3 Third phase: "Freezing cycle"	14
7.4.4 End of the freezing cycle and start of the hold phase (selectable)	15
8. DEFROST	15
8.1 DEFROST REQUEST	15
8.1.1 Expiration of interval between defrosts (only during hold)	15
8.1.2 Pressing of DEF key (only during hold)	15
8.2 TYPE OF DEFROST	15
8.2.1 With electric heater (tdF=rE)	15
8.2.2 With Hot Gas (tdF=in)	16
8.3 END OF DEFROST	16
8.3.1 Timed	16
8.3.2 Because of temperature	16
8.3.3 Request for defrost with evaporator probe temperature greater than the end-of-defrost temperature dtE	16
8.4 DRAIN TIME	16
8.5 TEMPERATURE ALARM DELAY AFTER DEFROST	16
8.6 DISPLAY DURING DEFROST	16
9. CLOCK MANAGEMENT	17
10. CONDENSER TEMPERATURE ALARM MANAGEMENT	17
11. ALARM SIGNALS	17
11.1 KIND OF ALARMS	17
11.2 HACCP ALARMS	18
12. COMPRESSOR CRANKCASE HEATING DELAY	19
13. PROGRAMMING PARAMETERS	20
13.1 USER PARAMETERS PR1 LEVEL	20
13.1.1 How to access programming	20
13.2 PARAMETERS WITH PR2 LEVEL PASSWORD	20
14. PARAMETERS	21
14.1 PROBE	21
14.2 DISPLAY AND MEASUREMENT UNIT	21
14.3 DIGITAL INPUTS	21
14.4 AUXILIARY RELAY CONFIGURATION	22
14.5 SECOND RELAY MANAGEMENT	22
14.6 AUXILIARY RELAY MANAGEMENT	22
14.7 DEFROST	22

14.8	FANS	22
14.9	TEMPERATURE ALARMS	23
14.10	CONDENSER TEMPERATURE ALARM	23
14.11	CONFIGURATION OF KEYS	23
14.12	CARTER HEATING	23
14.13	CYCLE ACTIVATED BY 2° DIGITAL INPUT	23
14.14	CYCLE LOG	23
14.15	OTHER	24
15.	PRINTER MANAGEMENT (IF PROVIDED AND CONFIGURED)	24
15.1	XB07PR – KIT (OPTIONAL)	24
15.2	XB07PR - DIMENSIONS	24
15.3	XB07PR – MOUNTING	25
15.4	CONNECTION TO THE XB590L – XB07PR	25
15.5	PRINTER SETTING	26
16.	ELECTRICAL CONNECTIONS	26
16.1	PROBES CONNECTION	26
17.	SERIAL LINE	27
18.	USE OF THE PROGRAMMING “HOT KEY “	27
18.1	DOWNLOAD (FROM THE “HOT KEY” TO THE INSTRUMENT)	27
18.2	DOWNLOAD PROCEDURE OF PARAMETERS FROM THE INSTRUMENT TO THE USB KEY	27
19.	TECHNICAL DATA	28
20.	STANDARD VALUES OF THE PARAMETERS.	29
20.1	Chilling cycles	31

1. GENERAL WARNING

1.1 PLEASE READ BEFORE USING THIS MANUAL

- This manual is part of the product and should be kept near the instrument for easy and quick reference.
- The instrument shall not be used for purposes different from those described hereunder. It cannot be used as a safety device.
- Check the application limits before proceeding.
- Dixell Srl reserves the right to change the composition of its products, even without notice, ensuring the same and unchanged functionality.

1.2 SAFETY PRECAUTIONS

- Check the supply voltage is correct before connecting the instrument.
- Do not expose to water or moisture: use the controller only within the operating limits avoiding sudden temperature changes with high atmospheric humidity to prevent formation of condensation
- Warning: disconnect all electrical connections before any kind of maintenance.
- Fit the probe where it is not accessible by the End User. The instrument must not be opened.
- In case of failure or faulty operation send the instrument back to the distributor or to "Dixell S.r.l." (see address) with a detailed description of the fault.
- Consider the maximum current which can be applied to each relay (see Technical Data).
- Ensure that the wires for probes, loads and the power supply are separated and far enough from each other, without crossing or intertwining.
- In case of applications in industrial environments, the use of mains filters (our mod. FT1) in parallel with inductive loads could be useful.

2. GENERAL FEATURES

The series XB has been created for fast chilling or freezing goods according to international food safety standards. Lo strumento dispone delle seguenti funzioni:

- there are FOUR types of cycles:
 - * Soft Chilling
 - * Hard Chilling
 - * Soft Freezing
 - * Hard Freezing

At the end of each cycle the instrument switches automatically to Hold mode.

The user can select one of them according to his own requirements and modify it as he wants..

- Any cycle can be manually terminated before the normal.
- Each cycle can use up to 3 insert probes or a MultiPoint probe (max 3 points) to be inserted in the product.
- During the Cycle there are no defrosts and the fans are always on, a defrost cycle can be done before any freezing cycle.
- Each cycle can be divided into 3 phases + hold with dedicated parameters.
- Low and high temperature alarm management of the condenser.
- Log of last 15 HACCP alarm incidents (high temperature, power failure and maximum cycle time exceeded).
- Option to activate a delay on instrument startup to enable heating of the compressor carter.
- Each instrument is provided with an output for remote display
- The XB590L controller is provided with internal real time clock and can be connected to the XB07PR printer.
- Reading and writing parameters can be managed, in addition from the instrument keyboard, through the Dixell Wizmate software.

3. MOUNTING & INSTALLATION

The **XB590L** can be fitted to the back panel, with a 150x31mm hole, and fixed with 2 studs 165mm apart. To increase protection, use the rear-front protective rubber mod. PG-L (optional). To apply the polycarbonate in the front panel, drill a hole in the panel as shown in chapter 3.1.

The ambient operating temperature range is from 0÷60°C (RH 20÷85%). Avoid locations subject to heavy vibration, corrosive gases or excessive dirt. The same warnings have to be applied to the probes. Ensure enough ventilation around the instrument.

3.1 CUT OUT FOR FRONT OR BACK-PANEL MOUNTING

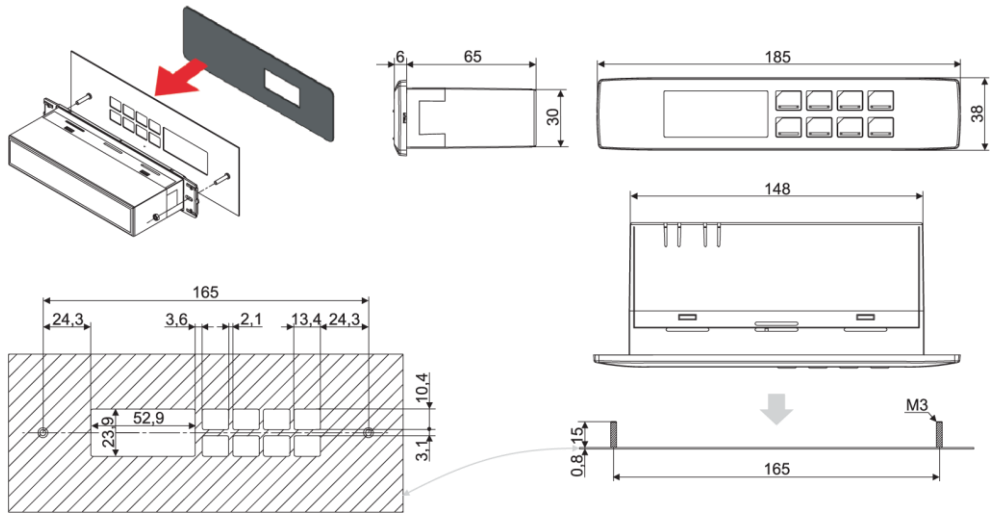

4. CONNECTIONS

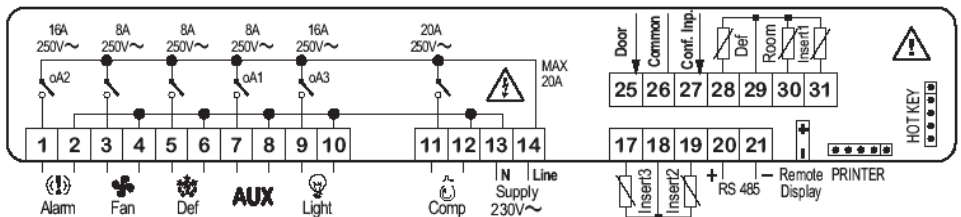

Insert probes 2 and 3 (17-18-19) are disabled at the factory.

Relay outputs 9-10 (oA3)=light, 7-8 (oA1)=Aux, 1-2(oA2)=alarm are configured at the factory.

Port micro connects to contacts 25-26.

5. FRONT PANEL

5.1 POLYCARBONATE VERSION (BACK PANEL MOUNTING - STANDARD DIXELL)



5.2 INOX VERSION (FRONT PANEL MOUNTING – STANDARD DIXELL)



6. QUICK REFERENCE GUIDE

6.1 DISPLAY

- Upper Display: Cell temperature
- Lower Display: Timer or insert probe
- Alarm and status icons.

If an icon or LED is on, the correspondent function is enabled.

If an icon or LED is flashing, the correspondent function is delayed.



6.2 KEYBOARD

The keyboard consists of 8 keys configured as follows:

- On/Off
- **CHILL** Chilling cycle
- **FREEZE** Freezing cycle
- **HARD** Hard Cycles (Chilling and freezing)
- **SET** Setting holding set
- Menu key, up and defrosting
- Down key, temperature/time
- **AUX** Auxiliary exit key



6.3 INSTRUMENT IN OFF AND STAND-BY

Off:

To switch on the instrument from the OFF status, shown by the OFF label on the display.

press the button 

The instrument will be placed in stand-by while waiting for a cycle to be selected and displaying the temperature of the control probe.

Display in the OFF status:







Display in the Stand-by status:





6.4 STARTING A CYCLE

Stand-by:

On switching the instrument on, the icons   in the display will flash to indicate that the Soft Chilling (1) or Soft Freezing (2) cycles can be selected; by pressing the key **HARD** the LEDs   will flash to indicate that the Hard Chilling (3) or Hard Freezing (4) cycles can be selected.

Soft Chilling selection:

Press and release the button **CHILL**, the icon  turns off and the icon  stays on. To start the cycle press and release the key **CHILL**.

Manual interruption:

Press and release the key **CHILL**. The icon for the current cycle starts to flash. The cycle is restarted by pressing the key **CHILL** again or automatically after the time set by the PAU parameter (maximum time cycle interruption).

Final stop:

Keep the **CHILL** button pressed for more than 2 seconds; the controller will go into stand-by.

Stand-by SOFT Cycles Stand-by HARD Cycles



SOFT Chilling on



Manual interruption (cycle icon which flashes)



Final stop of cycle







Setting the clock(RTC):

Keep the key  pressed to access the clock menu and set the date and time.







Use the arrows  to view the elements:





- Min= minutes
- Hou= hour

<p>Use the arrows  to move between the parameters.</p> <p>- To edit: press SET and set the desired value with the arrows.</p> <p>- To confirm: press SET.</p> <p>- To exit from the menu: press the keys  together or wait 5 sec.</p>		<ul style="list-style-type: none"> • dAY= day • Mon= month • YEA= year • tiM=date format <p>Eu=dd/mm/yyyy USA =mm/dd/yyyy</p>
<p>Set the holding temperature at cycle end:</p> <p>If a chilling cycle requires holding then press and release the key SET, and its HdS value (holding setpoint) will be displayed for 5 seconds.</p> <p>To edit HdS: within 5 seconds keep SET pressed until HdS flashes, use the arrows  to edit the value.</p> <p>To confirm: press the key SET again.</p> <p>To disable the holding: To disable the holding simply set the parameter HdS=OFF; this value can be set as 50.1°C)</p>	 	<p>Example of a holding setpoint which will start at the end of the Soft Chilling cycle.</p> <p>After a Chilling or Freezing cycle, the device switches to hold; this phase is recognised because the icon H is on.</p>











6.5 THE KEYBOARD AND DISPLAY DURING OPERATION OF A CYCLE

After starting a chilling cycle, the display will show the following information:



<p>Temperature displaying: Upper display: thermostat probe. Lower display: insert probe (if enabled) or the countdown of the maximum time.</p> <p>Displaying change: by pressing the button  the probes iP2, iP3 (if present) are displayed in sequence and followed by the maximum duration to the end of the cycle.</p>	<p>Thermostat probe temperature</p>  <p>Insert probe temperature</p>	<p>Thermostat probe temperature</p>  <p>Remaining time</p>
<p>Displaying cycle phase: By pressing  once, the phase of the current cycle is displayed for 5 seconds. If a phase is not enabled this will not be displayed.</p>		<p>Depending on the cycle configuration, the display will show: PH1= phase 1 PH2= phase 2 PH3= phase 3</p>

<p>Checking the control set:</p> <p>By pressing the key SET in sequence:</p> <ol style="list-style-type: none"> 1) rSI = thermostat set 2) iSI = phase end set for the probe 3) return to normal display 		
<p>Changing the control sets:</p> <p>When rSI or iSI are displayed, hold the key SET pressed until the label on the display flashes.</p> <p>At this point, use the arrow keys  and then press the key SET to confirm.</p>		

6.6 OTHER FUNCTIONS (DEPENDING ON THE CONFIGURATION OF THE KEYS)

<p>AUX: by pressing and releasing the AUX key you activate/deactivate the auxiliary relay (if configured)</p> <p>LIGHT: Pressing and releasing it activates or deactivates the light relay.</p> <p>PRINTER: by pressing the key, if it is connected to a printer, printing starts at intervals as per the configuration.</p>		
<p>PRINTER CONFIGURATION</p> <p>Press the key  for a few seconds to access the printer menu. The first label itP is displayed.</p> <p>To scroll: </p> <p>To edit: press SET and then the keys </p> <p>To confirm: press SET.</p> <p>To exit from the menu: press SET +  together or wait 5 seconds.</p>		<p>PRINTER CONFIGURATION</p> <p>Press the key  for a few seconds to access the printer menu. The first label itP is displayed.</p> <p>To scroll: </p> <p>To edit: press SET and then the keys </p> <p>To confirm: press SET.</p> <p>To exit from the menu: press SET +  together or wait 5 seconds.</p>

6.7 KEY COMBINATIONS

	<p>The keyboard unlock or lock combination; the lock does not allow editing the parameters while the instrument functions are still active.</p>
	<p>Access to parameter programming from stand-by. From level "Pr2" you can show or hide a parameter in level "Pr1"; from level Pr2 it is clear whether the parameter is visible in Pr1 if the point of the lower display is on 88.88</p>

	<p>From programming, you go back to the upper menu</p>
--	--

6.8 CONFIGURATION OF KEYS

The instrument, compared to the standard Dixell configuration, can be configured with different functions for the keys; other possible configurations are:

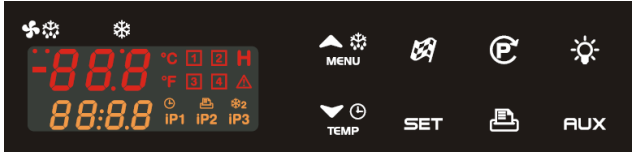

This type of configuration requires:

- Key **CHILL** (parameter b2) configured as SSt
- Key **FREEZE** (parameter b3) configured as SCy
- Key **AUX** (parameter b4) configured as Lig
- Key **HARD** (parameter b7) configured as Prn
- Key  (parameter b8) configured as AuS.

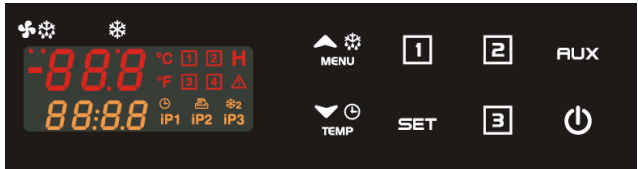





This type of configuration requires:

- Key **CHILL** (parameter b2) configured as Cy1
- Key **FREEZE** (parameter b3) configured as Cy2
- Key **HARD** (parameter b7) configured as Cy3

If the keys are configured with the same function, the controller display will display the label “**Err Conf**”.

6.9 MEANING OF THE LEDS

LED	MODE	ACTION
	ON	Compressor enabled
	Flashing	Programming Phase (flashing with LED  Anti-short cycle delay enabled
	ON	Fan enabled
	Flashing	Programming Phase (flashing with LED  Activation delay active
	ON	Defrost active
	Flashing	Drip time active
<div style="display: flex; gap: 5px;"> 1 2 3 4 </div>	ON	Freezing cycle 1, 2, 3, 4 or hold mode active
	Flashing	Cycle not yet selected or cycle temporarily suspended

LED	MODE	ACTION
	ON	Alarm active
	ON	Hour or time for completion of current cycle
	ON	Printer on (if available and connected)
	Flashing	If, within the HACCP alarm menu, there is an alarm not yet displayed
	ON	Second compressor on (if present and configured)
IP1 IP2 IP3	ON	Displaying insert probe 1, 2 or 3 (if present)
°C °F	ON	Temperature expressed in °C or °F (parameter CF)

7. CHILLING CYCLES (1, 2, 3, 4)

7.1 HOW TO EDIT THE PARAMETERS OF A CHILLING/FREEZING CYCLE

Cycle programming is only possible with the instrument in stand-by (no cycles active).

- Turn the instrument on if the OFF label appears on the display.
 - In the event that the function described in paragraph XX is active, the display will show the label "HoLd" until the counting of the time set in the parameter CCt ends.
- Select the cycle in question (until one of the icons **1** **2** **3** **4** remains on steady).
The icons identify the cycles with the following correspondence:
 - 1** Soft Chilling
 - 2** Soft Freezing
 - 3** Hard Chilling
 - 4** Hard Freezing
- Keep the key **CHILL** pressed for 5 seconds if chilling (Soft or Hard) or the **FREEZE** key if freezing (Soft or Hard) until the display shows the label of the first parameter (**CYS**) of the selected cycle. The lower display shows the first parameter **CYS**, the upper display shows its value.
- Select the desired parameter with the keys .
- Press the **SET** key, the value will start to flash.
- Edit it with the and keys.
As soon as you press a key the value will stop flashing and starts to decrease or increase.
- Press **SET** to store the new value and move to the code of the following parameter.
- Press **SET+** or wait 30sec without pressing any key.

NOTE: the new set value is saved even if the user exits before the time-out.

7.2 STRUCTURE OF CHILLING/FREEZING CYCLES (1,2,3,4) - PARAMETERS

Par	Meaning
cyS	Cycling setting tEP: by temperature; The cycle is done according to the rEM parameter. tiM=timed cycle, based on the Pd1, Pd2, Pd3 parameters.
dbC	Defrost before the cycle Y= defrost is carried out with n=the cycle starts immediately without defrosting.
iS 1	Set point for insertion probe first phase OFF= the phase is timed. Other values= When the temperature measured by the three insert probes reaches this value, the current phase is finished and the next one started.
rS 1	Room probe Set point for the first phase it prevents temperature from reaching a too low value. This value controls the operation of the compressor.
Pd1	If the cycle is timed (first phase) it is considered if the insert probe is not present or in the cases described in the section 7.3 (from 00h:00m to 32h00min, res 10 min); at the end of this time it switches to the next phase. If the cycle is of temperature (first phase) this value is used only if there is an insert probe; this is the maximum duration of the first phase if the temperature defined in parameter is1 is not reached
iS 2	Set point for insertion probe second phase OFF= the phase is timed. Other values = When the temperature measured by the insert probes reaches this value, the current phase is finished and the next one started.
rS 2	Room probe Set point it prevents temperature from reaching a too low value. This value controls the operation of the compressor.
Pd2	If the cycle is timed (second phase) it is considered if the insert probe is not present or in the cases described in the section 7.3 (from 00h:00m to 32h00min, res 10 min); at the end of this time it switches to the next phase. If the cycle is of temperature (second phase) this value is used only if there is an insert probe; this is the maximum duration of the second phase in the event the temperature set in parameter iS2 is not reached.
iS3	Insert Probe Set point: OFF= the phase is timed. Other values = When the temperature measured by the insert probes reaches this value, the current phase is finished and the next one started.
rS3	Chamber set point for the third phase it prevents temperature from reaching a too low value. This value controls the operation of the compressor.
Pd3	If the cycle is timed (third phase) it is considered if the insert probe is not present or in the cases described in the section 7.3 (from 00h:00m to 32h00min, res 10 min); at the end of this time it switches to the next phase. If the cycle is at temperature (third phase) this value is used only if there is an insert probe; this is the maximum duration of the third phase if the temperature defined in parameter iS3 is not reached
dbH	Defrost before the hold phase Yes=defrost is carried out. No= the hold phase starts immediately. If the hold phase is disabled, defrost is not carried out in any case.
HdS	Set point of the holding phase if the value is 50.1°C, the hold phase is disabled.

IMPORTANT NOTE: If the duration time of a phase is set at the OFF value, the corresponding phase is disabled. For example, if Pd3=OFF the third phase of the cycle is not active.

NOTE2 IMPORTANT: If the phases after the one in progress are disabled, the end-of-cycle message is displayed.

7.3 INSERT PROBE MANAGEMENT

By means of the insert probe, it is possible to monitor the internal temperature of the product and, according to it, to set the chilling and freezing cycles.

In fact, the different phases shall be completed when the internal temperature reaches the end-of-cycle values set. If the probe is declared as not present, it is not considered.

If a multipoint insert probe (with 2 or 3 temperature sensors) is used, you must configure the parameters IS1, IS2, iS3 with the value "MP". In this case, the product temperature, during the Chilling, Freezing or Hold phases, will be the average of the temperatures measured by the sensors present in the probe.

As shown in the following table, in order to switch from one phase to another, all the insert probes in use must have reached the end-of-phase temperature, iS1, iS2, and iS3 respectively.

If the current phase is the **last one** enabled, when an insert probe reaches the iSx temperature, where x = 1, 2 or 3, the lower display shows the labels "End i1P" or "End i2P" or "End i3P" alternately. This message remains active until a key is pressed. When a key is pressed, the previous view restarts. During the second phase, when the insert probe reaches the iSx temperature, also the buzzer is activated for the time "bUt" or until a key is pressed.

If during this time another probe reaches iS3 temperature, the relevant identification message is added on the display.

E.g.: if i1P and i3P reached iS3, →i1P→i3P→End is displayed.

7.4 CHILLING CYCLE EXAMPLE

The following drawing explains how a Blast Chiller cycle can be done. To simplify, the use of only one insertion probe is shown.

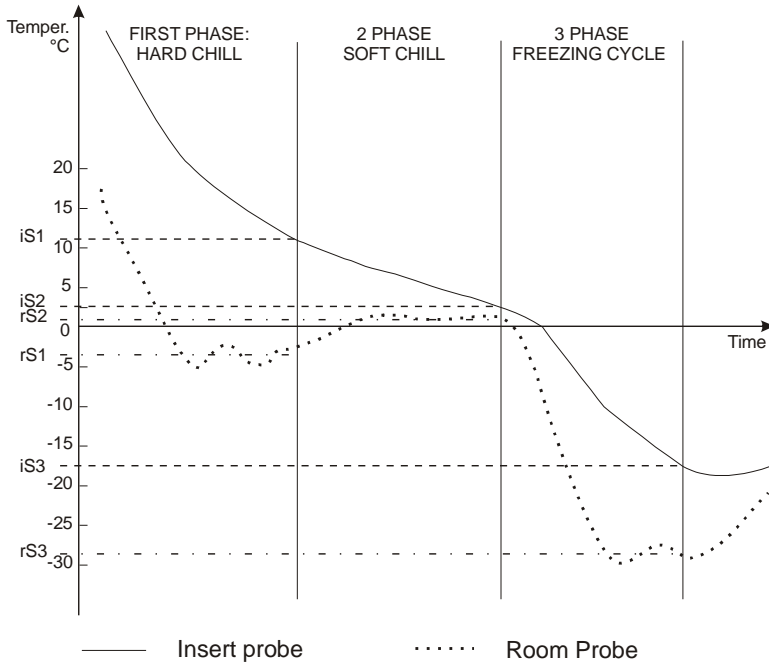

7.4.1 First phase: “Hard chill”

It is usually used to blast chill food just cooked.

It is normally used to fast chill hot foods. E.g. from 80°C / 170°F to 20°C / 70°F

During “Hard Chill”, both compressor and fan are always on until the **rS1** temperature is reached. At this point compressor is turned on end off so as to keep the temperature of the room at the **rS1** value. “Hard Chill” ends when the temperature measured by the 3 insert probes reach the **iS1** value.

7.4.2 Second phase: “Soft chill”

The **Soft Chill** starts when the Hard Chill ends. It is used to prevent thin layer of ice from forming on the product. The Soft Chill lasts until the temperature measured by the 3 insert probes reach the set point **iS2**. During Soft Chill the temperature of the room is regulated by the ambient probe with the set point **rS2**.

7.4.3 Third phase: “Freezing cycle”

Freezing Cycle: used to fast freeze foods.

The Freezing Cycle starts when the Soft Chill ends. During the “Freezing Cycle” both compressor and fan are always on until the **rS3** temperature is reached. At this point compressor and fans are turned on end off so as to keep the temperature of the room at the **rS3** value (normally some degrees below **iS3**). Freezing Cycle ends when the temperature measured by the 3 insert probes reach the **iS3** value.

7.4.4 End of the freezing cycle and start of the hold phase (selectable)

The end of the freezing cycle is indicated by the sound of the buzzer (and possibly also by the activation of the alarm relay if oA1 or oA2 =ALL).

The alarm automatically stops after the “**but**” time or by pressing any keys.

Once the freezing cycle is complete, the instrument automatically starts the hold phase at the temperature set in parameter HdS. If HdS=50.1°C, the hold phase is not carried out and the machine turns off.

NOTE1: with **dbH = yES** a defrost is done before the holding phase.

NOTE2: If the end cycle temperature iS3 is not reached in the maximum time Pd1+Pd2+Pd3 the instrument keep on working, but the alarm message “**OCF**” is given.

8. DEFROST

Interval defrost is enabled only during hold.

In this case, the defrost interval is defined by the parameter idF.

During the defrost cycle, the maximum and minimum temperature alarms are disabled.

If an alarm is already present, these remain also during defrost.

Further possible defrosts are defined by parameters:

- **dbC:** defrost before cycle.
- **dbH:** defrost before hold.

Below is the analysis of the sources of possible requests for defrost cycle start.

8.1 DEFROST REQUEST

Defrost request may occur by:

8.1.1 Expiration of interval between defrosts (only during hold)

A fixed interval between the start of a defrost cycle and the next one is expected and can be set using a parameter (idF). When this interval ends, it is reinitialised and a defrost cycle starts.

8.1.2 Pressing of DEF key (only during hold)

Ensure there are no active cycles or hold is not in progress.

By pressing the **UP/DEF** key for 3 seconds, a request for defrost is sent, regardless of the interval between defrosts (**idF**), which is reinitialised.

NOTE1: during manual defrost, it is possible to both modify the set point of the hold phase and to select a cycle.

NOTE2: if the temperature detected by the evaporator probe is greater than the end-of-defrost temperature (dtE), defrost is not carried out and the message “**nod**” appears on the display-

NOTE 3: to end manual defrosting, keep the corresponding key of the cycle shown in the display pressed for 3 seconds (**CHILL** for 1 and 3, **FREEZE** for 2 and 4).

8.2 TYPE OF DEFROST

The type of defrost, that can be set using a parameter (tdF), can be:

8.2.1 With electric heater (tdF=rE)

by simply turning off the compressor and activating the defrost relay. By simply stopping the compressor, it is possible to run defrost cycles also without defrost relay.

8.2.2 With Hot Gas (tdF=in)

With compressor ON and defrost relay active for the entire duration of defrost. Before activating, the defrost relay and the maximum duration time of the defrost cycle wait for the possible anti-short cycle delay.

8.3 END OF DEFROST

8.3.1 Timed

If the evaporator probe is absent (**EPP=n**), the defrost cycle ends at the expiry of the defrost cycle maximum duration time, which can be set using the parameter (**MdF**).

Defrost ends in time if within **MdF** the temperature of the evaporator probe does not reach the value dtE. In addition, it is terminated in any case if the evaporator probe fails (**P2**).

8.3.2 Because of temperature

If the evaporator probe is present (**EPP=Y**) and detects that the end-of-defrost temperature set using the parameter (**dtE**) is reached, the defrost cycle ends.

If at the end of the defrost cycle maximum duration time (**MdF**) the consent temperature is not reached, defrost ends in any case.

8.3.3 Request for defrost with evaporator probe temperature greater than the end-of-defrost temperature dtE.

If upon the request for defrost the conditions for the end of the defrost cycle ($T2 > dtE$) are met, the defrost cycle does not start at all and the interval between defrosts is reinitialised.

8.4 DRAIN TIME

At the end of the defrost cycle, a Drain time is expected, during which all the adjustment relays are off and the LED  flashes. The duration of the Drain time can be set using the parameter (Fdt).

8.5 TEMPERATURE ALARM DELAY AFTER DEFROST

Only if the exclusion time of the temperature alarm control upon start-up is expired, at the end of the defrost cycle, a delay expressed in minutes is loaded, which can be set using the parameter (**EdA**) for the exclusion of the temperature alarm control. When this time is expired, if a temperature alarm condition is present, the normal temperature alarm delay is loaded (**ALd**).

8.6 DISPLAY DURING DEFROST

For the entire duration of the defrost cycle, by setting with the parameter (**dFd**), it is possible to display the following information:

- current temperature
- detected temperature at the beginning of the defrost cycle
- Set point value
- **dEF** message.

At the end of the defrost cycle, the message **dEF** is replaced by the temperature detected at the beginning of the defrost cycle. At the end of the defrost cycle, the temperature displayed shall be updated as soon as it is lower than the temperature detected at the beginning of the defrost cycle or the Set Point, or when a temperature alarm triggers; otherwise, temperature update shall be carried out at the end of the maximum delay time for temperature update after the defrost cycle set using the parameter (**dAd**).

9. CLOCK MANAGEMENT

Pressing the key  for 5s accesses the menu for the clock, date and hour parameters.

- **Min:** Minutes (from 00 to 59)
- **Hou:** Hours (from 1 to 24)
- **dAy:** day of the month (from 1 to 31)
- **Mon:** month (from 1 to 12)
- **yEA:** years (from 2000 to 2100)
- **tiM:** format **Eu:** European: dd/mm/yyyy; **USA:** American: mm/dd/yyyy

Press the **SET** key, the value will start to flash.

Edit it with the  and  keys.

Press **SET** to store the new value and move to the code of the following parameter.

10. CONDENSER TEMPERATURE ALARM MANAGEMENT







Managing alarms (ATC or btc) is controlled if one of the probes is configured as a Condenser Probe and when a cycle is active and if the probe is not in alarm. The probes can be configured as a condenser probe are those of the evaporator and those of the insert probe.









When an alarm occurs it is signalled on the display ( + "Atc" or "btc") and by the buzzer; the silencing of the relay and the buzzer is managed as an actual tBA parameter (Relay silencing).

The alarm stops when the temperature falls below the temperature with regard to the HyA differential. Depending on the configuration of the parameters bAc and/or bLc the compressor stops.

11. ALARM SIGNALS

11.1 KIND OF ALARMS

Mess.	Cause	Outputs
	Thermostat Probe failure	Alarm output ON. Compressor output according to parameters Con and CoF
	Evaporator Probe failure	Alarm output ON. Fans depend on FnC . Defrost ends in time.
	Insert probe i1PF, i2PF, i3PF failure	Alarm output ON. Other outputs unchanged. The cycle is made by time
	Real Time Clock data lost	Alarm output ON. Other loads not changed. Date and duration of the cycle are not available. Reset clock data.
	Real Time Clock failure	Alarm output ON. Other outputs unchanged. The date and the duration of the cycle are not available.
	Maximum temperature alarm	Alarm output ON. Other outputs unchanged.

Mess.	Cause	Outputs
	Minimum temperature alarm	Alarm output ON. Other outputs unchanged.
	Extended power outage. HACCP	Alarm output ON. The freezing cycle restart from the current phase.
	The maximum cycle time has been exceeded. HACCP	Alarm output ON. Other outputs unchanged. In any case the cycle ends when the final temperature is reached.
	External alarm	Alarm output ON. Other outputs unchanged.
	Serious external alarm	Alarm relay active. All loads OFF. Except for the relays set as timed AUS.
	Door open alarm	Alarm relay active. Fans and compressor OFF.
	Condenser high temperature alarm	Alarm relay active: the operation of the compressor depends on parameter bAc
	Condenser low temperature alarm	Alarm relay active: the operation of the compressor depends on parameter bLc

11.2 HACCP ALARMS

You can view the HACCP alarm events directly in the device's display.
The following alarms are stored:

- HA**, maximum temperature alarm
- PFA**, extended power outage
- OCF**, exceeded maximum cycle time

For each family, the last 15 alarms (with FIFO logic) will be recorded with the following information:

- start of the event (year-month-day, time; minutes)
- duration of the event (time: minutes)

These alarms, if present, can be consulted with the instrument active only if the cycle is not active (stand-by).

To consult the alarm log the procedure is as follows:

- Press and release the key .
- If there are alarms, present the device will display the following information:



Note: if there are no alarms present in a group (either new or previous), the group itself is not present.

- To view the alarms of a group, press the key **SET**.



the display will always show the last alarm event (AL1, AL2, AL3...AL15)

- To view the alarm, press the key **SET**.



- To exit from the event, press the key **SET**.
- With the **MENU** or **TEMP** keys you can select, if present, the other alarms events of the group.
- To exit from an alarm group, keep the **SET** key pressed for 3 seconds.

The alarm events for every single group can be deleted by selecting the group that you want to delete and keeping the **SET** key pressed for 5 seconds; the display will show the label "clrd" to confirm the correct operation.

Exiting the menu can happen automatically after 30 seconds (if no key is pressed) or by pressing the keys **SET+** **MENU** at the same time..

12. COMPRESSOR CRANKCASE HEATING DELAY

Compressor crankcase heating delay (CrankCase Heater) is a function which is managed upon instrument start-up (i.e., when the instrument is powered); the parameters for the management of this function are CCH and CCT.

With the CCH parameter it is possible to define how to activate the delay according to the status of the instrument before it is turned off.

If CCH=0, it means that the delay shall be activated only if the device, before it is turned off, was in OFF condition.

In this case, when the device is powered, the message OFF shall appear on the display, both during and at the end of the same; if the count is still in progress and the user presses the ON/OFF key to turn the device on, the label "HoLd" shall appear on the display. This one remains active until the end of the delay count, then the controller shall be set to stand-by ("stand-by" means as if the ON/OFF key is pressed for the first time when the instrument is OFF). If the ON/OFF key is pressed, the message OFF will appear on the display (and, at the end of the delay, the instrument shall remain in this status).

If CCH=1, it means that the count is considered independently from the status of the device before it is turned off.

If the device was OFF, the logic is the same as described above.

If the device was in STAND-BY, with a CYCLE or HOLD in progress, on the display the message HoLd will be displayed during the entire duration of the delay time; once the delay time has expired, the device will automatically restart from the condition it was in before it is turned off.

Note: also in this case, the user can turn the device OFF and the message on the display will change from HoLd to OFF.

13. PROGRAMMING PARAMETERS

The parameters are displayed by levels:

1. "Pr1"
2. "Pr2".

"Pr1": includes the parameters accessible by the user..

If in the menu there are no parameters, by selecting it, Pr2 is automatically displayed.





Parameter "Pr2" contained in Pr1, includes all instrument parameters (**installer level**).

It is protected by password. Here, it is possible to enable or disable each parameter in "Pr1" (**user level**) by pressing **SET+** .

In "Pr2" if a parameter is enabled at the user level, the yellow point  turns on.



13.1 USER PARAMETERS PR1 LEVEL

13.1.1 How to access programming

1. Hold down **SET+**  keys for 3 seconds until the first parameter is present in Pr1 with the relevant value.
2. With  or , parameters are displayed (lower display) with the relevant value (upper display).
3. By pressing the **SET** key it is possible to modify the parameter
4. Simultaneously press the keys **SET+**  to return to the previous menu.

13.2 PARAMETERS WITH PR2 LEVEL PASSWORD

To access the parameters contained in "Pr2", a password must be entered.

1. Access the Pr1 Menu, select the label "Pr2" and press the key **SET**; the "PAS" flashing message will appear and "0--" will be displayed with the flashing zero.
2. Use  or  to set the correct number on the flashing digit.
3. Confirm this number by pressing **SET**: the digit will stop flashing, thus maintaining the display of the number chosen, and the flashing shall move to the next digit.
4. Repeat operations 2 and 3 for the remaining digits.
5. if the password is correct, by pressing **SET** on the last digit it is possible to access "Pr2", otherwise "Pr2" will be displayed.

If no key is pressed within 15 seconds, the instrument will show the room temperature.

The PASSWORD is 321

NOTE2: each parameter in "Pr2" can be removed or inserted in "Pr1" (user level) by pressing the keys **SET+**



When in "Pr2", if a parameter is present in "Pr1", the yellow point  is on.

14. PARAMETERS

Hy Intervention differential for set point: (0.1 to 12.0 res. 0.1°C or 1°F) always positive. Compressor cut-IN is SET+HY. Compressor cut-OUT is when the temperature reaches the set point.

AC Anti-short cycle delay: (0 to 30 min) minimum interval between the compressor stop and the following restart.

PAU Time of stand by: (0 to 60 min) after this time the controller restart the cycle.

PfT Maximum acceptable duration of power failure: (0 to 250 min) if power failure duration is less than PfT, the cycle restarts from the same point at which it was stopped otherwise the cycle restarts from the beginning of the current phase.

Con Compressor ON time with faulty probe: (0 to 255 min) time during which the compressor is active in case of faulty thermostat probe. With **Con=0** compressor is always OFF.

CoF Compressor OFF time with faulty probe: (0 to 255 min) time during which the compressor is off in case of faulty thermostat probe. With **CoF=0** compressor is always active.

14.1 PROBE

rPO Thermostat probe calibration

EPP Evaporator probe presence: (no; YES)

EPO Evaporator probe calibration

i1P presence insert probe 1: (no; YES,MP) if MP is selected this means that the insert is at 2 or 3 points.

i1o Insert probe 1 calibration

i2P Presence insert probe 2: (no; YES,MP) if MP is selected this means that the insert is at 2 or 3 points

i2o Insert probe 2 calibration

i3P Presence insert probe 3: (no; YES,MP) if MP is selected this means that the insert is at 2 or 3 points

i3o Insert probe 1 calibration

rEM End cycle probe selection: (iPt; rPt) it sets which probe stops the cycle, thermostat probe or insert probe: **iPt** = insert probe; **rPt** = thermostat probe.

EPC Configuration evaporator probe: (EP, CO) defines whether the probe is connected in the position of the Defrost probe for controlling the temperature of the condenser.

i1c Configuration insertion probe 1: (i1, CO) defines whether the probe is connected in the position of the insert probe 1 for controlling the temperature of the condenser.

i2c Configuration insertion probe 2: (i2, CO) defines whether the probe is connected in the position of the insert probe 2 for controlling the temperature of the condenser.

i3c Configuration insertion probe 3: (i3, CO) defines whether the probe is connected in the position of the insert probe 3 for controlling the temperature of the condenser.

14.2 DISPLAY AND MEASUREMENT UNIT

CF Temperature measurement unit: °C=Celsius; °F=Fahrenheit.

rES Resolution (for °C): **in**=integer; **de**=with decimal point

Lod Upper display visualization: select which probe is shown by the upper display: **rP**= Thermostat probe; **EP**= Evaporator probe.

rEd Remote display: select which probe is displayed, **rP**= Thermostat probe; **EP**= Evaporator probe; **i1P**=insert probe 1; **i2P**= insert probe 2; **i3P**= insert probe 3.

14.3 DIGITAL INPUTS

d1P Door switch input polarity (25-26): (OP; CL) select if the digital input is activated by opening or closing the contact. **OP**= opening; **CL**=closing.

Odc Compressor and fan status when open door: **no**=normal; **FAn**=Fan OFF; **CPr**=Compressor(s) OFF; **F_C**=Compressor(s) and fan OFF.

doA Open door alarm delay: (255= not used) delay between the detection of the open door condition and its alarm signalling: the flashing message "dA" is displayed. If **doA=nu** the door alarm will be not signalled.

dLc Stop count down of the running cycle with door open: **Y**=count down is stopped with door opening; **n**=count down goes on with door open.

rrd Regulation restart with door open alarm: **y**=loads turned off by **odC** restart; **n**=no variations.

d2F Second digital input: (EAL; bAL) **EAL**= external alarm; **bAL**= serious alarm, regulation is stopped; **ACy**=the cycle is activated as the parameter dCy.

d2P Configurable digital input polarity (26-27): (OP; CL) select if the digital input is activated by opening or closing the contact. **OP**=opening; **CL**=closing.

did Time delay for digital input alarm: defines the time delay between the detection and the successive signalling of the alarm.

14.4 AUXILIARY RELAY CONFIGURATION

oA1 First auxiliary relay configuration (7-8): ALL=alarm; Lig=light; AuS=second thermostat; tMr=auxiliary relay enabled by keyboard; C2=second compressor.

oA2 Second auxiliary relay configuration (1-2): ALL=alarm; Lig=light; AuS=second thermostat; tMr=auxiliary relay enabled by keyboard; C2=second compressor.

oA3 Third auxiliary relay configuration (9-10): ALL=alarm; Lig=light; AuS=second thermostat; tMr=auxiliary relay enabled by keyboard; C2=second compressor.

14.5 SECOND RELAY MANAGEMENT

2CH Second compressor in holding mode: if $oAi=C2$ than the SET of the second compressor during cycles is $rS1,2,3 + OAS$.

	Chilling	Holding
2CH = C1	C1 On, C2 On	C1 on
2CH = C2	C1 On, C2 On	C2 on
2CH =1C2	C1 On, C2 On	C1 on; C2 On

OAt Second compressor switching on delay: time delay between the switching on of the first and second compressor.

OAS Set point for second compressor: temperature delta of the second compressor added to the set of temperature control ($rs1,2,3$).

OAH Differential for second compressor: ($sempre \neq 0$) differenziale di temperature sul set del secondo compressore.

OAi Second compressor probe: rP=thermostat; EP=evaporator; i1P=insert probe 1; i2P=insert probe 2; i3P=insert probe 3.

14.6 AUXILIARY RELAY MANAGEMENT

OSt AUX output timer: time in which the AUX output stays ON. It is used when **oA1** or **oA2** or **oA3=tMr**.

OSS Set point for AUX output, used when oA1 or oA2 or oA3=AUS.

OSH Differential for AUX output: ($always \neq 0$) intervention differential for the set point of the AUX output, with $OAH < 0$ the action is for heating, with $OAH > 0$ it is for cooling.

OSi Probe selection for the second compressor: rP=thermostat probe; EP=evaporator probe; i1P=insert probe 1; i2P=insert probe 2; i3P=insert probe 3.

14.7 DEFROST

tdF Defrost type: rE= electrical heater; in= hot gas.

ldF Interval between defrost cycles: determines the time interval between the beginnings of two defrost cycles.

dtE Defrost termination temperature: sets the temperature measured by the evaporator probe, which terminates the defrost. Used only if **EPP=YES**.

MdF Maximum length for defrost: when **EPP=no** (timed defrost) it sets the defrost duration, when **EPP=YES** (defrost termination based on temperature) it sets the maximum length for defrost. If **MdF=0** the defrost is disabled.

dFd Temperature displayed during defrost: rt=real temperature; it=temperature at the start of defrost; SEt=set point; dEF="dEF" message.

Fdt Drip time: time intervals between reaching defrost termination temperature and the restoring of the controllers' normal operation.

dAd Defrost display time out: sets the maximum time between the end of defrost and the restarting of the real room temperature display.

14.8 FANS

FnC Fans operating mode during the holding phase:

o-n=continuous mode, OFF during defrost;

C1n=runs in parallel with the first compressor, OFF during defrost;

C2n=runs in parallel with the second compressor, OFF during defrost;

Cn=runs in parallel with compressors, OFF during defrost;

o-Y=continuous mode, on during defrost;

C1y=runs in parallel with the first compressor, on during defrost;

C2y=runs in parallel with the second compressor, on during defrost;

Cy=runs in parallel with compressors, on during defrost;

FSt Fan stop temperature: it used only if the **EPP=YES**. If the temperature, detected by the evaporator probe is above **FSt** fans are stopped.

AFH Differential for the stop temperature and for the alarm: fans carry on working when the temperature reaches the **FSt-AFH** value, the temperature alarm recovers when the temperature is **AFH** degrees below the alarm set.

Fnd Fan delay after defrost: the time intervals between ends of defrost and evaporator fans start.

14.9 TEMPERATURE ALARMS

ALU Maximum temperature alarm: when the **SET+ALU** temperature is reached the alarm is enabled, (possibly after the **ALd** delay time).

ALL Minimum temperature alarm: delay time for confirmation of out-of-range temperature alarm.

ALd Temperature alarm delay: time interval between the detection of an alarm condition and alarm signalling.

EdA Temperature alarm delay at the end of a defrost: time interval between the detection of the temperature alarm condition at the end of defrost and alarm signalling.

tbA Silencing alarm relay: **Y**=silencing buzzer and alarm relay; **n**=only buzzer silencing.

14.10 CONDENSER TEMPERATURE ALARM

Atc Absolute threshold high temperature alarm: when the condenser probe (if configured) reaches this temperature, the high temperature alarm is signalled.

btc Absolute threshold low temperature alarm: when the condenser probe (if configured) reaches this temperature, the low temperature alarm is signalled.

dAc Alarm signalling delay: the **Atc** and **btc** alarms are signalled given the delay of this parameter; if **dAc=0**, this means that the alarm is disabled.

HyA Alarm return differential: differential for return of **Atc** and **btc** alarms.

bAc Machine shutdown if Atc alarm active: if the alarm is active and **bAc=n**, the device continues the control; if **bAc=Y**, the device locks the control.

bLc Machine shutdown if btc alarm active: if the alarm is active and **bLc=n**, the device continues the control; if **bLc=Y**, the device locks the control.

14.11 CONFIGURATION OF KEYS

b2 Configuration CHILL key: this key can take on the configurations **NU**, **SSt**, **Cy1**.

b3 Configuration FREEZE key: this key can take on the configurations **NU**, **SCy**, **Cy2**.

b4 Configuration AUX key: this key can take on the configurations **NU**, **Lig**, **AuS**, **OnF**, **dEF**, **Prn**.

b7 Configuration HARD key: this key can take on the configurations **NU**, **Prn**, **Hrd**, **Cy3**.

b8 Configuration ON/OFF key: this key can take on the configurations **NU**, **AuS**, **OnF**, **Lig**, **dEF**.

14.12 CARTER HEATING

CCH Activation of carter heating delay: this delay can be activated when the instrument is in **OFF** mode (Only **OFF**) or in any state where the instrument is in (**ALL**).

CCT Carter heating delay: the device will be activated at the end of this time; if **CCT=0**, the delay is not considered.

14.13 CYCLE ACTIVATED BY 2° DIGITAL INPUT

dCy Cycle activated by 2° Digital Input: can assume the following configuration **SC**=selected cycle, **Cy1**=start cycle 1, **Cy2**=start cycle 2, **Cy3**=start cycle 3, **Cy4**=start cycle 4.

14.14 CYCLE LOG

The duration of the cycles is memorised only when the cycle ends because of the time or temperature. It is not updated when the cycle is terminated manually.

tCy Duration of the last cycle (read only).

- tP1** Duration of first phase of the last cycle (read only).
- tP2** Duration of second phase of the last cycle (read only).
- tP3** Duration of third phase of the last cycle (read only).

14.15 OTHER

- Adr** Address for RS485: 1 to 247.
- bUt** Buzzer activation at the end of the cycle: (0 to 60 sec; with 0 the buzzer is on till any key will be pushed).
- tPb** Kind of probe: it sets the kind of probe used. **ntC**=NTC, **PtC**=PTC.
- rEL** Release code (read only).
- Ptb** Parameter code (read only).

15. PRINTER MANAGEMENT (IF PROVIDED AND CONFIGURED)

The **XB590L** can be connected to an approved **Dixell** printer by means of the output RS232. It is then possible to print the registered temperatures of the different probes during the chilling cycle, the duration of every single phase of the cycle and its entire duration. The date and time when the cycle is run.

15.1 XB07PR – KIT (OPTIONAL)

- The XB07PR kit is composed by:
1. Printer
 2. Power adapter
 3. Connecting cables

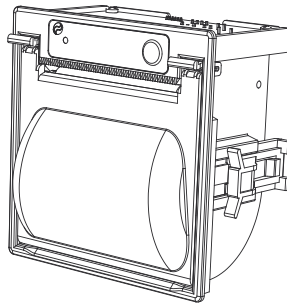

15.2 XB07PR - DIMENSIONS

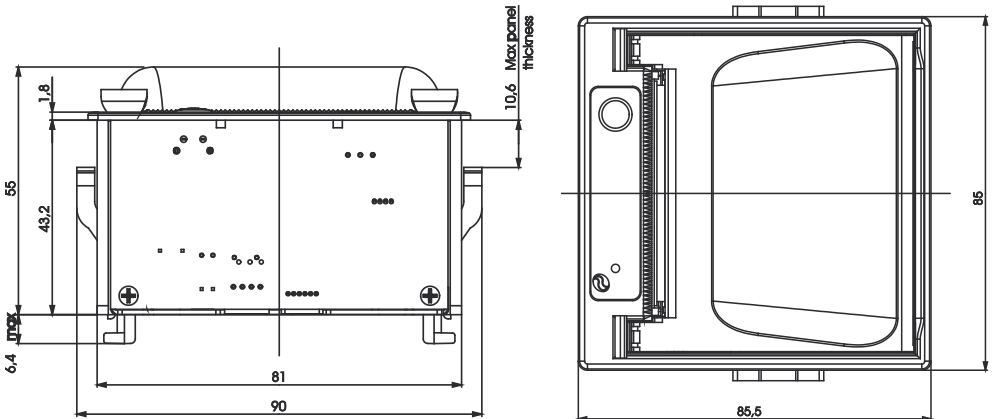

15.3 XB07PR – MOUNTING

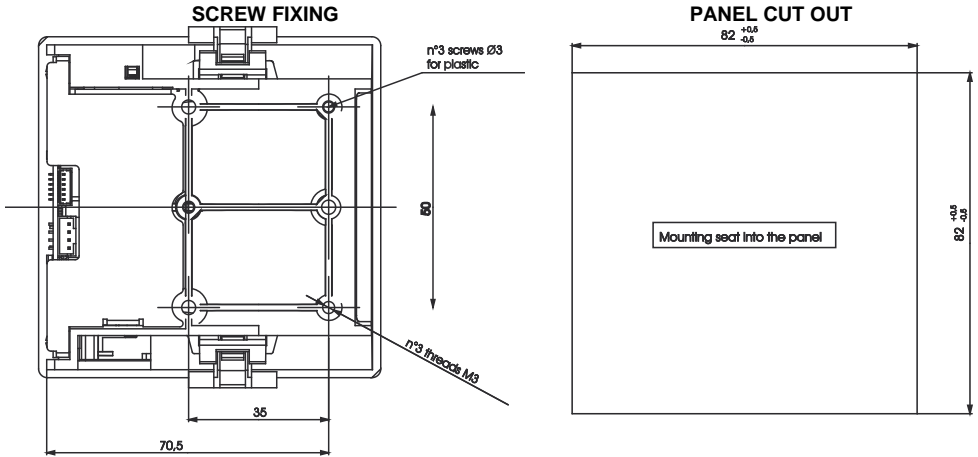

15.4 CONNECTION TO THE XB590L – XB07PR

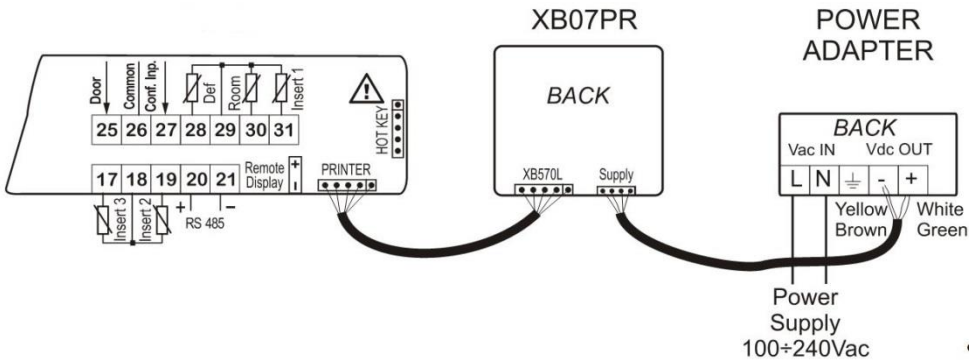

15.5 PRINTER SETTING

PRINT ENABLING

The printer can be enabled by pressing the key .

PRINTING PARAMETERS

By pressing the same key for 5s, the printer parameters can be programmed:

itP: printing interval: (0.1÷30.0 min; ris. 10s).

PbP: Information to be printed:

iP: Only insert probes present;

rP: Only room probe;

irP: Insert probes present and room probe;

ALL: all the probes;

PAr: print parameters map;

Cyc: print the parameters related to cycles setting

PtH: **yES**=print also during the hold phase; no=during the hold phase the printer is disabled.

PrS: parameters of level Pr1 or Pr2

Pnu: cycle number: (0÷999) the parameter is increased at each cycle.

```
* START CYCLE 3
DATE : 13/05/2015
PROBES REPORT 15:19
Insr.Probe : - 1.4°C
Room Probe : -22.6°C
PROBES REPORT 15:20
Insr.Probe : - 2.4°C
Room Probe : -22.6°C
START PHASE 1 15:20
Room SET : -30.0°C
I.Prb SET : -18.0°C
TIME : 240 min
PROBES REPORT 15:25
Insr.Probe : - 2.6°C
Room Probe : -22.6°C
PROBES REPORT 15:30
Insr.Probe : - 2.6°C
Room Probe : -23.6°C
PROBES REPORT 15:35
Insr.Probe : - 3.4°C
Room Probe : -25.6°C
PROBES REPORT 15:40
Insr.Probe : - 4.2°C
Room Probe : -28.6°C
```

16. ELECTRICAL CONNECTIONS

The instruments are provided with a screw terminal block to connect cables with a cross section up to 2.5mm² for probes and digital input.

Spade on 6.3 mm heat-resistant wiring for supply and loads. Before connecting cables make sure the power supply complies with the instrument's requirements. Separate the input connection cables from the power supply cables, from the outputs and the power connections. Do not exceed the maximum current allowed on each relay, in case of heavier loads, a suitable external relay has to be used.

N.B. The maximum total current on the loads shall not exceed 20A.

16.1 PROBES CONNECTION

The probes shall be mounted with the bulb upwards to prevent damages due to casual liquid infiltration. It is recommended to place the thermostat probe away from air streams to correctly measure the average room temperature. Place the defrost termination probe among the evaporator fins in the coldest place, where most ice is formed, far from heaters and from the warmest place during defrost, to prevent premature defrost termination.

17. SERIAL LINE

The instruments of the XB line are endowed with a serial output, which can be TTL or RS485 (optional). The serial line TTL, by means of an external module TTL/RS485, enables the interfacing with a compatible ModBUS-RTU monitoring system such as XWEB3000, or XWEB500 (Dixell).

By using the same serial output, it is possible to load and download the whole parameter list with the **“HOT KEY”** programming key.

Upon request, the instruments can also be supplied with the RS485 direct serial connection (optional).

It is possible, through the WIZMATE (Dixell) software, to manage the device parameters via a computer.

18. USE OF THE PROGRAMMING “HOT KEY “

18.1 DOWNLOAD (FROM THE “HOT KEY” TO THE INSTRUMENT)

1. Turn OFF the instrument by means of the ON/OFF key, remove the TTL serial cable if present, insert the **“Hot Key”** and then turn the Wing ON.
2. Automatically the parameter list of the **“Hot Key”** is downloaded into the Wing memory, the **“DoL”** message is blinking. After 10 seconds the instrument will restart working with the new parameters.
3. Turn OFF the instrument, remove the **“Hot Key”**, plug in the TTL serial cable and then turn it ON again. At the end of the data transfer phase the instrument displays the following messages:
 - **End** for right programming. The instrument starts regularly with the new programming.
 - **Err** for failed programming. In this case turn the unit off and then on if you want to restart the download again or remove the **“Hot key”** to abort the operation.

18.2 DOWNLOAD PROCEDURE OF PARAMETERS FROM THE INSTRUMENT TO THE USB KEY

1. Turn OFF the instrument by means of the ON/OFF key and remove the TTL serial cable if present; then turn it ON again.
2. When the unit is ON, insert the **“Hot Key”** and push the **UP** key; the **“UPL”** message will appear.
3. Push **SET** key to start the UPLOAD; the **“UPL”** message will start blinking.
4. Turn OFF the instrument, remove the **“Hot Key”**, plug in the TTL serial cable and then turn it ON again. At the end of the data transfer phase the instrument displays the following messages:
 - **End** for right programming. The instrument starts regularly with the new programming.
 - **Err** for failed programming. In this case turn the unit off and then on if you want to restart the download again or remove the **“Hot key”** to abort the operation.

19. TECHNICAL DATA

Housing: self extinguishing ABS

Case: frontal 38x185 mm; depth 76 mm

Mounting: panel mounting on a 150x31 mm hole, with 3 x 2mm screws, distance between holes of 165mm.

Protection: IP20

Frontal protection: IP65 (with front seal, mod. RG-L)

Connections: screw terminal for conductors $\leq 2,5$ mm², resistant to heat for extra-low voltage component

Male Faston 6,3mm, resistant to heat for low-voltage component (110 0 230Vac)

Power supply: 230Vac opp. 110Vac $\pm 10\%$, 50/60Hz

Power absorption: 7VA max

Display: three digits, red LEDs, height 14,2 mm

Inputs: 5 PTC or NTC probes

Digital inputs: door and configurable, voltage-free contacts

Outputs on relay: **total current on loads MAX 20A**

compressor: relay SPST 20(8)A or 8(3) A, 250Vac

defrost:: relay 8(3)A, 250Vac

fans: relay SPST 8(3)A, 250Vac

Light : relay SPST 16(6)A, 250Vac

Aux1 : relay SPST 8(3)A, 250Vac

Aux2 : relay SPST 16(6)A, 250Vac

Serial output: RS232 serial output for XB05PR printer connection

Serial output: RS485 serial output for monitoring system (MODBUS-RTU) protocol

Data storage: non-volatile memory (EEPROM)

Kind of action: 1B

Pollution degree: normal

Software class: A

Operating temperature: 0 to 60°C

Storage temperature: -25 to 60°C

Relative humidity: 20 to 85% (no condensing)

Measuring range:

NTC probe: -40 to 110°C (-40 to 230°F)

PTC probe -50 to 150°C (-55 to 302°F)

Resolution: 0.1°C or 1°F

Accuracy of the controller at 25°C: $\pm 0.5^\circ\text{C} \pm 1$ digit

20. STANDARD VALUES OF THE PARAMETERS.

Label	Value	Level	Description	Range
SEt	3	---	Set point	-50.0 to 50.0°C
Pr2	---	Pr1	not used	-
Hy	2.0	Pr1	Compressor hysteresis	0.1 to 12.0°C
AC	1	Pr2	Compressor restart delay	0 to 30 min
PAU	0	Pr2	Time of stand by	0 to 60 min
PFt	15	Pr2	Maximum acceptable duration of power failure	0 to 250 min
Con	15	Pr2	Compressor ON time with faulty probe	0 to 250 min
COF	10	Pr2	Compressor OFF time with faulty probe	0 to 250 min
rPo	0.0	Pr2	Thermostat probe calibration	-12.0 to 12.0°C
EPP	YES	Pr2	Evaporator probe presence	n; Y
EPo	0.0	Pr2	Evaporator probe calibration	-12.0 to 12.0°C
i1P	YES	Pr2	Insert probe 1 presence	n; Y
i1o	0.0	Pr2	Insert probe 1 calibration	-12.0 to 12.0°C
i2P	n	Pr2	Insert probe 2 presence	n; Y
i2o	0	Pr2	Insert probe 2 calibration	-12.0 to 12.0°C
i3P	n	Pr2	Insert probe 3 presence	n; Y
i3o	0	Pr2	Insert probe 3 calibration	-12.0 to 12.0°C
rEM	iPt	Pr2	Probe selection to stop chilling cycle	iPt; rPt
CF	°C	Pr2	Temperature measurement unit	°C; °F
rES	dE	Pr2	Resolution (for °C):	in; dE
Lod	rP	Pr2	Upper display view	rP; EP
rEd	rP	Pr2	View for rep	rP; EP; tiM; i1P; i2P; i3P
d1P	cL	Pr2	Door switch input polarity	OP; CL
odC	F-C	Pr2	Loads locked by door switch	no; FAn; CP; F-C
doA	5	Pr2	Open door alarm delay	da 0 a 254 min, 255=nu
dLc	Y	Pr2	Cycle block with open port	n; Y
rrd	Y	Pr2	Regulation restart after door open alarm	n; Y
d2F	EAL	Pr2	Second digital input function	EAL; bAL, ACy
d2P	cL	Pr2	Digital input polarity	OP; CL
did	5	Pr2	Time delay for digital input alarm	0 to 255min
oA1	tMr	Pr2	Configuration of first auxiliary relay	ALL; Lig; AUS; C2; tMr
oA2	ALL	Pr2	Configuration of second auxiliary relay	ALL; Lig; AUS; C2; tMr
oA3	Lig	Pr2	Configuration of third auxiliary relay	ALL; Lig; AUS; C2; tMr
2CH	C1	Pr2	Compressor setting during the holding	C1; C2; 1C2
OAt	3	Pr2	Second compressor switching on delay	0 to 255 min
OAS	0.1	Pr2	Set point for second compressor	-50.0 to 50.0°C
OAH	2.0	Pr2	Differential for second compressor	-12.0 to 12.0°C
OAI	rP	Pr2	Probe selection for second compressor	rP; EP; i1P; i2P; i3P
OSt	0	Pr2	Auxiliary output timer	0 to 255 min
OSS	0.0	Pr2	Output set point delta	-50.0 to 50.0°C
OSH	2.0	Pr2	Differential for auxiliary output	-12.0 to 12.0°C
OSi	rP	Pr2	Probe selection for auxiliary output	rP; EP; i1P; i2P; i3P
tdF	rE	Pr2	Defrost type	rE; in
idF	06:00	Pr2	Interval between defrost cycles	0.1 to 24h00min
dtE	8	Pr2	Defrost termination temperature	-50.0 to 50.0°C
MdF	20	Pr2	Maximum length for defrost	0 to 255 min
dFd	rt	Pr2	Temperature displayed during defrost	rt; it; SET; dEF
Fdt	0	Pr2	Drip time	0 to 60 min
dAd	20	Pr2	Temperature display time after defrost	0 to 120 min
FnC	c_n	Pr2	Fan operating mode during hold	o-n; C1n; C2n; Cn; o-Y; C1Y; C2Y; Cy

Label	Value	Level	Description	Range
FSt	30	Pr2	Fan stop temperature	-50.0 to 50.0°C
AFH	2.0	Pr2	Differential for the stop temperature and for the alarm	0.1 to 25.0°C
Fnd	2	Pr2	Fan delay after defrost	0 to 255 min
ALU	30	Pr2	Maximum temperature alarm	1.0 to 50.0°C
ALL	30	Pr2	Minimum temperature alarm	1.0 to 50.0°C
ALd	15	Pr2	Temperature alarm delay	0 to 255 min
EdA	30	Pr2	Alarm delay after defrost	0 to 255 min
tBA	Y	Pr2	Silencing alarm relay	n; Y
tCy	---	Pr1	Duration of last cycle	read only
tP1	---	Pr1	Duration of first phase	read only
tP2	---	Pr1	Duration of second phase	read only
tP3	---	Pr1	Duration of third phase	read only
Adr	1	Pr2	Indirizzo seriale	0 to 247
bUt	2	Pr2	Buzzer activation at the end of the cycle	0 to 60 sec
tPb	ntC	Pr2	Type of probe	ntC; PtC
Atc	150	Pr2	Absolute high condenser temperature threshold alarm	+50 to +150°C
btc	10	Pr2	Absolute low condenser temperature threshold alarm	+10 to +80°C
dAc	0	Pr2	Condenser alarm delay	1 to 250 sec (0=nu)
HyA	5.0	Pr2	Differential for condenser alarm (high and low)	0.1 to 12.0°C
bAc	n	Pr2	Machine shutdown with Atc alarm active	n; Y
bLc	n	Pr2	Machine shutdown with btc alarm active	n; Y
EPC	EP	Pr2	Evaporator probe configuration	EP, Co
i1c	i1	Pr2	Configuration insertion probe 1:	i1, Co
i2c	i2	Pr2	Configuration insertion probe 2:	i2, Co
i3c	i3	Pr2	Configuration insertion probe 3:	i3, Co
b2	Cy1	Pr2	Configuration key 2	nu, SSr, Cy1
b3	Cy2	Pr2	Configuration key 3	nu, SCy, Cy2
b4	Aus	Pr2	Configuration key 4	nu, Lig, AuS, OnF, dEf, Pm
b7	Hrd	Pr2	Configuration key 7	nu, Pm, Hrd, Cy3
b8	OnF	Pr2	Configuration key 8	nu, AuS, OnF, Lig, dEf
CCH	OFF	Pr2	Heating compressor carter	Only-OFF, ALL
CCt	0	Pr2	Compressor carter heating activation time	0 to 250 min (0=nu)
dCy	SC	Pr2	Start cycle by digital input d2F	SC, Cy1, Cy2, Cy3, Cy4
Ptb	---	Pr2	Parameters original map	read only
rEL	3.1	Pr2	Firmware release	read only
dP2	---	Pr2	Evaporator threshold value (if configured)	read only
dP3	---	Pr2	Condenser threshold value (if configured)	read only

Printer parameters menu			
itP	01:40	Printing interval	00:10+30:00 mins
PbP	irP	Information to be printed	iP; rP; irP; ALL
PAr	---	Print parameters map	-----
CyC	---	Print cycle parameters	-----
PtH	N	Print during conservation/holding	n - Y
PrS	Pr1	Printer Type	Pr1; Pr2
P_tim	EU	Date Format	EU; USA
Pnu	---	Number of cycles run	read only

20.1 CHILLING CYCLES

Cy1:	Soft chilling and hold cycle
Cy2:	Soft freezing and hold cycle
Cy3:	Hard chilling and hold cycle
Cy4:	Hard freezing and hold cycle

Label	CY1	CY2	CY3	CY4	Parameter description
cyS	tEP	tEP	tEP	tEP	Cycle setting
dbC	no	no	no	no	Defrost before cycle
iS1	3	3	10	-18	Set point for insertion probe for the first phase
rS1	0.0	0.0	-20.0	-35.0	Room set point for the first phase
Pd1	01:30	02:00	01:00	04:00	Cycle time for the first phase
iS2	3	-18	3	-18	Set point for insertion probe for the second phase
rS2	0.0	-35.0	0.0	-35.0	Room set point for the second phase
Pd2	00:00	02:00	00:30	00:00	Cycle time for the second phase
iS3	3	3	3	-18	Set point for insertion probe for the third phase
rS3	0.0	0.0	0.0	-35.0	Room set point for the third phase
Pd3	00:00	00:00	00:00	00:00	Cycle time for the third phase
dbH	yes	yes	yes	yes	Defrost before the conservation/holding phase
HdS	2.0	-20.0	2.0	-20.0	Set point of the conservation/holding phase

Dixell



Dixell S.r.l. - Z.I. Via dell'Industria, 27 - 32010 Alpago (BL) ITALY
Tel. +39.0437.9833 r.a. - Fax +39.0437.989313 - EmersonClimate.com/Dixell - dixell@emerson.com