

Applies to operating panel 10013402

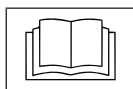

Read the installation instructions for the units and observe the safety information.

The target group for this installation manual is trained qualified personnel entrusted with the technical functioning and operation of the unit.

Safety instructions

Organizational measures

Risk of property damage and personal injury from lack of organizational measures

- Use equipment and protective gear suitable for the activity.

Danger of electric shock from live components.

- Prior to working on the electrical system, switch off the unit, disconnect the electrical system from the mains and prevent power from being switched on again. Check to ensure the system is dead.
- Use only insulated tools.

Check before replacing

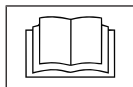

Troubleshoot using the service manual.

Test step
→ Ensure power is supplied to the operating panel.
→ Operation of the "/Off" switch. Check physical position of switch in the holder.
→ If error message "Faulty CAN connection". First replace the communication cable to the control board. If the error persists, replace the control board. The operating panel is the last option.
→ If there are traces of moisture in the electrical area, first eliminate the cause.
→ In case the date/time setting is lost, replace only the battery on the control panel.

Order of steps

- Backing up data if service menu can be accessed
- Exporting your own cooking programs to a USB stick (if available)

- Removing the operating panel
- Transferring the SD card to the new operating panel
- Attaching the film keypad
- Updating the software and importing additional content
- Setting the date and time
- Restoring data
- Importing your own cooking programs from a USB stick
- Loading optional OEM settings and selecting a cookbook

Preparing the USB stick

Prerequisite

- USB stick.
 - ↳ Maximum size 32 GB.
 - ↳ FAT formatting (default).
 - ↳ The disk should be empty if possible.
- Current software update and additional content
 - ↳ The update is available at the manufacturer's website.

INFORMATION

The additional content contains sound files and graphics. They must be installed after the operating panel has been replaced.

Preparing the USB stick

- Open and unzip the file "help_additional_mp.zip". In general, the unzipped folder is in the same directory as the previously compressed one.
- Copy the unzipped folders "MMIUpdate", "MMIContent" and "FCImport" from the USB stick to the root directory. The contents and folder structure must not be changed.

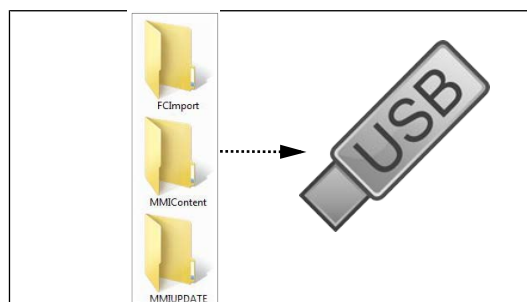

Replacing the control panel on FlexiCombi MagicPilot

Opening the Settings menu and Service menu

Replacement requires access to the Settings menu, Basic settings and Service menu.

Calling up the Setting menu

- Switch on the unit.
- Tap the "Unit functions" button.
 - ↳ Display of *Appliance functions* menu.
- Tap the "Settings" field.
 - ↳ Display of *PIN* window.
- Enter password "111" and tap the *Confirm* field.
 - ↳ Display of Device Settings menu.

Opening the Service menu

- Switch on the unit.
- Tap the "Unit functions" button.
 - ↳ Display of *Appliance functions* menu.
- Tap the "Settings" field.
 - ↳ Display of *PIN* window.
- Enter password "1967" and tap the *Confirm* button.
 - ↳ Display of the Service menu.

Backing up data

Backup function for parameters (for example, customer settings, calibration values). Saving data on the internal SD card and USB stick (if plugged in).

1. Open the Service menu as described.
2. Tap the "Backup data" field.
3. Touch the *Confirmation* field.
 - ↳ Backup data on the SD card.
 - ↳ A confirmation then appears on the touchscreen.
4. Tap the "OK" field.

Exporting your own cooking programs



- Switch on the unit.
- Insert the USB flash drive.
- Tap the "autoChef" button.
 - ↳ Display of *Automatic cooking (autoChef)* menu.
- Tap the "autoChef" button in the information strip.
 - ↳ Display of *autoChef* window.
- Tap the "Export cooking programs" field.
- Tap the *Confirm* button.
 - ↳ All user-created cooking programs are exported to the USB stick from the cookbook.
 - ↳ A confirmation then appears on the touchscreen.

Opening the control panel

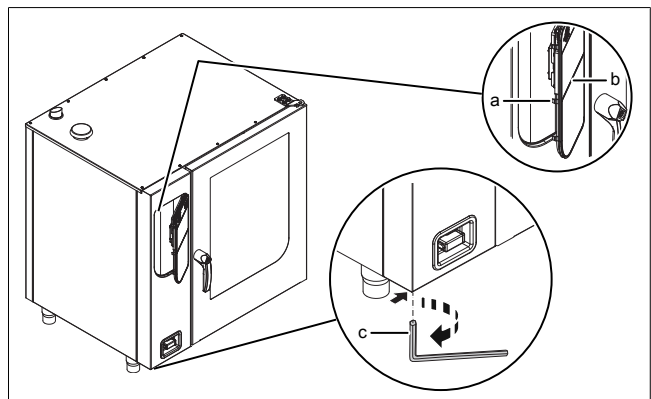
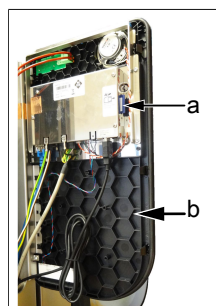

Image: Opening the control panel

- a Lock (cam)
 - b Operating panel
 - c Hex key
1. Insert hex key (5 mm) into screw and turn it clockwise.
 - ↳ The operating panel is now unlocked.
 - ↳ The operating panel pops up automatically.
 2. Withdraw the hex key.

Removing the operating panel



- a SD card
- b Operating panel

- Disconnect all lines on the control panel.
- Remove the SD card.
- Remove USB Bluetooth receiver (option).
- Remove operating panel by lifting.

Attaching the film keypad



a Per area of operating panel without foil

- Prepare the new operating panel. Affix included foil.

Installing the control panel

Reassembly is carried out in reverse order.

- Insert the SD card removed previously.

Closing the control panel

Close the control panel by repeatedly pressing the left side (particularly in the upper left). The control panel locks noticeably at multiple points.

NOTICE

Damage due to vapor / moisture

There should be no gap between the control panel and housing.

Updating the software

- Insert the USB stick
- Switch on the unit.
 - ↳ Follow the instructions on the touchscreen

INFORMATION

The update can take up to 15 minutes.

- ↳ A confirmation then appears on the touchscreen
- Tap the "OK" field
 - ↳ The software restarts automatically

INFORMATION

After the update, a blue screen may appear and the software does not start. In this case, switch the unit off and then back on. In rare cases, this may happen again.

Import additional content

- Insert the USB stick.
- Open the Service menu as described.
- Select the field "Import additional contents" on the left area of the menu by swiping.
- Tap the "Import additional contents" field.
- Tap the "OK" field.
 - ↳ The data is imported.
- A confirmation then appears on the touchscreen.
- Tap the "OK" field.

Restoring data

1. Open the Service menu as described.
2. Tap the "Restore data" field.
3. Touch the *Confirmation* field.
 - ↳ Restore data from the SD card.
 - ↳ A confirmation then appears on the touchscreen.
4. Tap the "OK" field.

Importing your own cooking programs

- Switch on the unit.
- Insert the USB flash drive.
- Tap the "autoChef" button.
 - ↳ Display of *Automatic cooking (autoChef)* menu.
- Tap the "autoChef" button in the information strip.
 - ↳ Display of *autoChef* window.
- Tap the "Import cooking programs" field.
- Tap the *Confirm* button.
 - ↳ All cooking programs on the USB stick are imported to the cookbook.
 - ↳ A confirmation then appears on the touchscreen.

Replacing the control panel on FlexiCombi MagicPilot

Settings

Setting the date and time



Prerequisite

- Open the Settings menu as described.
- Tap the "Set date and time" field.
 - ↳ The *Setting* window opens.
 - ↳ The *Keyboard* opens.
- Enter the date and time.
- Tap the Confirm button.
 - ↳ The *Keyboard* closes.
- ↳ The date and time are set.

OEM settings

Loading settings

INFORMATION

An OEM configuration may be required on units of key accounts.

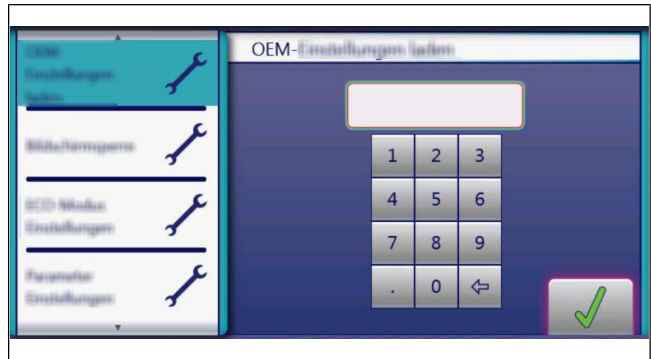

- Open the Settings menu as described.
- Wipe to select the page with the "Load OEM settings" field in the left menu area.
- Tap the "Load OEM settings" field.
- Enter the OEM code and tap the *Confirm* field.
 - ↳ The data is loaded.
- ↳ The software restarts automatically.

Select cookbook

INFORMATION

After the OEM settings have been loaded, select the cookbook.

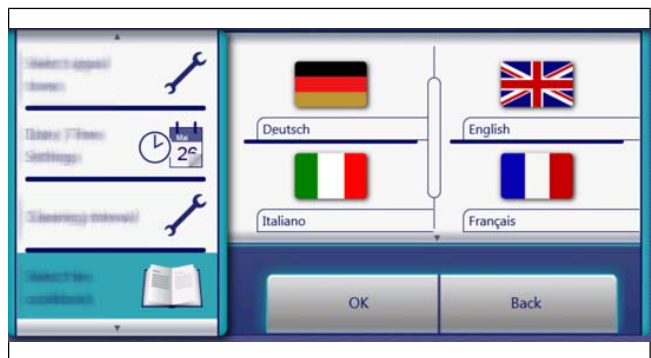

- Open the Settings menu as described.
- Wipe to select the page with the "Load OEM settings" field in the left menu area.
- Tap the "Select cookbook" field.
- Select the cookbook and confirm with OK.
- Press the *On Off* button to restart the unit.
- ↳ After the restart, the software jumps directly to the Favorites display.