

# 255 / LOGIX 740 - 760



**Operation Manual**  
Start up and Maintenance

**En**

**2**

## SYNOPSIS

En

Valve Features .....	4
LCD Display .....	5
<b>Installation .....</b>	<b>6</b>
Location selection .....	6
Water line connection .....	6
Drain line connection .....	7
Overflow line connection .....	8
Regenerant line connection .....	8
<b>Start-up of your softener .....</b>	<b>9</b>
Step 1 - Program system size .....	9
Step 2 - Placing conditioner into operation .....	9
Step 3 - Basic programming .....	11
World LOGIX settings .....	14
Step 4 - Capacity .....	15
Step 5 - Hardness setting .....	15
Resetting the control to unprogrammed .....	15
Manual regenerations .....	15
Options .....	16
Flow diagrams .....	18
Valve exploded view .....	20
Nomenclature .....	21

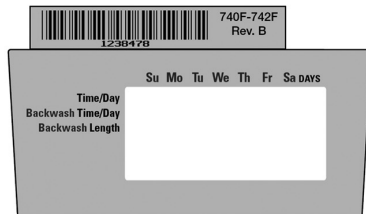
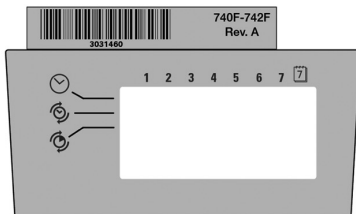
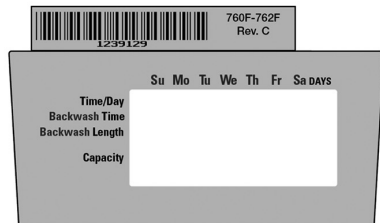
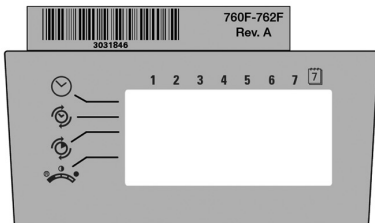
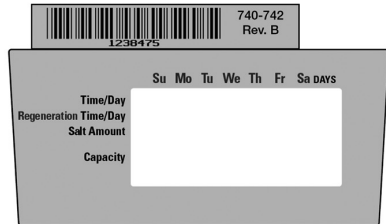
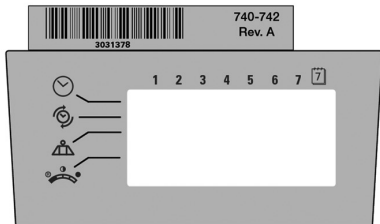
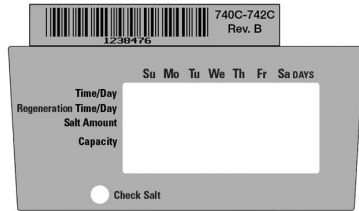
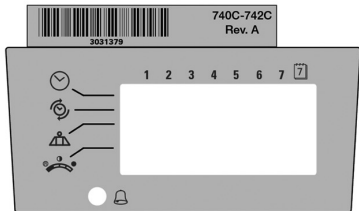
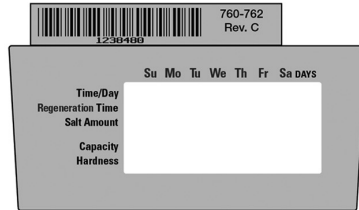
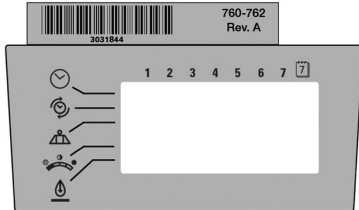
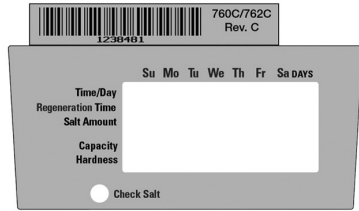
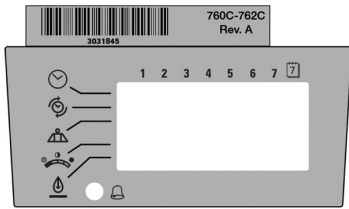

## Complete Valve - Front view

En

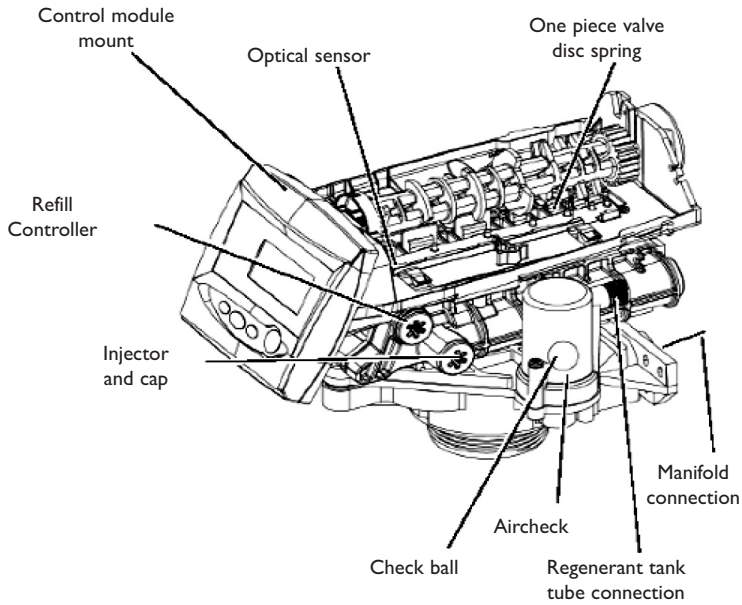

## Complete Valve - Back view

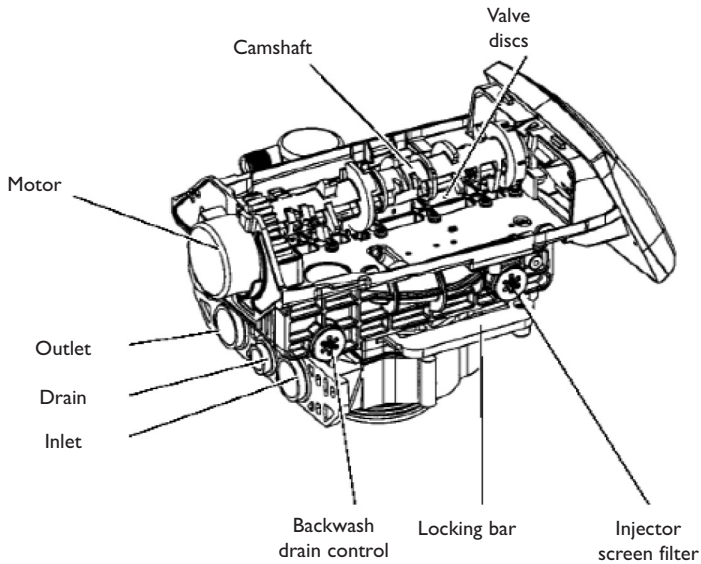

# LCD Display

LCD Display

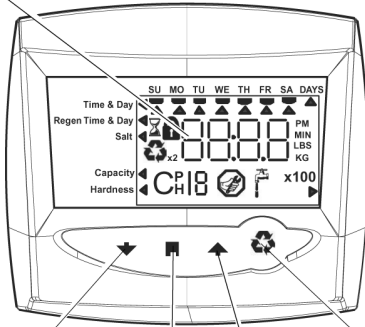

Down button

Set button

Up Button

Manual regen button

Chlorine generator outlet  
(EU and 742/762 versions only)

Lockout connection  
(772 only)

AC adapter input  
(low voltage)

Secondary valve motor control  
(772 only)

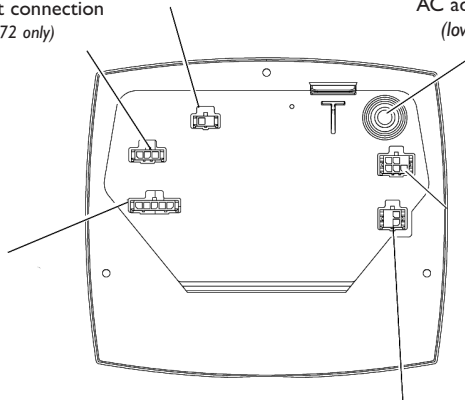

Sensor input 716  
by turbine 760/762  
Dry contact signal input 740/742

# INSTALLATION

En

## Location selection

Location of a water treatment system is important. The following conditions are required :

- Level platform or floor.
- Room to access equipment for maintenance and adding regenerant (salt) to tank.
- Ambient temperatures over 34°F (1°C) and below 120°F (49°C).
- Water pressure below 120 psi (8.27 bar) and above 20 psi (1.4 bar).
- Constant electrical supply to operate the controller.
- Total minimum pipe run to water heater of ten feet (three meters) to prevent backup of hot water into system.
- Local drain for discharge as close as possible.
- Water line connections with shutoff or bypass valves.
- Must meet any local and state codes for site of installation.
- Valve is designed for minor plumbing misalignments. Do not support weight of system on the plumbing.
- Be sur all soldered pipes are fully cooled before attaching plastic valve to the plumbing.

## Water line connection

A by-pass valve system should be installed on all water conditioning systems. Bypass valves isolate the conditioner from the water system and allow unconditioned water to be used. Service or routine maintenance procedures may also require that the system is bypassed. Figure 1 and 2 show the three common bypass methods.

**Figure 1**  
256 By-pass for use  
with 255 valve body.

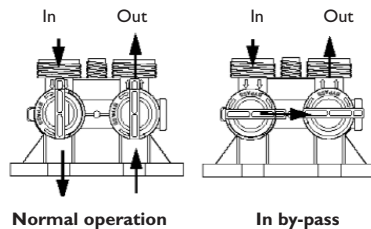

**Figure 2**  
Typical globe valve  
by-pass system

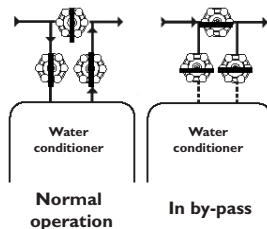

## Drain line connection

En



**NOTE** : Standard commercial practices are expressed here. Local codes may require changes to the following suggestions. Check with local authorities before installing a system.

1. If the backwash flow rate exceeds 5 gpm (22.7 Lpm) or if the unit is located 20-40 feet (6.1-12.2 m) from drain, use 3/4-inch (1.9 cm) tubing. Use appropriate fittings to connect the 3/4-inch tubing to the 3/4-inch NPT drain connection on valve.
2. The drain line may be elevated up to 6 feet (1.8 m) providing the run does not exceed 15 feet (4.6m) and water pressure at the conditioner is not less than 40 psi (2.76 bar). Elevation can increase by 2 feet (61 cm) for each additional 10 psi (0.69 bar) of water pressure at the drain connector.
3. Where the drain line is elevated but empties into a drain below the level of the control valve, form a 7-inch (18 cm) loop at the far end of the line so that the bottom of the loop is level with the drain line connection. This will provide an adequate siphon trap.

Where the drain empties into an overhead sewer line, a sink-type trap must be used.

Secure the end of the drain line to prevent it from moving.

**Figure 3**  
*Drain line connection*

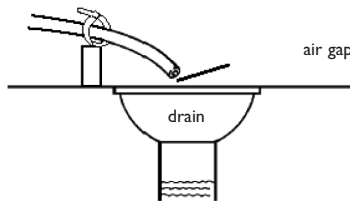

**WARNING** : Never insert drain line directly into a drain, sewer line or trap (figure 3). Always allow an air gap between the drain line and the wastewater to prevent the possibility of sewage being back-siphoned into the conditioner.

## Overflow line connection

En

In the event of a mal function, the regenerant tank overflow will direct “overflow” to the drain instead of spilling on the floor. This fitting should be on the side of the cabinet or regenerant tank. Most tank manufacturers include a post for the tank overflow connector.

To connect the overflow line, locate hole on side of tank. Insert overflow fitting into tank and tighten with plastic thumb nut and gasket as shown (figure 4). Attach length of 1/2-inch (1.3 cm) I.D. tubing (not supplied) to fitting and run to drain. Do not elevate overflow higher than overflow fitting.

Do not tie into drain line of control unit. Overflow line must be a direct, separate line from overflow fitting to drain, sewer or tub. Allow an air gap as per drain line instructions.

Figure 4

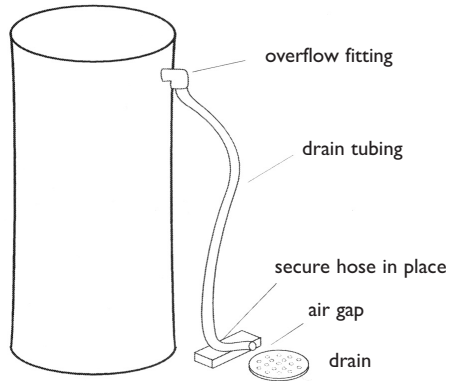

## Regenerant line connection

The regenerant line from the tank connects to the valve. Make the connections and hang tighten. Be sure that the regenerant line is secure and free from air leaks. Even as small leak may cause the regenerant line to drain out, and the conditioner will not draw regenerant from the tank. This may also introduce air into the valve causing problems with the valve operation.

Figure 5

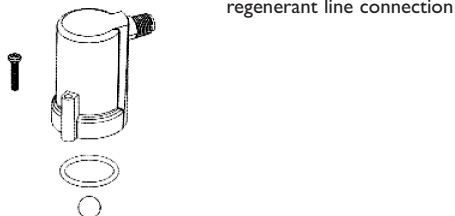



# START-UP OF YOUR SOFTENER

En

## Preliminary check of hydraulic parameters of the valve

This step must have been done by your OEM. You need to check that there is no mistake. In fact, every setting stored in the electronic is largely dependant of hydraulic parameters (injector/backwash) installed on the valve.

Please check that you are using the correct injector and backwash control in accordance with the used pressure tank (see table page 14).

## Initial start-up step-by-step instructions

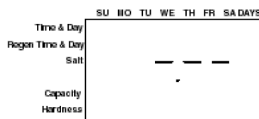

### Step 1 - Program system size

This step may be performed by your system's OEM manufacturer. In this case, proceed to step 2.

- Input system size - resin volume - in cubic feet or liters.
- Use UP and DOWN buttons to scroll through resin volume choices.
- Choose the nearest volume to your actual system size.
- To choose a 3-cycle filter operation - press the DOWN button until an "F" is displayed.
- Press the SET button to accept the system size you've selected.

If incorrect setting is programmed, see "Resetting the control" on page 15.

### Step 2 - Placing conditioner into operation (conditioner start-up)

After you have performed the previous initial power-up steps, you will need to place the conditioner into operation. Follow these steps carefully, as they differ from previous Autotrol valve instructions.

1. Remove the cover from the valve. Removing the cover will allow you to see that the camshaft is turning, and in which cycle the camshaft is currently positioned.
2. With the supply water for the system still turned off, position the bypass valve to the "not in bypass" (normal operation) position.
3. Hold the REGEN button on the controller down for 5 seconds. This will initiate a manual regeneration.

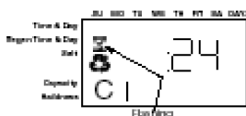

The controller will indicate that the motor is turning the camshaft to the cycle C1 (backwash) position by flashing an hourglass. The controller will display the total regen time remaining.

If you press and hold the SET button, the controller will indicate the time remaining in the current cycle.

**4.** Fill the media tank with water.

- A.** While the controller is in cycle C1 (backwash), open the water supply valve very slowly to approximately the 1/4 open position.
- B.** When all of the air has been purged from the media tank (water begins to flow steadily from the drainline), open the main supply valve all of the way. This will purge the final air from the tank.
- C.** Allow water to run to drain until the water runs clear from the drain line. This purges any refuse from the media bed.
- D.** Turn off the water supply and let the system stand for about five minutes. This will allow for any air trapped to escape from the tank.

**5.** Add water to the regenerant tank (initial fill) - *Conditioner only.*

- A.** With a bucket or hose, add approximately 4 gallons (15 liters) of water to the regenerant tank.
- B.** If the tank has a salt platform in the bottom of the tank, add water until the water level is approximately 1 inch (25 mm) above the platform.

**6.** Engage the refill cycle to prime the line between the regenerant tank and the valve  
*Conditioner only.*

- A.** Slowly open the main water supply valve again, to the fully open position. Be sure not to open too rapidly as that would push the media out the media tank.
- B.** Advance the controller to the refill position. From cycle C1 (backwash), press and hold the SET button. This will display the current cycle.

While pressing the SET button, press the UP arrow to advance to the next cycle. Continue to advance through each cycle until you have reached cycle C8 (refill).

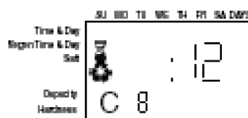

- C.** With the water supply completely open, when you arrive at cycle C8 (refill), the controller will direct water down through the line to the regenerant tank. Let the water flow through the line until all air bubbles have been purged from the line.

- D.** Do not let the water flow down the line to the tank for more than one to two minutes, or the tank may overflow.

- E.** Once the air is purged from the line, press the SET button and the UP button simultaneously to advance to cycle C0 (treated water) position.

**7.** Draw water from the regenerant tank.

- A.** From the treated water position (cycle C0), advance the valve to the draw regenerant position. Hold the REGEN button down for five seconds.

The controller will begin a manual regen, and advance the control valve to the cycle C1 (backwash). Press the SET and UP buttons to advance to cycle C2 (draw).

- B.** With the controller in this position, check to see that the water in the regenerant tank is being drawn out of the tank. The water level in the tank should recede very slowly.

- C. Observe the water being drawn from the regenerant tank for at least three minutes. If the water level does not recede, or goes up, reference the *Troubleshooting* section.
8. If the water level is receding from the regenerant tank you can then advance the controller back to the treated water (C0) position by pressing SET and UP buttons simultaneously to advance the controller to the C0 position.
  9. Finally, turn on a faucet plumbed after the water conditioner. Run the faucet until the water runs clear.

### Step 3 - 740/760 Basic Programming



**NOTE** : If a button is not pushed for thirty seconds, the controller returns to normal operation mode. Pushing the regenerate button immediately returns the controller to normal operation.

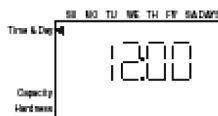

#### • Time of day

When the time of the day is displayed, push SET. The time will flash. Use the arrows buttons to increase/decrease the time. Push SET to enter the selection.

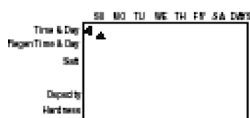

#### • Day of the week

The day of the week does not have a default setting. It is entered at power-up. To change the current day, push SET when day of week is displayed. A flag will flash beneath the current day. Use the arrow buttons to change. Push SET to enter the selection.

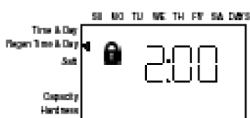

#### • Time of regeneration

This is set for 2:00 AM as the default. The controller does not account for daylight savings time. To change this setting, push SET. Use the arrow buttons to increase/decrease the time. Push SET to enter the selection.



#### • Number of days between regeneration

The controller can be programmed to regenerate automatically from a 1/2 (.5) day to a 99 day frequency. The 1/2 day regeneration mode will regenerate at the “time of regeneration”, as well as 12 hours opposite from that time. For example, the controller will regenerate at 2 AM and at 2 PM on the same day.

**740**

The default setting is three days for the 740. To change, push SET when this setting is displayed. Use the arrow buttons to increase/decrease. Push SET to enter the selection.

**760**

The default setting is 0 days for the 760. To change, push SET when this setting is displayed. Use the arrow buttons to increase/decrease. Push SET to enter the selection.

- **Specific day of week regeneration (740 only)**

To change the controller to regenerate on specific days, set the number of days between regeneration to zero.

After this has been completed, the arrow on the left side of the display will be pointing to regeneration time/day. Press the SET button and the display will show a flashing cursor at the top under Sunday. The day of week can be selected when the cursor is below it.

**740**

To toggle the day on/off, the triangular cursor must be below that day and flashing.

The UP or DOWN buttons are used to turn the days flag on/off. If the cursor is in position but steady on, use the UP or DOWN buttons.

To move the cursor when it is flashing push the SET button once. This will move the cursor one position to the right and change the status to steady on.



**WARNING** : Setting days between regeneration to zero will cause the system to not regenerate. This setting is used for selecting regeneration on specific days or to use with a remote regeneration input. See below.



**NOTE** : Regeneration on specific day is used to provide regeneration when water demands are not steady. Example : if the weekdays have low usage and the weekend is high, then regeneration every three days will not meet the requirements.

- **Amount of regenerant used per regeneration**

If the installation is a 3-cycle filter, skip to **Filter Backwash Time**. The amount of regenerant does not apply.

The Logix series controllers are set-up to automatically calculate the capacity of the system by multiplying the resin/media volume that was entered earlier into the controller, with the regenerant amount entered by the dealer/installer. This eliminates the need for salting efficiency tables.

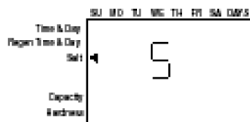

The default setting is “S” (Standard salt)

To enable the most simple programming possible on the 740 controllers, the dealer/installer has three salt amount options to choose from. These are set up to give the installation the maximum performance based on the inputs by the dealer/installer.

The three salting options are :



### High salt

This setting gives the installation the highest capacity possible for that resin volume. This is a great setting for applications with very high hardness, many occupants or for applications where the dealer wants to always ensure that the application has soft water. This setting may tend to use less water over the course of a year, because it generally needs to be regenerated less often. This setting is displayed as an “H”.

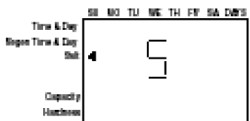

### Standard salt

This is the default setting for the controller. This setting fits most applications around the world. It gives you an efficient use of salt, while maintaining a large enough capacity to regenerate every three days for most applications.

This setting is displayed as an “S”.



### Low salt

This setting is provided to give your installation the maximum efficiency of salt usage, as measured in grains of hardness softened per pound of salt used (grams of CaCO<sub>3</sub> removed per kilogram of salt used). This setting is useful for markets where highly efficient conditioners are expected or required by the consumers or law.

This setting is displayed as an “L”.

## World Logix Settings

**En**

Tank Volume (liters)	Max Height	Inj.	Media Volume (liters)	Salt Setting	Total Salt Amount per regeneration (kgs)	Estimated capacity (kg)
6	18	E yellow	5	L	0,2	0,1
				S	0,45	0,2
				H	0,91	0,3
6	35	E yellow	10	L	0,45	0,3
				S	0,91	0,4
				H	1,81	0,5
7	44	F peach	15	L	0,68	0,4
				S	2,04	0,8
				H	3,40	1,0
8	44	G tan	20	L	1,13	0,7
				S	3,17	1,2
				H	4,98	1,5
9	48	H Lt purple	30	L	1,58	1,0
				S	4,08	1,6
				H	6,80	2,0
10	54	J Lt blue	35	L	1,80	1,2
				S	4,99	2,1
				H	8,62	2,5
12	54	K pink	40	L	2,27	1,5
				S	6,12	2,5
				H	10,20	3,0
13	54	L orange	50	L	2,94	2,0
				S	8,16	3,2
				H	13,61	3,9
14	65	L orange	80	L	4,53	3,0
				S	12,25	4,9
				H	20,41	5,8

H = High salt - approximately 15 lbs. per cu. ft. of media  
 S = Standard salt - approximately 9 lbs. per cu. ft. of media  
 L = Low salt - approximately 3.3 lbs. per cu. ft. of media

## Step 4 - Capacity

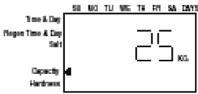

The 740 controller is designed to estimate capacity of the system by multiplying the initial resin/media volume by the regenerant amount programmed in under “Amount of regenerant used per regeneration”. An estimated total system capacity is displayed in kilograms (kilograms CaCO<sub>3</sub>) that can be removed by the fully regenerated media bed.

**This value is derived by standard water treatment industry norms.** The system capacity is displayed merely for the installers reference when determining regeneration frequency. This value is displayed, but cannot be directly changed of the 740 time clock controller.

- 740

  - Capacity is only displayed for information purposes on 740 control. It does not (and cannot) need to be changed. If using 740 control, programming is complete, the control will return you to the normal operation mode
- 760

  - To change capacity on 760 control, presse the SET button to make default capacity flash. Use the UP and DOWN buttons to increment to the desired capacity. Presse the SET button to accept the setting and advance to next parameter.

## Step 5 - Hardness setting (760 only)

The hardness setting is set in grains per gallon (ppm CaCO<sub>3</sub>). The hardness is divided into the total capacity setting, giving a total volume of water that can be conditioned before a regeneration is needed.

**760**

To set, press SET when P8 is displayed, and use the UP or DOWN buttons to increment. Press SET again to accept the setting.

## Resetting the control to unprogrammed

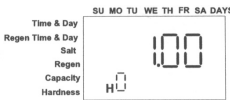

The control can be returned to its unprogrammed state. To erase all information that was programmed that :

1. Press the DOWN arrow and the SET button for five seconds.
  2. Press and hold the SET button for five seconds.
  3. The display will show three dashes and a decimal point.
  4. The display will be flashing.
- The display indicates all programming has been erased.

## Manual regeneration

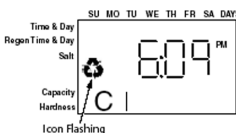

For a **delayed** regeneration (at the next set time of regeneration)

- Push the REGEN button once. The recycle symbol will be flashing on the display. Push the REGEN button again to cancel.

For an **immediate** regeneration :

- Push and hold the REGEN button for five seconds. The display will show the regeneration symbol. The camshaft will start rotating to cycle C1.

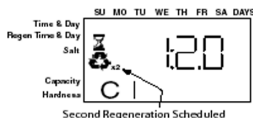

For an **immediate, double** regeneration :

- After an immediate manual regeneration has begun, and the camshaft has rotated to cycle C1, you can initiate a second immediate manual regeneration.
- Press and hold the REGEN button for 5 seconds once the camshaft has begun cycle C1.
- The display will show a x2 icon indicating that a second manual regeneration will occur after the current regeneration is completed.

## OPTIONS

### Logix Chlorine Generator (Check Salt Light)

The Logix 740C/742 and 760C/762 controls have the capability to produce a low level of chlorine to chlorinate the resin bed during regeneration. Included with the chlorine generator is the check salt light which indicates when the end user needs to add salt to the regenerant tank. Potassium chloride or sodium chloride may be used. Installing the chlorine generator is simple.

#### Installation instructions

- **STEP 1** - Remove the Logix control from the valve and disconnect power.
- **STEP 2** - Insert the small chlorine generator connector and wire to the back of the Logix control at the connection labeled "Chlorine Generator Outlet 740C/742 and 760C/742". Logix control removal procedure can be found in the Logix technical manual.
- **STEP 3** - Remove the existing refill controller and ball from the valve and replace it with the chlorine generator refill flow control. See the illustrations to the left for the location of the refill controller.
- **STEP 4** - Insert the small chlorine generator connector and wire to the back of the Logix control at the connection labeled "Chlorine Generator Outlet 740C/742 and 760C/742". Logix control removal procedure can be found in the Logix technical manual.
- **STEP 5** - Reconnect power to the logix control and reinstall the control to the valve

Chlorine Generator Outlet  
(740C/742 and 760C/742 versions only)

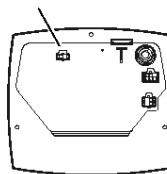

Back on Logix Control

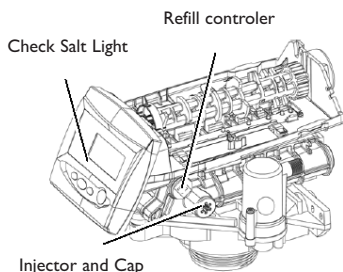

#### Programming

No programming is necessary for the chlorine generator to work properly on the 740C/760C. After the chlorine generator senses regenerant for the first time it will be functional. There is a check salt light on the front of the Logix control that will illuminate when there is no regenerant present during the regenerant draw.



## 255 Blending Valve Kit

Kit (P/N 1239760) for the 255/700 series includes :

- Nut (10-32) and Adjusting screw

### Installation

Insert the nut into the Blending Valve orifice located near the Bypass Flapper shown below. Insert the screw through the top plate and then through the nut (Figure A).

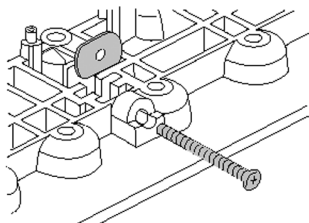

Figure A

Tighten the screw until it touches the Bypass Flapper (Fig. B).

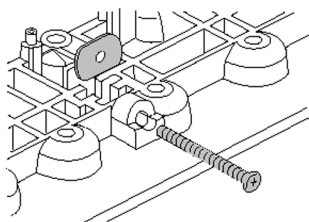

Figure B

### Operation

Tightening the adjusting screw will force the Bypass Flapper open. The open Flapper will allow untreated (hard) water to blend with the treated water supply. As the adjusting screw is turned in, the hardness of the outlet water increases (Fig. C).

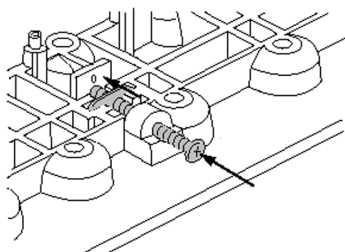

Figure C

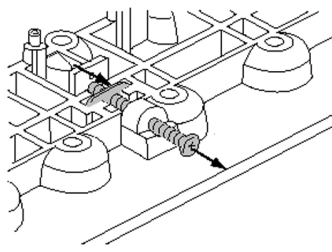

Figure D

Loosening the adjusting screw will allow the Bypass Flapper to close. The closing action will blend less untreated water into the outlet flow.

To blend a specific amount of hardness into outflow, adjust the screw and test the water. Repeat the procedure as needed until the desired hardness level is reached.

# Flow Diagram

En

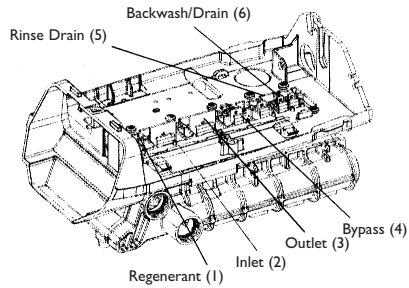

**C0 Treated water position**  
(normal position)

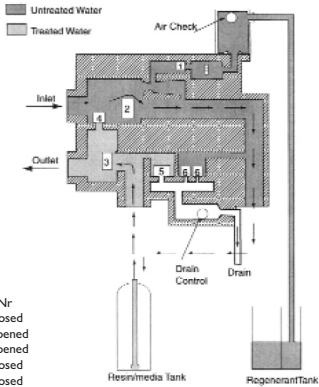

**C1 Backwash I position**

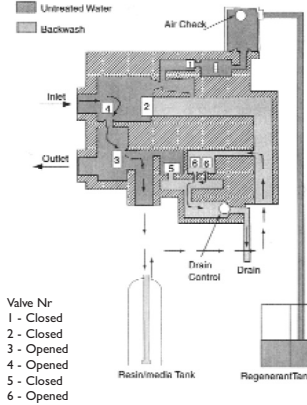

**C2 Draw position**

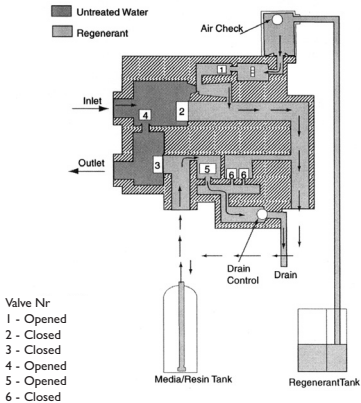

**C3 Slow Rinse position**

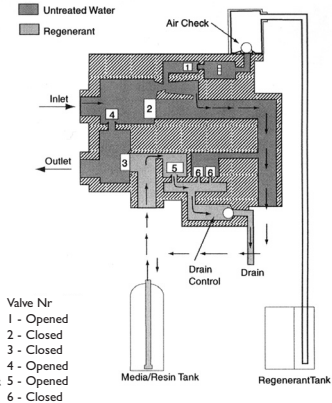

### C4 System Pause position (repressurize)

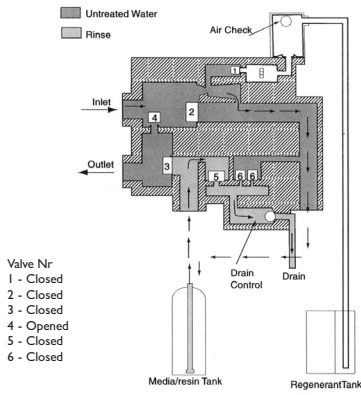

### C5 Fast Rinse 1 position

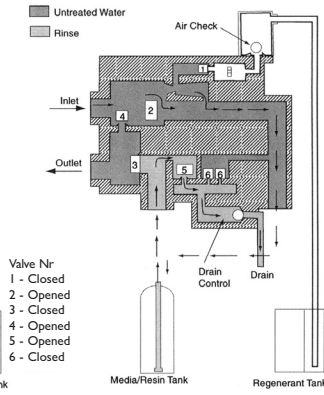

### C6 Backwash 2 position

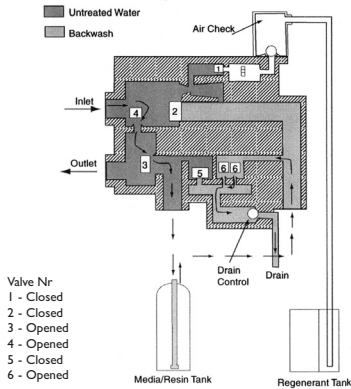

### C7 Fast Rinse 2 position

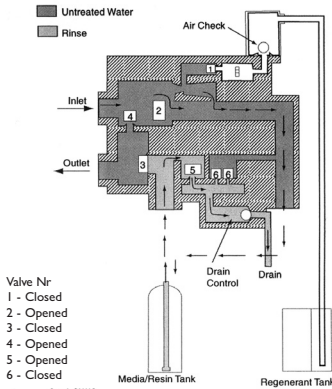

### C8 Refill

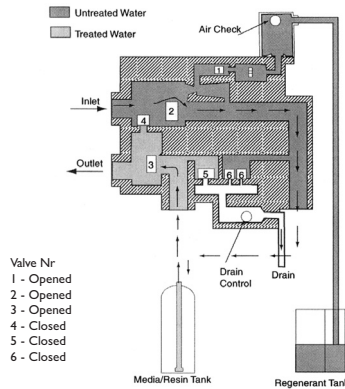

## 255 VALVE EXPLODED VIEW

En

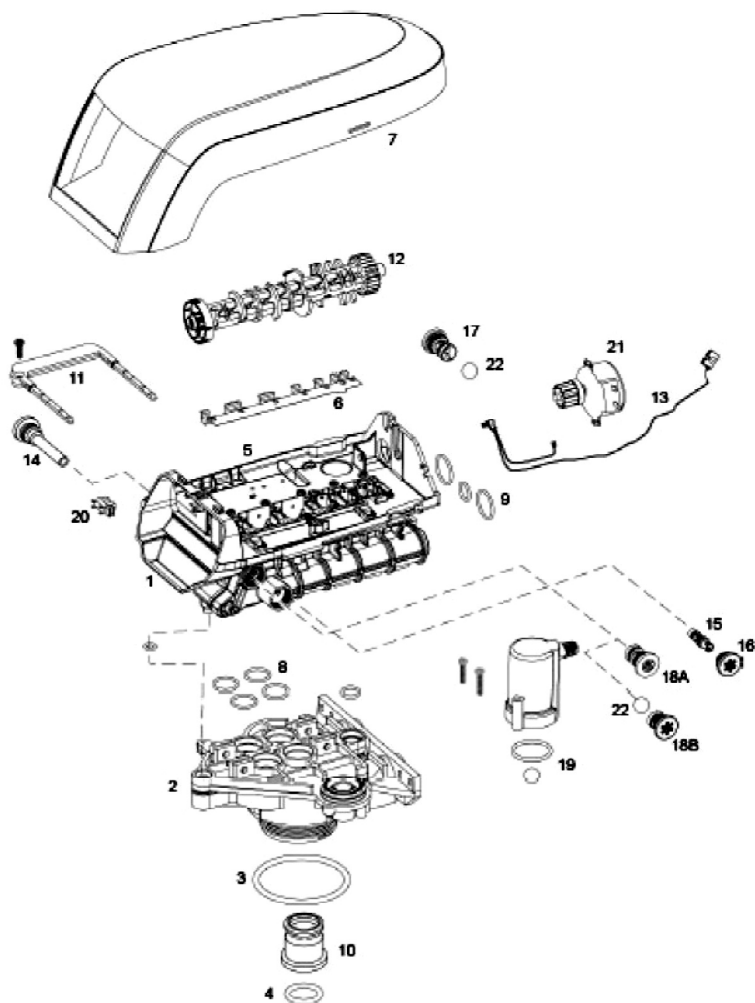

## 255 VALVE NOMENCLATURE

En

Code	Part number	Description	Qty
1	1294650	255 Valve Assembly, w/o flow controls	1
2	1033784	255 Tank adapter New style	1
3	1010429	O-Ring BN	1
4	1010428	O-Ring EP	1
5	1235640	Top plate, 255 Valve, 700/860 Series controller	1
6	1235341	Spring One piece 255 valve	1
7	1236246*	Cover, Valve, 255/Performa, 700/860 Series controller	1
8	1001404	O-Ring group : tank adapter	1
9	1040459	O-Ring group : piping boss	1
10	1001986	13/16 inch rubber insert (optional)	1
*	1000250	Valve disk kit - standard	1
*	1239760	Blending valve kit 900/700 series top plate	1
11		Locking bar	1
	1031402	English language locking bar	
	1031403	French language locking bar	
	1031404	German language locking bar	
	1031405	Italian language locking bar	
	1031406	Japanese language locking bar	
	1031407	Spanish language locking bar	
	1006093	Locking bar screw N° 8-9/196 inch	
12		Camshaft options	1
	1235353	Cam 255/700-860 series valve, STD, black	
	1236251	Cam 255/700-860 series valve, TWIN, tan (insert)	
13	1236269	Motor/Optical cable assembly, 700 series controller	1
14	1000226	Screen/Cap Assembly w/ O-Ring	1
15		Injector (high efficiency) Options	1
	1035730	"E" Injector (high efficiency) - yellow	
	1035731	"F" Injector (high efficiency) - peach	
	1035732	"G" Injector (high efficiency) - tan	
	1035733	"H" Injector (high efficiency) - lt purple	
	1035734	"J" Injector (high efficiency) - lt blue	
	1035735	"K" Injector (high efficiency) - pink	
	1035736	"L" Injector (high efficiency) - orange	
16	1000269	Injector cap with O-Ring	1
17		Drain control assembly with O-Ring	1
	1000209	N°7 (1.2 gpm; 4.5 Lpm)	
	1000210	N°8 (1.6 gpm; 6.1 Lpm)	
	1000211	N°9 (2.0 gpm; 7.6 Lpm)	
	1000212	N°10 (2.5 gpm; 9.5 Lpm)	
	1002130	N°12 (3.5 gpm; 13.2 Lpm)	
	1000214	N°13 (4.1 gpm; 15.5 Lpm)	
	1000215	N°14 (4.8 gpm; 18.2 Lpm)	

## 255 VALVE NOMENCLATURE

**En**

Code	Part number	Description	Qty
18A	1000222	Regenerant Refill controller, No ball	1
18B	1243510	Regenerant Refill controller	
19		Air Check Kit	1
	1032416	Air Check Kit 3/8 inch male	
	1032417	Air Check Kit 1/4 inch male	
20	1235373	Module, Sensor, Photo interrupter	1
21	1238861	Motor w/Spacer & Pinion, 700 Series controller, 12V, 50/60 Hz	1
22	1030502	Ball Flow Control	1
*	1033066	New to Old Style Aircheck Adapter	1

## 740/760 Control

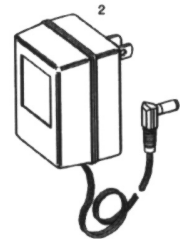
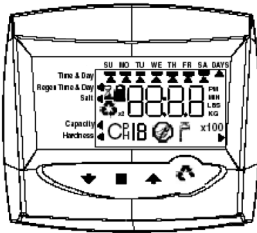

En

Code	Part Number	Description
1	1234336	Kit chlorine generator
2	1242411	Extension cable for remote blezel
3	1263910	Overlay 740
4	1263911	Overlay 740C
5	1263912	Overlay 740F
6	1263913	Overlay 760
7	1263914	Overlay 760C
8	1263914	Overlay 760F
9	1000814	Transformer

### Meter Adapter - Bypass Valve

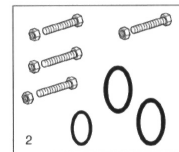
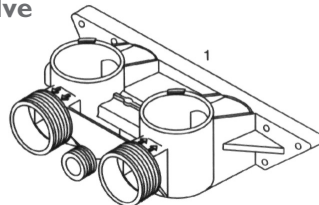

Code	Part Number	Description
1	1040769	By-pass
2	1040524	Installation Kit

### Meter Adapter

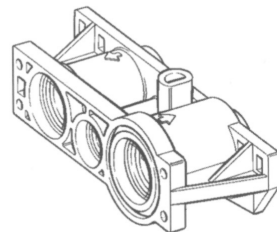
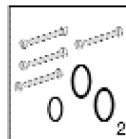

Code	Part Number	Description
1	1032351	Turbine + Installation Kit
2	1032350	Installation Kit