



GIX 5

GIX 8

GIX 12

**Manuale d'istruzioni
Instruction Manual
Notice d'Utilisation
Handbuch
Manual de Instrucciones**

Serie GIX

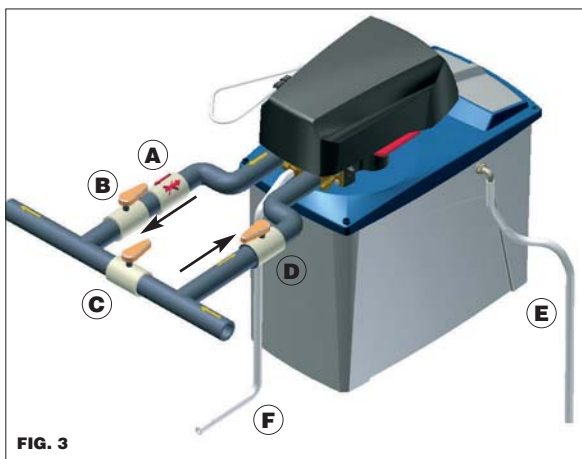
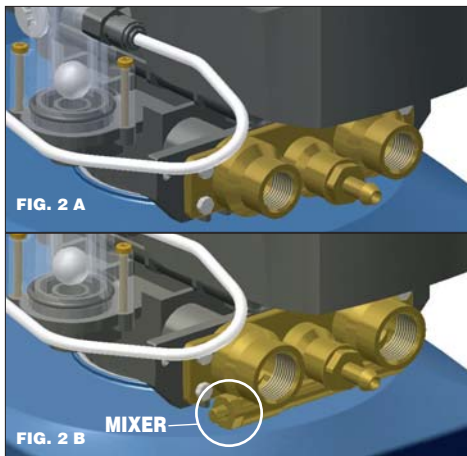

LEGENDA:

A valvola di non ritorno
B rubinetto uscita
C rubinetto by-pass
D rubinetto ingresso
E tubo per il troppo pieno
F tubo scarico

LEGEND:

A non-return valve
B outlet tap
C by-pass tap
D inlet tap
E overflow pipe
F unloading pipe

Posizione di lavoro:

Rubinetto B e D aperti
Rubinetto C chiuso

Working position:

Tap B and tap D open
Tap C closed

Posizione di by-pass:

Rubinetto B e D chiusi
Rubinetto C aperto

By-pass position:

Tap B and tap D closed
Tap C open

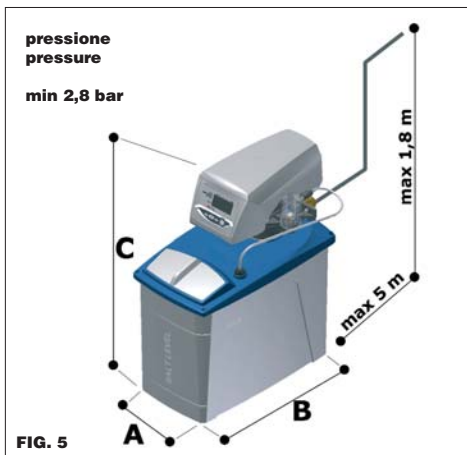
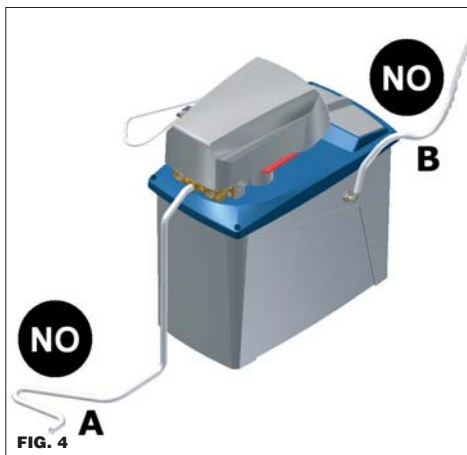

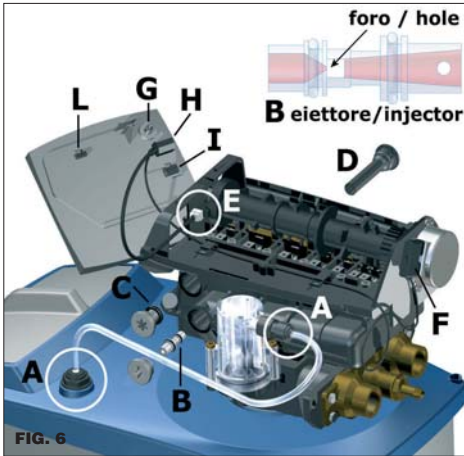

LEGENDA:

- A ATTACCHI RAPIDI
- B EIETTORE
- C REGOLATORE SALAMOIA
- D FILTRO EIETTORE
- E LETTORE OTTICO
- F CONNESSIONE MOTORINO
- G INGRESSO ADATTATORE
- H CONNESSIONE MOTORE E SENSORE OTTICO
- I INGRESSO PER TURBINA VOLUMETRICA (non utilizzato)
- L USCITA PER ELETTRODO DISINFEZIONE RESINE

LEGEND:

- A SPEED CONNECTIONS
- B INJECTOR
- C REFILL FLOW CONTROL
- D INJECTOR FILTER
- E OPTICAL SENSOR
- F MOTOR CABLE
- G AC ADAPTER Input
- H MAIN MOTOR & OPTICAL SENSOR Connection
- I TURBINE Input (not used)
- L CHLORINE GENERATOR Outlet

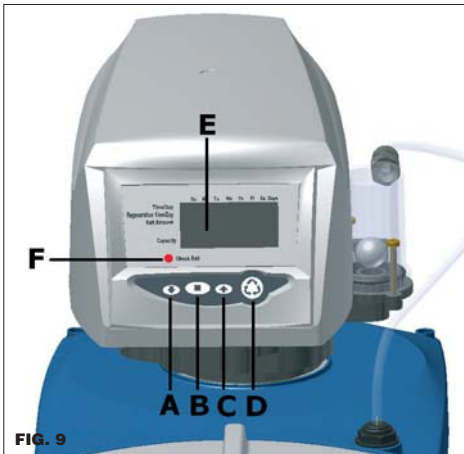
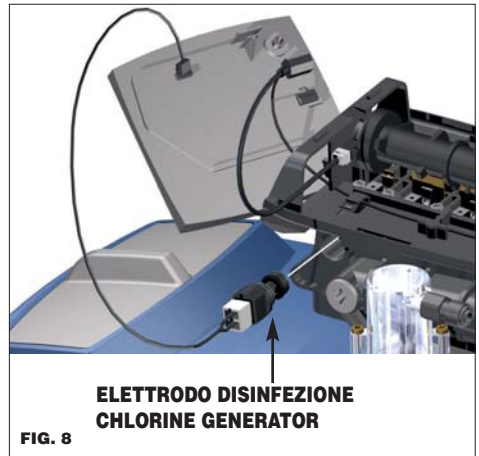

LEGENDA:

- A Pulsante SCENDI
- B Pulsante SET
- C Pulsante SALI
- D Pulsante AVVIO RIGENERAZIONE
- E DISPLAY LCD
- F LED ALLARME SALE

LEGEND:

- A DOWN button
- B SET button
- C UP button
- D MANUAL REGENERATION button
- E LCD DISPLAY
- F LED SALT ALARM

1) DEAR CUSTOMER,

thank you for purchasing our GIX Series water softener. Please set the water softener at work only after reading this instruction manual. In case of trouble, please contact your retailer for assistance. For future reference, keep this manual together with the water softener.

2) HOW DOES A GIX SERIES WATER SOFTENER WORK?

The GIX Series water softener, thanks to the ionic exchange resins contained inside the bottle, traps the Magnesium and Calcium salts dissolved in the water, removing water hardness in excess and preventing the formation of limescale. In order to guarantee a correct functioning of the resins, it is important to add salt to the pickle vat periodically (fig. 7).

3) THE PACKAGING CONTAINS:

- 1 GIX Series water softener with cationic resins adapt for softening
- 1 instruction manual
- 4 metres of unloading pipe
- 1 overflow curved union joint
- 1 hose fitting for the unloading pipe

4) TECHNICAL DATA

Size (fig. 5):	GIX5	GIX8	GIX12
A - Width [mm]:	230	250	285
B - Depth [mm]:	380	480	425
C - Height [mm]:	515	540	650
Weight [Kg]:	11	12	15
Salt for regeneration [Kg]	0,6	1	1,5
Salt in pickle vat [Kg]	10	20	25
Cyclic capacity [m ³ °f]	22	36	50

Power supply: 230V 50/60 Hz standard
 120V 60 Hz optional
 Supply water pressure: min 2 bar, max 8 bar
 Maximum flow rate recommended: 1500 l/h
 Room temperature: 4°-30°C
 Absorbed power: 4 W
 Water network connections: . . . 3/4" G with mixer;
 1/2" G; (fig. 2)

5) SUPPLY WATER FEATURES

- Drinking water
- Temperature: min 4°C – max 25°C
- Crystal clear water (SDI 1)
- Maximum hardness 90°f

6) SOFTENED WATER AMOUNT ACCORDING TO HARDNESS

MODEL	WATER HARDNESS					
	°f	20	30	40	50	60
	°d	11	16	22	28	33
	ppm CaCO3	200	300	400	500	600
GIX5		1050	700	525	420	350
GIX8		1680	1120	840	672	560
GIX12		2520	1680	1260	1008	840

7) SECURITY WARNINGS

Please read carefully the following warnings before installing the fixture:

1. Installation and maintenance must be carried out only by a qualified personnel, well practised with this kind of fixture and who thoroughly knows current local safety regulations;
2. Before installation, make sure the fixture is not faulty or damaged because of transport; failing this, please contact your retailer;
3. The water softener only guarantees the softening of cold drinkable water. Any other use is considered unreasonable;
4. Repair and maintenance must be carried out only with the original spare parts;
5. Do not expose the fixture to rain and damp;
6. Do not touch or use the water softener with wet or damp hands or feet, or barefoot;
7. Before connecting the fixture to the electric network, make sure the available line voltage corresponds to the voltage indicated by the tag on the fixture;
8. The electrical plants must be provided with a working earthing arrangement to prevent any danger;
9. Make sure the maximum pressure of the water network does not exceed 8 bar, otherwise please install a pressure reducer.

Should you not follow the above-mentioned warnings, the manufacturer is not responsible for any damage and/or injury.

8) INSTALLATION

8.1 POSITIONING

Choose the place where to position the fixture considering that:

1. the temperature of the place must range between 4°C and 30°C;
2. the water softener must be easily reachable, since salt must be loaded periodically in the pickle vat (fig. 7);
3. the distance between the water softener and the unloading system must be as short as possible.
4. the water softener must be put on a horizontal surface;
5. the flexible connection pipes must not be flattened or have too narrow elbows, so that water can flow out without running into obstacles;
6. if the water softener is close to a boiler, make sure pipes and the water softener itself don't overheat; if possible, keep at least a 3-metre piping between the outlet of the water softener and the boiler inlet.
7. do not install the water softener near acid or corrosive substances or fumes.

8.2 ELECTRIC NETWORK CONNECTION

Before plugging the fixture into the supply network, make sure the plug is compatible with the socket. This fixture was built in accordance with the essential safety requirements set by the following European regulations: **Low Voltage Directive 2006/95/CEE and 93/68/CEE (electrical safety), Electromagnetic compatibility 2004/108/CEE and 93/68/CEE (electrical safety). Installation must be carried out in accordance with the law on electrical plants (CEI 64.8).**

8.3 WATER NETWORK CONNECTION

Make sure the pressure of the water network ranges between 2 bar and 8 bar; if pressure is higher than 8 bar, the installation of a pressure reducer is required. If it is lower than 2 bar,

the water softener will not function properly. For a higher security, install a tap on the inlet pipe and another tap on the outlet pipe (fig. 3, B, D); this allows to stop the water in case of need.

Install a non-return valve (DVGW, DIN 1988 T2) on the water softener outlet (fig. 3, A) to prevent hot water to return to the softener as it may damage the fixture.

We advise you to perform the installation described in fig. 3, because it will allow you to use water in your fixture also during maintenance.

At the end of installation, before you open the inlet and outlet taps, the water softener must be set to work (see paragraph 11).

8.4 UNLOADING SYSTEM CONNECTION

While regenerating, the outgoing water must be unloaded being conveyed through a plastic flexible pipe (included in the package) and into the nearest unloading system.

Install the unloading pipe following the instructions below, as a poor installation will cause malfunctioning to the water softener:

- If possible, the unloading point must be at floor level;
- If the unloading point is placed higher than the water softener, the maximum height acceptable is 1.8 metres, provided that the distance is not longer than 5 metres and the pressure of the supply water network is at least 2.8 bar (fig. 5).
- Make sure the pipe is not flattened or bent, as water should flow out without running into obstacles (fig. 4, A);
- The unloading system must never be directly connected to a siphon or to other unloading pipes, in order to prevent returns or pollution into the water softener

8.5 PICKLE CONNECTION

The installer must make sure the connection between the valve and the pickle must be perfectly sealed and airtight (fig. 8, D).

8.6 OVERFLOW PIPE CONNECTION

Install the overflow union joint (included in the package) on the pickle vat, to allow the unloading of possible excess of water in the pickle that may be caused by irregular refill or defects in the functioning. Drill a hole in the pickle, tight the overflow union joint, insert the flexible pipe on the hose fitting, connect the pipe to an unloading system placed lower than the union joint, to allow the water to come out simply by falling rather than by pressure (fig. 3, E and fig. 4, B).

Do not connect the overflow pipe to the unloading pipe of the water softener, in order to prevent any possible return of water in the pickle.

9) SETTING THE TIMER

9.1 GIX SERIES

The GIX Series water softener can be programmed in a quick and easy way. It is provided with four buttons allowing to set time, day and salt amount for regeneration (fig. 9).

During service, the display shows the time, the current day, and, if programmed, the regeneration days.

During regeneration, the display shows the residual time until the end of the operation, and the current step (fig. 18).

9.2 PLUGGING IN THE FIXTURE

Plug in the fixture and connect the connector to the timer (fig. 6, G). The display (fig. 9, E) will show the time.

If "Err3" appears instead, wait for the valve to position to the

correct step. The error message will disappear and the display will show the time.

9.3 SETTING DAY AND TIME

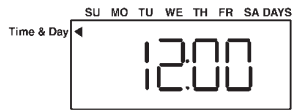

fig.10

- 1) Press **■** and the display will flash.
- 2) Using the buttons **↓↑** set the current time (fig. 10).
- 3) Press **■** to confirm.

Now, on the higher part of the display, a little triangle indicating the day will appear (fig. 11).

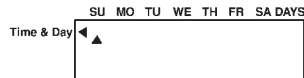

fig. 11

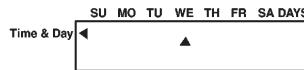

fig.12

- 1) Press **■** and the little triangle will flash.
- 2) Move it using the buttons **↓↑** up to the current day (fig. 12)
- 3) Press **■** to confirm.

9.4) SETTING REGENERATION TIME

On the left side of the display, a little triangle will point to the words "regen time".

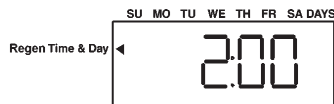

fig.13

- 1) Press **■** and the display will flash.
- 2) Using the buttons **↓↑** select the regeneration time (fig. 13).
- 3) Press **■** to confirm.

9.5 SETTING REGENERATION DAY

On the display, you will see a number indicating the lapse of time between a regeneration and the next, and a little triangle under the word "DAYS" (fig. 14).

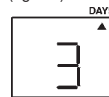

fig. 14

- 1) Press **■** and the display will flash.
- 2) Press the buttons **↓↑** to choose the number of days lapsing between a regeneration and the next. Values go from 0.5 to 99.

The value 0.5 means that two regenerations a day will be performed, one every 12 hours. For example, if "regeneration time" (see paragraph 9.4) is set at 17, the following regeneration will be performed at 5 a.m.

The other values go from 1 (one regeneration a day) to 99

(one regeneration every 99 days).
Press **■** to confirm.

If, instead, you wish to choose selected days of the week for the regeneration to be performed, use the buttons [symbol] to set the value 0 and follow the instructions below:

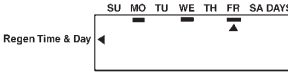

fig. 15

- 1) Press **■**. The "0" will disappear from the display, and a little triangle on the left side will point to the words "regen day".
- 2) Press **■**. Another little triangle will flash in the higher part of the display, right under the day SU (Sunday).
- 3) Press **■**. The little triangle will move to the following day, without flashing.
- 4) It's now possible, using the buttons **↓↑** to move it to the desired regeneration days.
- 5) Press **■** and the little triangle will flash.
- 6) Press **↑** to confirm, and the chosen day will be underlined. The regeneration will take place on the underlined days (fig. 15).
- 7) Press **■** to confirm.
- 8) Set the desired regeneration days.
- 9) Press and hold down **■** until a letter appears on the display (fig. 16).

9.6 MEASURING OUT SALT FOR REGENERATION



fig. 16



fig. 17

The value "salt amount" determines the regeneration time and the associated salt dose.

The value is set by the manufacturer and must be modified under the installer supervision.

- 1) After setting the regeneration days, a letter ("S", "L" or "H") will appear on the display.
- 2) Press **■** and the display will flash.
- 3) Using the buttons **↓↑** select **L** (fig. 17).
- 4) Press **■** to confirm.

End of settings.

9.7 SET DATA SAFEGUARD

In order to avoid set data to be modified, it is possible to block them using the following procedure:

Press and hold down **↓↑** at the same time, until "P1" appears on the lower part of the display. Pressing **↓** again, it is possible to run through all the parameters:

- P1 current time
- P2 current day
- P3 regeneration time
- P5 regeneration days
- P6 salt dosing
- P7 salt amount
- P9 measuring system (US/metric)
- P10 time settings 0-12 hours / 1-24 hours
- P11 salt alarm ON/OFF

To block a set value, press the button **⊞**.
A lock **⊞** will appear on the display.

The values can be unblocked following the same procedure.

9.8) NOTES ABOUT THE SETTING

If, during the setting or the data modification, no button is pressed for more than 20 seconds, the display will show back the current time.

In order to maintain the data during a power supply black out, the timer is provided with a buffer battery and can keep memory of them for 6 hours. After that, the data will have to be set again.

10) MANUAL SETTINGS

10.1 POSTPONED REGENERATION:

Pressing the button **⊞** the symbol **⊞** will flash on the left side of the display. This means that a regeneration will be performed at the set time, without any modification to the settings.

If you press the button, the command will be cancelled.

Pressing the button **⊞** during regeneration, the symbol "⊞ X2" will appear.

Also in this case, it means that a regeneration will be performed at the set time, without any modification to the program.

10.2 IMMEDIATE REGENERATION

To start an entire regeneration cycle immediately, press and hold down **⊞** for 5 seconds.

When regeneration starts, the display will show the minutes remaining to the end, and a "C", indicating the current regeneration step (fig. 18).

Regeneration is made up of 8 steps:

- C0 service
- C1 first backwash
- C2 salt injection and slow wash
- C4 ri-pressurization
- C5 first quick rinse
- C6 second backwash
- C7 second quick rinse
- C8 loading of water in the pickle

10.3 QUICK CYCLE:

To check the correct functioning of the different regeneration steps, follow the instructions below:

- 1) Press and hold down **⊞** for 5 seconds, and a manual regeneration cycle will begin.
- 2) Wait for a few seconds, until "C1" appears on the display. Press **■** if you wish to see the remaining minutes until the end of the step.
- 3) Pressing the buttons **■** and **↑**, at the same time, you will pass immediately to the following regeneration step, C2.
- 4) Pressing the buttons **■** and **↑**, at the same time, you will pass immediately to the following regeneration step, C4.

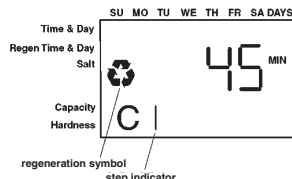

fig. 18









Repeating the operations described above, you will be able to run through all the cycle steps.

If you press and hold down **■** and **↑** at the same time for 5 seconds, the valve, whatever its position, will go past all the steps non-stop, until the service step.

Then the display will show back the time.

11) SETTING AT WORK

After the installation is complete, follow the procedure below:

1. Close the water inlet and outlet taps (fig. 3, B, D), then plug in the fixture.
2. Wait for the time to appear on the display; the valve will be on service step then.
3. Press and hold down the button  for 5 seconds to begin a manual regeneration cycle.
4. Wait for the valve to position on step C1.
5. Unplug the fixture.
6. Slowly open the water inlet by half (fig. 3, D) and leave it in this position for about 5 minutes.
When all the air is out, open the water inlet completely. Let the water flow abundantly until it is crystal clear;
7. Pour some water in the pickle vat and cover the suction pipe (fig. 1);
8. Plug in the fixture again.
9. Press  and  at the same time to run through the following steps of the cycle, until C8.
10. Wait for the valve to complete the cycle (it will only take a few minutes) and to position on service step.
11. Press and hold down  for 5 seconds to begin a manual regeneration cycle.
Wait for a few seconds, and the valve will position on phase C1.
12. Press  and  to pass to step C2, "salt injection". Wait, and make sure that water in the pickle is aspirated through the transparent cup. Water will have to be aspirated completely.
13. Press  and  at the same time to pass to step C5.
14. Let the cycle complete (it will take about 10 minutes).
15. Open the inlet and outlet taps completely (fig. 3, B, D) and close the by pass tap (fig. 3, C).
16. Add salt, up to more than half of the vat.
17. Press  and the regeneration symbol will flash on the display. It's now possible to program a regeneration at a fixed time.

12) ADJUSTING THE MIXER SCREW

The water softener supplies water free of hardness. In some cases, however, a hardness residual in the water can be important.

The mixer allows a certain amount of water to pass directly from the inlet to the outlet of the water softener, without being softened by resins.

Unscrewing the mixer screw (fig. 2, B) you can gradually increase the hardness of the outcoming water.

Please remember that this operation must be carried out very carefully.

At the end of the adjustment, we advise you to let some water flow out and to measure its hardness.

13) RESIN DISINFECTION AND SALT ALARM





On request, the water softener can be provided with an optional device disinfecting the resins during regeneration.

The device consists in a component that will be screwed up to the valve (fig. 8) and connected through a cable to the timer connector (fig. 6, L).

When the device is installed, the timer will activate it automatically and, during the aspiration step (C2), "CL" will appear on the display.

Besides disinfecting the resins, it can also warn the user when the pickle vat has run out of salt. The orange led flashlight under the display will turn on (fig. 9, F, "check salt"), remembering the user to load salt to the pickle vat (fig. 7).

It is possible to activate and deactivate the "salt alarm" function following the procedure below:

- 1) Press and hold down  at the same time, until "P1" appears in the lower part of the display.
- 2) Press and hold down  until you see the P11 parametre.
- 3) Press  and the P11 value will start to flash.
- 4) Press  and select:
 - 0 if you wish to activate the "salt alarm" function.
 - 1 if you want to deactivate it.
- 5) Press  to confirm the set value, P11.

If you want to manually turn off the led flashlight, briefly press the button .

The led will automatically turn off when, during the following regeneration, the salty water will be aspirated again.

14) MAINTENANCE



14.1 FOR THE USER

Maintenance for users only consists in refilling the pickle periodically with sodium chloride (NaCl, common salt), in lack of which the water softener will not be able to eliminate water limy hardness.

ATTENTION! Never use substances different from common salt (NaCl).

14.2 FOR INSTALLERS

For an ideal working, it is advisable to perform the following operations periodically:

- Clean the pickle and remove any sediment from the suction pipe (fig. 1) every six months;
- Clean the injector (fig. 6, B), its filter (fig. 6, D) and the pickle control (fig. 6, C) at least once a year, following the instructions reported below:
 1. Close the water inlet and outlet taps (fig. 3, B, D)
 2. Press and hold down the button  for 5 seconds, to start a manual quick regeneration cycle.
 3. Wait for a few seconds, and check that C1 appears on the display.
 4. Wait for 15 seconds, then unplug the fixture.
 5. Unscrew and remove the ejector (fig. 6, B), the filter (fig. 6, D) and the pickle control (fig. 6, C).
 6. Wash the components with water and make sure the hole in the ejector isn't blocked (fig. 6, B).
 7. Carefully place the parts again in their seats.
 8. Slowly open the water inlet and outlet taps (fig. 3, B, D).
 9. Plug in the fixture again.
 10. Press the buttons  and  at the same time for 5 seconds. The valve will position on service step. The display will then show back the time.

15) USEFUL ADVICE

Experience teaches that, often, malfunctioning of water softeners is caused by an incorrect outlet pipe installation (fig. 4, A). For this reason, we advise you to perform a correct installation (fig. 3, F), using the outlet pipe provided.

Where possible, it is advisable to install a filter before the water softener to get rid of substances that could compromise the good functioning of the fixture.

PROBLEM	SOLUTION
The valve does not regenerate automatically	<ul style="list-style-type: none"> - make sure that the fixture is connected to power supply (fig. 6, G) - check the settings (see "9 Setting the timer")
The valve regenerates at the wrong time	<ul style="list-style-type: none"> - check the current time and regeneration time settings (see "9 Setting the timer")
Pickle is not sucked	<ul style="list-style-type: none"> - make sure network pressure is at least 2 bar - make sure the unloading pipe isn't blocked and doesn't have too narrow elbows flattening the pipe (fig. 4, A) - clean the injector (fig. 6, B) (see "14 Maintenance") - make sure the valve isn't sucking air where there are the quick connections (fig. 6, A)
The pickle vat fills too much	<ul style="list-style-type: none"> - make sure the unloading pipe is not blocked and does not have too narrow elbows flattening the pipe (fig. 4, A) - make sure the valve is not sucking air where there are the quick connections (fig. 6,A) - clean the injector (fig. 6, B) (see "14 Maintenance") - make sure the working pressure is at least 2 bar - check if the "salt amount" value is set to "L" (see "9.6 Measuring out salt for regeneration")
Water softener salt consumption is higher or lower than expected	<ul style="list-style-type: none"> - check if the "salt amount" value is set to "L" (see "9.6 Measuring out salt for regeneration") - check the valve settings (see "9 Setting the timer") (See 9.5 Setting regeneration day)
After regeneration, water is not softened	<ul style="list-style-type: none"> - check the power supply and the valve settings - check the presence of salt in the pickle (fig. 7) - check the correct screwing of the mixer screw (fig. 2, B)
Err1	<p>"The program can't work anymore". Press the button ↑ to reset. If the error signal does not disappear, replace the control.</p>
Err2	<p>Unplug and re-plug in the fixture. If the error does not disappear, it means that the power supply frequency is not 50 or 60 Hz, or the timer is out of order.</p>
Err3	<p>"The control can't get any signal from the cam shaft" Wait for the cam shaft to reach the "service position", and the error signal will disappear. If the error signal does not disappear and the cam shaft keeps rotating, check that the connecting cable between the engine and the control are not damaged (fig. 6, H), and that the optical sensor is the right place (fig. 6, E).</p>