

The Portable Ozone Generator

ENGLISH

Please read the instruction manual carefully
before using the machine.
Please keep it in a safe place
For future reference.

2014

PORTABLE OZONE GENERATOR

CH-KTA/CH-KTB/CH-KTM
CH-BP/CH-BT/CH-BS/CH-ZTW/CH-DP

Instruction Manual

Verson:1.2

Issued Date: 2014-09-04

Catalogue

Device Configuration Function.	2
General Operating Instructions.	3
BP Series Instruction.	4
ZTW Series Instruction.	5
DP Series Instruction.	6
Applications.	8
After-sales Service.	9
Packing List.	9
Appendix.	10
The Portable Ozone Generator Parameters.	10

Appendix

Portable ozone generator parameter

Model	Gas flow rate	Ozone output	Power	Output gas tube	Fuse	Voltage	External Size	Net Weight
	L/mim	g/h	W	mm	A	V\Hz	mm	kg
CH-KTA	10	3	80	Φ6	3	220\50	320×175×265	5.3
CH-KTB	10	5	90				320×160×275	4.8
CH-KTM	10	5	90				320×170×270	5.5
CH-DP	10	5	85				340×175×275	5.8
CH-BS	10	6	110				370×160×295	5.6
CH-BT	10	6	110				365×165×275	6.1

CH-BP—Portable ozone generator

Model	Gas flow rate	Ozone output	Power	Output gas tube	Fuse	Voltage	External Size	Net Weight
	L/mim	g/h	W	mm	A	V\Hz	mm	kg
CH-BP3G	45	3	110	Φ6	3	220\50	390×230×310	8.6
CH-BP5G		5	120					
CH-BP6G		6	140					8.8
CH-BP7G		7	150					

CH-ZTW—Desktop Lab ozone generator

Model	Gas flow rate	Ozone output	Power	Output gas tube	Fuse	Voltage	External Size	Net Weight
	L/mim	g/h	W	mm	A	V\Hz	mm	kg
CH-ZTW3G	1	3	80	Φ6	3	220\50	400×370×150	6.5
CH-ZTW5G	1	5	90					
CH-ZTW6G	2	6	110					6.6
CH-ZTW7G	2	7	120					

1. Above ozone capacity were tested under oxygen source
2. Net weight will be 10% different for different plug. The specific parameter configurations are subject to the real object.

Note: 1. When using aeration stone for water sterilization, put aeration stone sink to the bottom, moving the stone make water aeration uniform.

2. For meat, vegetable or fruit to the water sterilization, the items should be placed in the aeration zone.

3. When using the ejector should be installed in the rear end of the waterway ejector valve, (water through the valve first and then through the ejector)

Other space sterilization Reference Table

No.	Ozone output	Shoe Cabinet	Wardrobe	Bookshelf
1	3g/h	5-8minutes	8-12minutes	5-6minutes
2	5g/h	5-8minutes	8-12minutes	5-6minutes
3	6g/h	3-5minutes	5-8minutes	3-5minutes
4	7g/h	3-5minutes	5-8minutes	3-5minutes

After-sales service

Warranty is one (1) year from the date of purchase

This product undergoes a rigorous test before ex-works. Any fault normal operation conditions will be repaired or replace free of charge by our company with this warranty card after it is checked by our company as the case start from the date of purchase.

Following conditions are not covered by the warranty:

Dismantled by user and did not operate in accordance with instruction listed in instruction manual. The power supply or voltage is altered which leads to the damage of the machine. Damages caused by human factors or natural disasters are not covered by the warranty.

If any part is replaced during repair process, only its material cost is charged and no labor cost charged after warranty ends.

The final interpretation right of the after-sales service and the instruction manual belong to our company.

Packing list

1. Silicon tubing 2M (Including model: KTA\KTB\KTM\BS\BT\BP\DP) ;
Teflon tube 2M (ZTW) ;
2. Air stone 2PCS (Including model: KTA\KTB\KTM\BS\BT\DP) ;
3. Power line 1PCS ;
4. 3A Fuse 2PCS ;
5. Instruction Manual 1PCS.

Device configuration Function

Chuanghuan portable ozone generator is widely used in places where it needs sterilization, disinfection, Eradicate Odor, such as household, business, office, hotel, food processing, etc., the operation is simple and practical.

Stable ozone output is a necessary condition for Sterilization, disinfection, Eradicate Odor. Functional configurations of various models of portable ozone generator are as follows.

Configuration \ Models	KTA	KTB	KTM	BS	BT	BP*	ZTW*	DP*
Ship type power switch	★	★	★	★	★	★	★	—
Film power switch	—	—	—	—	—	—	—	★
Compressor switch	—	—	—	—	—	★	—	—
Ozone output adjustment	★	★	—	★	★	★	★	—
Mechanical timer	★	★	★	★	★	★	—	—
Electronic time controller	—	—	—	—	—	—	★	—
Circulating time control module	—	—	—	—	—	—	—	★
Power indicator light	★	—	★	★	★	★	★	★
Ozone indicator light	★	—	★	★	★	★	★	★
The compressor working indicator light	—	—	—	—	—	★	—	—
The ozone output	★	★	★	★	★	★	★	★
The external gas source input	—	—	—	—	—	★	★	—
The external air flow meter	—	—	—	—	—	—	★	—
Ampere meter	—	—	—	—	—	—	★	—
Remote control	—	—	—	—	—	—	—	★
Anion function	—	—	—	—	—	—	—	—

Noted: Ozone generation output (oxygen source calibration) are: 3 g, 5 g, 6 g, 7 g customers can choose according to their requirements.

General operating instructions

To consider before proceeding

Drop location	Make sure this device is more than 10 cm away from walls or other equipment, do not use the object block or cover the ventilation of the equipment or any openings, or may even cause internal overheating and damage of the equipment or not produce ozone.
	Please place the equipment on a solid, seismic and strong enough to support the weight of the plane. If the device is overturned, may cause the device to an internal component damage.
	do not use this equipment in high humidity, excessive dust, direct sunlight, outdoor or location near sources of heat. Use this equipment in such locations may result in fire, electric shock and impact to produce ozone. Suitable for ambient temperature of 0-35 degrees Celsius, the humidity is 10%-80% (no frost).
	Do not use this equipment on thick mats or rugs, and if the fibers or dust falled into the internals, it might cause a fire.
	Please do not place this equipment in the vicinity of equipment containing magnets or generate magnetic field.
	Do not use flammable sprays near this equipment or placing this equipment in the vicinity of flammable solvents such as alcohol, thinners, etc. If the device is an internal electrical parts come into contact with flammable substances, may result in a fire or electrical shock.
	Place your device out of the place of children's reach
Cleaning and maintenance	Before cleaning the device, you must first turn off the power and unplug the power plug from the electrical outlet. If not closed when cleaning the device or accidentally start the equipment may result in personal injury or damage to your equipment.
	Please use a dry cloth to clean the device, do not use flammable solvents such as alcohol, benzene or thinner to clean the equipment. If the device's internal parts come into contact with flammable solvents, may result in a fire or electrical shock.
	Periodically unplug this device plugs with a dry cloth to wipe the dust from the power plug and socket of dirt.
	Do not attempt to repair, disassemble or modify the device, the device does not have any user-serviceable parts. This equipment contains high-voltage parts, please do not attempt any maintenance action method product brochures did not state. Inappropriate maintenance actions will damage the device or cause a fire, electric shock, and personal injury.
	Do not repair the equipment on their own. When a device fails, please contact your local dealer.
Other metal objects such as paper clips, Staples, or fell into the water, liquids or flammable substances or spilled into the device, and may result in personal injury, electric shock or fire, immediately with a dry hand, please turn off the machine and disconnect the power cord and contact your local dealer.	

Working Mode Option And Setting

1. Working mode option

Short press "SET" key to switch three working models.

Eg: the system default working model F1 (working limited):

1) short press "SET" key to switch to F2-1

2) short press "SET" key to switch to F2-2

3) short press "SET" key to switch to F2-1

Press "confirm" key to choose the working model you want. After finish setting, current working mode is the machine working mode.

2. Working mode setting

Step1: mode option

Power on, short press "SET" to choose the three working mode(F1\F2-1\F2-2), then short press "confirm" key.

Step2: time setting

Long press "SET" key, then after hear long whistle:

Setting hour: short press "SET" key, the "hour" light is flashing. You can press "ADD" or "SUB" key to set hour.

Setting the minutes: short press "SET" key, the "minutes" light is flashing. You can press "ADD" or "SUB" key to set the minutes.

After finish setting, then short press "confirm" key.

Step3: working

Short press "on/off" key, machine works as the mode setting.

Application

Space sterilization Reference Table

No.	Ozone output	Suggested space	Working time
1	3g/h	10m ²	20-30minutes
2	5g/h	10-15m ²	20-30minutes
3	6g/h	15-20m ²	20-30minutes
4	7g/h	15-20m ²	20-30minutes

Water sterilization Reference Table

No.	Ozone output	Water volume	Working time
1	3g/h	10L	10-20minutes
2	5g/h	10L	10-20minutes
3	6g/h	10L	10-15minutes
4	7g/h	10L	10-15minutes

Panel Operation Instruction:

1. "MODE" 3 kinds of working model. F1, F2-1 and F2-2.
 Mode F1 = set a limit work time
 Mode F2-1= work - downtime cycle
 Mode F2-2= downtime-work cycle
2. "Time" Show the running time of each working mode.
3. The power indicator: Work status -- lamp always being on;
 Downtime status-- lamp flashing.
4. Ozone indicator: Downtime status —lamp off, work status—lamp on,
 stop work status —lamp flashing.

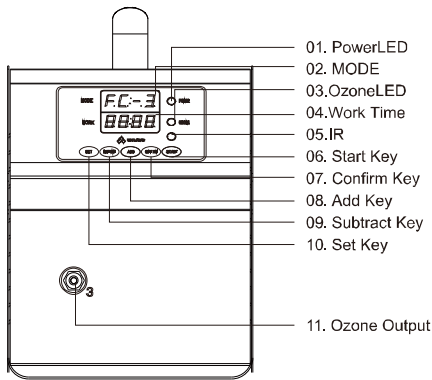

Remote Control

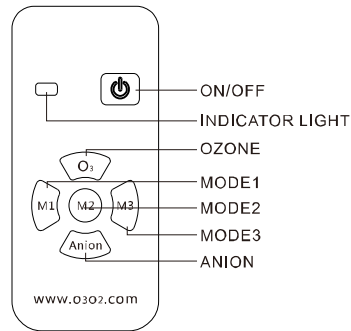

DP models are equipped with the first generation of the remote control, you can select the device remote control mode that corresponds to F1 operation mode MODE1, MODE2 F2-1 corresponding operating mode, MODE3 F2-2 corresponding operating mode. O3 and Anion function keys above applies to the DP Series II models on the remote control.

Panel Function keys instruction:

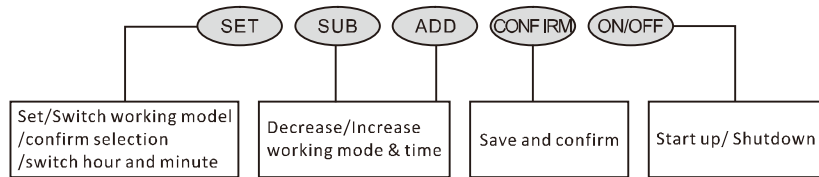



1. Checking status: automatic checking voice (slower beeping); Ozone indicator ("OZONE" Lamp flashing)
2. From 00:01 to 99:59 hours of operation can be set freely.
3. Press optional key to exit and shutdown status.
4. Startup delay time: 15 seconds after startup, ozone output, Ozone indicator light on. Shutdown delay time: 30 seconds before shutdown, no ozone output. Ozone indicator light flashing.



Noted: If Machine operating less than 15 seconds, short press ON/OFF key, machine will stop working, ozone indicator lamp off.

Power supply	When using the device, and must be specified using this equipment is a label the type of power source, otherwise it will cause a fire, electrocution or mechanical failure. If you cannot determine the type of power available, consult your local power company. * Based on the country of the purchased products, the shape of the socket and plug may be different.
	Please do not plug this equipment from the electrical outlet plug when wet. This may result in electric shock.
	Be sure the plug is fully inserted into the power supply socket. If the plug pins into contact with metal objects, and may result in fire or electrical shock.
	Do not damage, modify, stretch, excessive bending or twisting power. Do not place heavy objects on the power cord. These actions could result in a fire or electrical shock.
	Please do not share the outlet with other equipment devices (such as extension cords, such as 2-way or 3-way adapter). This may result in a fire or electrical shock.

Operating Instructions

1. Unscrew the bolted cap on "ozone output" , connect with the equipped corrosion resistance hose , then screw the bolted cap back, lead the hose to the place where need to use ozone.

Attention: Make sure the ozone output hose is smooth, no knot, do not lead the ozone output directly to the human body.

2. Connect power.
3. Turn on "power switch"  (The power supply and ozone indicator on).
4. Set the "timer"  according to need time. Clockwise rotation can be set the time from 0 to 30minutes, when the time is up, the machine will stop working automatically. Anticlockwise rotation to ON, the machine will work continuously. Shut off the power then the machine will stop working.
5. Adjust the "ozone output"  according to the need of ozone production.

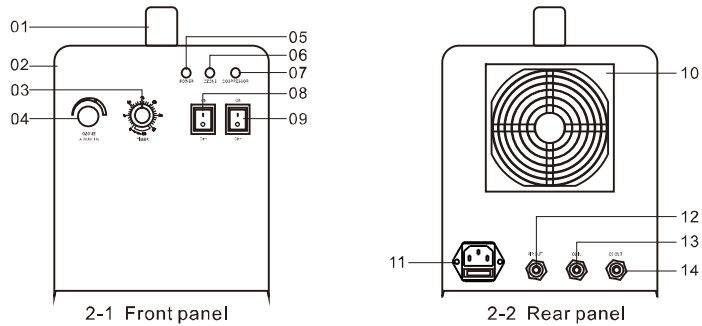

Equipment has been transferred to maximum output before delivery, customers can adjust the ozone output according to the need. Such as the machine with 3g ozone output, it has been set to 100% output before delivery. Customers can anticlockwise the knob to adjust the ozone output to 20%.

BP series operation instructions

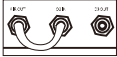

- 1.Handle 2.Box 3.Timer 4.Ozone adjustor 5.Power indicator
6.Ozone indicator 7.Gas source indicator 8.Ozone on/off 9.Gas source on/off
10.Dustproof filter 11.Power line 12.Gas outlet 13.Gas inlet 14.Ozone outlet

1.The machine with its own air source before delivery, Operating mode except in accordance with the "general instructions", you also need to turn on the air source

switch,  Connection as this picture  If need to use external air source (oxygen generator or oxygen tanks), as the picture shown,  connect the

silicone tube with the oxygen generator or oxygen tanks, and turn off the air source switch.

2.When using external air source, the oxygen could not interrupt or stop when the machine is in normal working condition. Please use oxygen pressure reducing valve when using oxygen tanks, strictly prohibit using industrial reducing valve. Because the pressure of oxygen tank will up to 18 mpa. It should install hydrocarbon testing instrument in the gas supply pipe as alarm system to avoid the oxygen tank explosion.

Remarks: The other operating methods please refer to *General Instructions*.

ZTW manual

1.ZTW series of external gas source type. Gas supply should be clean, dry air or

oxygen. As shown , O2 IN connection with the use of silicone hose with

oxygen or gas cylinders, the export of ozone O3 OUT and silicone tube connected to the desired place.

2. The machine in normal working condition, oxygen not interrupt or stop, when using the oxygen source. Should be strictly in accordance with regulations of the like a oxygen for the design and operation of the safety standards. When using oxygen what in oxygen tank as gas source. When using oxygen bomb, please use the oxygen pressure reducing valve, it is forbidden to use industrial pressure reducing valve, due to oxygen 18Mpa pressure for high pressure, To prevent oxygen bomb explosion accident, should be installed in the oxygen supply tube hydrocarbon testing instrument to test for the alarm system.

3. Set the working time:

The word in the middle of timer is H / M / S , represent the hour / minute / second

respectively. The longest time you can set is 99h 99m. When intermediate letters is H, it will show the number of hours on the left, and the number of minutes on the right; when the letter is M, the left is minutes, seconds on the right side.

Working time is preset 30 minutes when the equipment produced, client could reset the needed working time according to the method described above.

Note: other operating methods with reference to "general instructions" section.

